

The Official Samba-3 HOWTO and Reference Guide

Jelmer R. Vernooij, John H. Terpstra, and Gerald (Jerry) Carter

15th December 2004

ATTRIBUTION

Preface and Introduction

- John H. Terpstra <jht@samba.org <mailto:jht@samba.org>>

How to Install and Test SAMBA

- Andrew Tridgell <tridge@samba.org <mailto:tridge@samba.org>>
- Jelmer R. Vernooij <jelmer@samba.org <mailto:jelmer@samba.org>>
- John H. Terpstra <jht@samba.org <mailto:jht@samba.org>>
- Karl Auer <kauer@biplane.com.au <mailto:kauer@biplane.com.au>>
- Dan Shearer <dan@samba.org <mailto:dan@samba.org>>

Fast Start: Cure for Impatience

- John H. Terpstra <jht@samba.org <mailto:jht@samba.org>>

Server Types and Security Modes

- Andrew Tridgell <tridge@samba.org <mailto:tridge@samba.org>>
- Jelmer R. Vernooij <jelmer@samba.org <mailto:jelmer@samba.org>>
- John H. Terpstra <jht@samba.org <mailto:jht@samba.org>>

Domain Control

- John H. Terpstra <jht@samba.org <mailto:jht@samba.org>>
- Gerald (Jerry) Carter <jerry@samba.org <mailto:jerry@samba.org>>
- David Bannon <dbannon@samba.org <mailto:dbannon@samba.org>>
- Guenther Deschner <gd@suse.de <mailto:gd@suse.de>> (LDAP updates)

Backup Domain Control

- John H. Terpstra <jht@samba.org <mailto:jht@samba.org>>
- Volker Lendecke <Volker.Lendecke@SerNet.DE <mailto:Volker.Lendecke@SerNet.DE>>
- Guenther Deschner <gd@suse.de <mailto:gd@suse.de>> (LDAP updates)

Domain Membership

- John H. Terpstra <jht@samba.org <mailto:jht@samba.org>>
- Jeremy Allison <jra@samba.org <mailto:jra@samba.org>>
- Gerald (Jerry) Carter <jerry@samba.org <mailto:jerry@samba.org>>

- Andrew Tridgell <tridge@samba.org <mailto:tridge@samba.org>>
- Jelmer R. Vernooij <jelmer@samba.org <mailto:jelmer@samba.org>>
- Guenther Deschner <gd@suse.de <mailto:gd@suse.de>> (LDAP updates)

Stand-alone Servers

- John H. Terpstra <jht@samba.org <mailto:jht@samba.org>>

MS Windows Network Configuration Guide

- John H. Terpstra <jht@samba.org <mailto:jht@samba.org>>

Network Browsing

- John H. Terpstra <jht@samba.org <mailto:jht@samba.org>>
- Jelmer R. Vernooij <jelmer@samba.org <mailto:jelmer@samba.org>>

Account Information Databases

- Jelmer R. Vernooij <jelmer@samba.org <mailto:jelmer@samba.org>>
- John H. Terpstra <jht@samba.org <mailto:jht@samba.org>>
- Gerald (Jerry) Carter <jerry@samba.org <mailto:jerry@samba.org>>
- Jeremy Allison <jra@samba.org <mailto:jra@samba.org>>
- Guenther Deschner <gd@suse.de <mailto:gd@suse.de>> (LDAP updates)
- Olivier (lem) Lemaire <olem@IDEALX.org <mailto:olem@IDEALX.org>>

Group Mapping MS Windows and UNIX

- John H. Terpstra <jht@samba.org <mailto:jht@samba.org>>
- Jean François Micouleau
- Gerald (Jerry) Carter <jerry@samba.org <mailto:jerry@samba.org>>

Identity Mapping (IDMAP)

- John H. Terpstra <jht@samba.org <mailto:jht@samba.org>>

File, Directory and Share Access Controls

- John H. Terpstra <jht@samba.org <mailto:jht@samba.org>>
- Jeremy Allison <jra@samba.org <mailto:jra@samba.org>>
- Jelmer R. Vernooij <jelmer@samba.org <mailto:jelmer@samba.org>> (drawing)

File and Record Locking

- Jeremy Allison <jra@samba.org <mailto:jra@samba.org>>
- Jelmer R. Vernooij <jelmer@samba.org <mailto:jelmer@samba.org>>
- John H. Terpstra <jht@samba.org <mailto:jht@samba.org>>
- Eric Roseme <eric.roseme@hp.com <mailto:eric.roseme@hp.com>>

Securing Samba

- Andrew Tridgell <tridge@samba.org <mailto:tridge@samba.org>>
- John H. Terpstra <jht@samba.org <mailto:jht@samba.org>>

Interdomain Trust Relationships

- John H. Terpstra <jht@samba.org <mailto:jht@samba.org>>
- Rafal Szczesniak <mimir@samba.org <mailto:mimir@samba.org>>
- Jelmer R. Vernooij <jelmer@samba.org <mailto:jelmer@samba.org>> (drawing)
- Stephen Langasek <vorlon@netexpress.net <mailto:vorlon@netexpress.net>>

Hosting a Microsoft Distributed File System Tree

- Shirish Kalele <samba@samba.org <mailto:samba@samba.org>>
- John H. Terpstra <jht@samba.org <mailto:jht@samba.org>>

Classical Printing Support

- Kurt Pfeifle <kpfeifle@danka.de <mailto:kpfeifle@danka.de>>
- Gerald (Jerry) Carter <jerry@samba.org <mailto:jerry@samba.org>>
- John H. Terpstra <jht@samba.org <mailto:jht@samba.org>>

CUPS Printing Support

- Kurt Pfeifle <kpfeifle@danka.de <mailto:kpfeifle@danka.de>>
- Ciprian Vizitiu <CVizitiu@gbif.org <mailto:CVizitiu@gbif.org>> (drawings)
- Jelmer R. Vernooij <jelmer@samba.org <mailto:jelmer@samba.org>> (drawings)

Stackable VFS modules

- Jelmer R. Vernooij <jelmer@samba.org <mailto:jelmer@samba.org>>
- John H. Terpstra <jht@samba.org <mailto:jht@samba.org>>
- Tim Potter <tpot@samba.org <mailto:tpot@samba.org>>
- Simo Sorce (original vfs_skel README)
- Alexander Bokovoy (original vfs_netatalk docs)
- Stefan Metzmacher (Update for multiple modules)
- Ed Riddle (original shadow_copy docs)

Winbind: Use of Domain Accounts

- Tim Potter <tpot@linuxcare.com.au <mailto:tpot@linuxcare.com.au>>
- Andrew Tridgell <tridge@samba.org <mailto:tridge@samba.org>>
- Naag Mummaneni <getnag@rediffmail.com <mailto:getnag@rediffmail.com>> (Notes for Solaris)

- John Trostel <jtrostel@snapserver.com <mailto:jtrostel@snapserver.com>>
- Jelmer R. Vernooij <jelmer@samba.org <mailto:jelmer@samba.org>>
- John H. Terpstra <jht@samba.org <mailto:jht@samba.org>>

Advanced Network Management

- John H. Terpstra <jht@samba.org <mailto:jht@samba.org>>

System and Account Policies

- John H. Terpstra <jht@samba.org <mailto:jht@samba.org>>

Desktop Profile Management

- John H. Terpstra <jht@samba.org <mailto:jht@samba.org>>

PAM-Based Distributed Authentication

- John H. Terpstra <jht@samba.org <mailto:jht@samba.org>>
- Stephen Langasek <vorlon@netexpress.net <mailto:vorlon@netexpress.net>>

Integrating MS Windows Networks with Samba

- John H. Terpstra <jht@samba.org <mailto:jht@samba.org>>

Unicode/Charsets

- Jelmer R. Vernooij <jelmer@samba.org <mailto:jelmer@samba.org>>
- John H. Terpstra <jht@samba.org <mailto:jht@samba.org>>
- TAKAHASHI Motonobu <monyoy@home.monoyo.com <mailto:monyoy@home.monoyo.com>> (Japanese character support)

Backup Techniques

- John H. Terpstra <jht@samba.org <mailto:jht@samba.org>>

High Availability

- John H. Terpstra <jht@samba.org <mailto:jht@samba.org>>
- Jeremy Allison <jra@samba.org <mailto:jra@samba.org>>

Upgrading from Samba-2.x to Samba-3.0.0

- Jelmer R. Vernooij <jelmer@samba.org <mailto:jelmer@samba.org>>
- John H. Terpstra <jht@samba.org <mailto:jht@samba.org>>
- Gerald (Jerry) Carter <jerry@samba.org <mailto:jerry@samba.org>>

Migration from NT4 PDC to Samba-3 PDC

- John H. Terpstra <jht@samba.org <mailto:jht@samba.org>>

SWAT The Samba Web Administration Tool

- John H. Terpstra <jht@samba.org <mailto:jht@samba.org>>

The Samba Checklist

- Andrew Tridgell <tridge@samba.org <mailto:tridge@samba.org>>
- Jelmer R. Vernooij <jelmer@samba.org <mailto:jelmer@samba.org>>
- Dan Shearer <dan@samba.org <mailto:dan@samba.org>>

Analyzing and Solving Samba Problems

- Gerald (Jerry) Carter <jerry@samba.org <mailto:jerry@samba.org>>
- Jelmer R. Vernooij <jelmer@samba.org <mailto:jelmer@samba.org>>
- David Bannon <dbannon@samba.org <mailto:dbannon@samba.org>>
- Dan Shearer <dan@samba.org <mailto:dan@samba.org>>

Reporting Bugs

- John H. Terpstra <jht@samba.org <mailto:jht@samba.org>>
- Jelmer R. Vernooij <jelmer@samba.org <mailto:jelmer@samba.org>>
- Andrew Tridgell <tridge@samba.org <mailto:tridge@samba.org>>

How to Compile Samba

- Jelmer R. Vernooij <jelmer@samba.org <mailto:jelmer@samba.org>>
- John H. Terpstra <jht@samba.org <mailto:jht@samba.org>>
- Andrew Tridgell <tridge@samba.org <mailto:tridge@samba.org>>

Portability

- Jelmer R. Vernooij <jelmer@samba.org <mailto:jelmer@samba.org>>
- John H. Terpstra <jht@samba.org <mailto:jht@samba.org>>

Samba and Other CIFS Clients

- Jelmer R. Vernooij <jelmer@samba.org <mailto:jelmer@samba.org>>
- John H. Terpstra <jht@samba.org <mailto:jht@samba.org>>
- Dan Shearer <dan@samba.org <mailto:dan@samba.org>>
- Jim McDonough <jmcd@us.ibm.com <mailto:jmcd@us.ibm.com>> (OS/2)

Samba Performance Tuning

- Paul Cochrane <paulc@dth.scot.nhs.uk <mailto:paulc@dth.scot.nhs.uk>>
- Jelmer R. Vernooij <jelmer@samba.org <mailto:jelmer@samba.org>>
- John H. Terpstra <jht@samba.org <mailto:jht@samba.org>>

DNS and DHCP Configuration Guide

- John H. Terpstra <jht@samba.org <mailto:jht@samba.org>>

ABSTRACT

The editors wish to thank you for your decision to purchase this book. The Official Samba-3 HOWTO and Reference Guide is the result of many years of accumulation of information, feedback, tips, hints, and happy solutions.

Please note that this book is a living document, the contents of which are constantly being updated. We encourage you to contribute your tips, techniques, helpful hints, and your special insight into the Windows networking world to help make the next generation of this book even more valuable to Samba users.

We have made a concerted effort to document more comprehensively than has been done previously the information that may help you to better deploy Samba and to gain more contented network users.

This book provides example configurations, it documents key aspects of Microsoft Windows networking, provides in-depth insight into the important configuration of Samba-3, and helps to put all of these into a useful framework.

The most recent electronic versions of this document can be found at <http://www.samba.org/> on the “*Documentation*” page.

Updates, patches and corrections are most welcome. Please email your contributions to any one of the following:

Jelmer Vernooij (jelmer@samba.org) <mailto:jelmer@samba.org>

John H. Terpstra (jht@samba.org) <mailto:jht@samba.org>

Gerald (Jerry) Carter (jerry@samba.org) <mailto:jerry@samba.org>

We wish to advise that only original and unencumbered material can be published. Please do not submit content that is not your own work unless proof of consent from the copyright holder accompanies your submission.

FOREWORD

Over the last few years, the Samba project has undergone a major transformation. From a small project used only by people who dream in machine code, Samba has grown to be an integral part of the IT infrastructure of many businesses. Along with the growth in the popularity of Samba there has been a corresponding growth in the ways that it can be used, and a similar growth in the number of configuration options and the interactions between them.

To address this increasing complexity a wealth of documentation has been written on Samba, including numerous HOWTOs, diagnostic tips, manual pages, and explanations of important pieces of technology that Samba relies on. While it has been gratifying to see so much documentation being written, the sheer volume of different types of documentation has proved difficult to navigate, thus reducing its value to system administrators trying to cope with the complexity.

This book gathers together that wealth of information into a much more accessible form, to allow system administrators to quickly find what they need. The breadth of technical information provided ensures that even the most demanding administrators will find something helpful.

I am delighted that the Samba documentation has now developed to the extent that it can be presented usefully as a book, and I am grateful for the efforts of the many people who have contributed so much toward this result. Enjoy!

Andrew Tridgell
President, Samba Team
July 2003

CONTENTS

Contents

ATTRIBUTION	v
ABSTRACT	xi
FOREWORD	xiii
LIST OF FIGURES	xxxv
LIST OF TABLES	xxxvii
PREFACE AND INTRODUCTION	xxxix
Part I General Installation	xli
PREPARING SAMBA FOR CONFIGURATION	1
Chapter 1 HOW TO INSTALL AND TEST SAMBA	2
1.1 Obtaining and Installing Samba	2
1.2 Configuring Samba (smb.conf)	2
1.2.1 Configuration file syntax	2
1.2.2 Starting Samba	3
1.2.3 Example Configuration	3
1.2.3.1 Test Your Config File with testparm	4
1.2.4 SWAT	4
1.3 List Shares Available on the Server	5
1.4 Connect with a UNIX Client	5
1.5 Connect from a Remote SMB Client	5
1.6 What If Things Don't Work?	6
1.7 Common Errors	6
1.7.1 Large Number of smbd Processes	6
1.7.2 Error Message: open_oplock_ipc	6
1.7.3 <i>"The network name cannot be found"</i>	7
Chapter 2 FAST START: CURE FOR IMPATIENCE	8
2.1 Features and Benefits	8
2.2 Description of Example Sites	8
2.3 Worked Examples	9
2.3.1 Stand-alone Server	9
2.3.1.1 Anonymous Read-Only Document Server	9
2.3.1.2 Anonymous Read-Write Document Server	11
2.3.1.3 Anonymous Print Server	11
	xv

2.3.1.4	Secure Read-Write File and Print Server	13
2.3.2	Domain Member Server	16
2.3.2.1	Example Configuration	17
2.3.3	Domain Controller	20
2.3.3.1	Example: Engineering Office	21
2.3.3.2	A Big Organization	22
 Part II Server Configuration Basics		27
 FIRST STEPS IN SERVER CONFIGURATION		29
 Chapter 3 SERVER TYPES AND SECURITY MODES		30
3.1	Features and Benefits	30
3.2	Server Types	31
3.3	Samba Security Modes	31
3.3.1	User Level Security	32
3.3.1.1	Example Configuration	32
3.3.2	Share Level Security	32
3.3.2.1	Example Configuration	33
3.3.3	Domain Security Mode (User Level Security)	33
3.3.3.1	Example Configuration	33
3.3.4	ADS Security Mode (User Level Security)	34
3.3.4.1	Example Configuration	34
3.3.5	Server Security (User Level Security)	35
3.3.5.1	Example Configuration	36
3.4	Password Checking	36
3.5	Common Errors	37
3.5.1	What Makes Samba a Server?	38
3.5.2	What Makes Samba a Domain Controller?	38
3.5.3	What Makes Samba a Domain Member?	38
3.5.4	Constantly Losing Connections to Password Server	38
 Chapter 4 DOMAIN CONTROL		39
4.1	Features and Benefits	40
4.2	Basics of Domain Control	42
4.2.1	Domain Controller Types	42
4.2.2	Preparing for Domain Control	43
4.3	Domain Control — Example Configuration	46
4.4	Samba ADS Domain Control	47
4.5	Domain and Network Logon Configuration	48
4.5.1	Domain Network Logon Service	48
4.5.1.1	Example Configuration	48
4.5.1.2	The Special Case of MS Windows XP Home Edition	48
4.5.1.3	The Special Case of Windows 9x/Me	49
4.5.2	Security Mode and Master Browsers	51
4.6	Common Errors	51
4.6.1	“\$” Cannot Be Included in Machine Name	51

4.6.2	Joining Domain Fails Because of Existing Machine Account	52
4.6.3	The System Cannot Log You On (C000019B)	52
4.6.4	The Machine Trust Account Is Not Accessible	53
4.6.5	Account Disabled	53
4.6.6	Domain Controller Unavailable	53
4.6.7	Cannot Log onto Domain Member Workstation After Joining Domain	53
Chapter 5	BACKUP DOMAIN CONTROL	55
5.1	Features and Benefits	55
5.2	Essential Background Information	56
5.2.1	MS Windows NT4-style Domain Control	57
5.2.1.1	Example PDC Configuration	58
5.2.2	LDAP Configuration Notes	58
5.2.3	Active Directory Domain Control	59
5.2.4	What Qualifies a Domain Controller on the Network?	60
5.2.5	How does a Workstation find its Domain Controller?	60
5.2.5.1	NetBIOS Over TCP/IP Enabled	60
5.2.5.2	NetBIOS Over TCP/IP Disabled	60
5.3	Backup Domain Controller Configuration	60
5.3.1	Example Configuration	61
5.4	Common Errors	62
5.4.1	Machine Accounts Keep Expiring	62
5.4.2	Can Samba Be a Backup Domain Controller to an NT4 PDC?	63
5.4.3	How Do I Replicate the smbpasswd File?	63
5.4.4	Can I Do This All with LDAP?	63
Chapter 6	DOMAIN MEMBERSHIP	64
6.1	Features and Benefits	64
6.2	MS Windows Workstation/Server Machine Trust Accounts	65
6.2.1	Manual Creation of Machine Trust Accounts	66
6.2.2	Managing Domain Machine Accounts using NT4 Server Manager	67
6.2.3	On-the-Fly Creation of Machine Trust Accounts	68
6.2.4	Making an MS Windows Workstation or Server a Domain Member	68
6.2.4.1	Windows 200x/XP Professional Client	68
6.2.4.2	Windows NT4 Client	69
6.2.4.3	Samba Client	69
6.3	Domain Member Server	69
6.3.1	Joining an NT4-type Domain with Samba-3	69
6.3.2	Why Is This Better Than security = server?	71
6.4	Samba ADS Domain Membership	72
6.4.1	Configure smb.conf	72
6.4.2	Configure /etc/krb5.conf	73
6.4.3	Create the Computer Account	74
6.4.3.1	Possible Errors	76
6.4.4	Testing Server Setup	76
6.4.5	Testing with smbclient	76
6.4.6	Notes	76
6.5	Sharing User ID Mappings between Samba Domain Members	77

6.6	Common Errors	77
6.6.1	Cannot Add Machine Back to Domain	77
6.6.2	Adding Machine to Domain Fails	77
6.6.3	I Can't Join a Windows 2003 PDC	78
Chapter 7	STAND-ALONE SERVERS	79
7.1	Features and Benefits	79
7.2	Background	79
7.3	Example Configuration	80
7.3.1	Reference Documentation Server	80
7.3.2	Central Print Serving	81
7.4	Common Errors	82
Chapter 8	MS WINDOWS NETWORK CONFIGURATION GUIDE	83
8.1	Features and Benefits	83
8.2	Technical Details	83
8.2.1	TCP/IP Configuration	83
8.2.1.1	MS Windows XP Professional	84
8.2.1.2	MS Windows 2000	85
8.2.1.3	MS Windows Me	87
8.2.2	Joining a Domain: Windows 2000/XP Professional	89
8.2.3	Domain Logon Configuration: Windows 9x/Me	90
8.3	Common Errors	91
Part III	Advanced Configuration	99
VALUABLE NUTS AND BOLTS INFORMATION		101
Chapter 9	NETWORK BROWSING	102
9.1	Features and Benefits	102
9.2	What Is Browsing?	103
9.3	Discussion	104
9.3.1	NetBIOS over TCP/IP	104
9.3.2	TCP/IP without NetBIOS	105
9.3.3	DNS and Active Directory	106
9.4	How Browsing Functions	108
9.4.1	Configuring WORKGROUP Browsing	109
9.4.2	DOMAIN Browsing Configuration	110
9.4.3	Forcing Samba to Be the Master	111
9.4.4	Making Samba the Domain Master	112
9.4.5	Note about Broadcast Addresses	112
9.4.6	Multiple Interfaces	112
9.4.7	Use of the Remote Announce Parameter	113
9.4.8	Use of the Remote Browse Sync Parameter	113
9.5	WINS — The Windows Inter-networking Name Server	113
9.5.1	WINS Server Configuration	114
9.5.2	WINS Replication	115
9.5.3	Static WINS Entries	115

9.6	Helpful Hints	116
9.6.1	Windows Networking Protocols	116
9.6.2	Name Resolution Order	117
9.7	Technical Overview of Browsing	117
9.7.1	Browsing Support in Samba	118
9.7.2	Problem Resolution	118
9.7.3	Cross-Subnet Browsing	119
9.7.3.1	Behavior of Cross-Subnet Browsing	119
9.8	Common Errors	122
9.8.1	How Can One Flush the Samba NetBIOS Name Cache without Restarting Samba?	122
9.8.2	Server Resources Can Not Be Listed	123
9.8.3	I get an 'Unable to browse the network' error	123
9.8.4	Browsing of Shares and Directories is Very Slow	123
Chapter 10	ACCOUNT INFORMATION DATABASES	125
10.1	Features and Benefits	125
10.1.1	Backward Compatibility Backends	126
10.1.2	New Backends	126
10.2	Technical Information	127
10.2.1	Important Notes About Security	128
10.2.1.1	Advantages of Encrypted Passwords	130
10.2.1.2	Advantages of Non-Encrypted Passwords	130
10.2.2	Mapping User Identifiers between MS Windows and UNIX	130
10.2.3	Mapping Common UIDs/GIDs on Distributed Machines	131
10.3	Account Management Tools	131
10.3.1	The <i>smbpasswd</i> Command	131
10.3.2	The <i>pdbedit</i> Command	132
10.4	Password Backends	134
10.4.1	Plaintext	134
10.4.2	smbpasswd — Encrypted Password Database	134
10.4.3	tdbsam	135
10.4.4	ldapsam	135
10.4.4.1	Supported LDAP Servers	136
10.4.4.2	Schema and Relationship to the RFC 2307 posixAccount	136
10.4.4.3	OpenLDAP Configuration	136
10.4.4.4	Initialize the LDAP Database	138
10.4.4.5	Configuring Samba	140
10.4.4.6	Accounts and Groups Management	141
10.4.4.7	Security and sambaSamAccount	141
10.4.4.8	LDAP Special Attributes for sambaSamAccounts	142
10.4.4.9	Example LDIF Entries for a sambaSamAccount	142
10.4.4.10	Password Synchronization	143
10.4.5	MySQL	143
10.4.5.1	Creating the Database	143
10.4.5.2	Configuring	144
10.4.5.3	Using Plaintext Passwords or Encrypted Password	144
10.4.5.4	Getting Non-Column Data from the Table	145

10.4.6 XML	145
10.5 Common Errors	145
10.5.1 Users Cannot Logon	145
10.5.2 Users Being Added to the Wrong Backend Database	146
10.5.3 Configuration of auth methods	146
Chapter 11 GROUP MAPPING — MS WINDOWS AND UNIX	150
11.1 Features and Benefits	150
11.2 Discussion	152
11.2.1 Important Administrative Information	153
11.2.2 Default Users, Groups and Relative Identifiers	153
11.2.3 Example Configuration	155
11.3 Configuration Scripts	155
11.3.1 Sample smb.conf Add Group Script	155
11.3.2 Script to Configure Group Mapping	156
11.4 Common Errors	156
11.4.1 Adding Groups Fails	157
11.4.2 Adding MS Windows Groups to MS Windows Groups Fails	157
11.4.3 Adding <i>Domain Users</i> to the <i>Power Users</i> Group	157
Chapter 12 IDENTITY MAPPING (IDMAP)	158
12.1 Samba Server Deployment Types and IDMAP	158
12.1.1 Stand-Alone Samba Server	158
12.1.2 Domain Member Server or Domain Member Client	159
12.1.3 Primary Domain Controller	161
12.1.4 Backup Domain Controller	161
12.2 Examples of IDMAP Backend Usage	162
12.2.1 Default Winbind TDB	162
12.2.1.1 NT4 Style Domains (includes Samba Domains)	162
12.2.1.2 ADS Domains	163
12.2.2 IDMAP_RID with Winbind	164
12.2.3 IDMAP Storage in LDAP using Winbind	166
12.2.4 IDMAP and NSS Using LDAP From ADS with RFC2307bis Schema Extension	169
12.2.4.1 IDMAP, Active Directory and MS Services for UNIX 3.5	170
12.2.4.2 IDMAP, Active Directory and AD4UNIX	170
Chapter 13 FILE, DIRECTORY AND SHARE ACCESS CONTROLS	171
13.1 Features and Benefits	172
13.2 File System Access Controls	172
13.2.1 MS Windows NTFS Comparison with UNIX File Systems	172
13.2.2 Managing Directories	174
13.2.3 File and Directory Access Control	174
13.3 Share Definition Access Controls	176
13.3.1 User and Group-Based Controls	176
13.3.2 File and Directory Permissions-Based Controls	176
13.3.3 Miscellaneous Controls	177
13.4 Access Controls on Shares	177

13.4.1	Share Permissions Management	178
13.4.1.1	Windows NT4 Workstation/Server	179
13.4.1.2	Windows 200x/XP	180
13.5	MS Windows Access Control Lists and UNIX Interoperability	181
13.5.1	Managing UNIX Permissions Using NT Security Dialogs	181
13.5.2	Viewing File Security on a Samba Share	181
13.5.3	Viewing File Ownership	181
13.5.4	Viewing File or Directory Permissions	182
13.5.4.1	File Permissions	182
13.5.4.2	Directory Permissions	183
13.5.5	Modifying File or Directory Permissions	183
13.5.6	Interaction with the Standard Samba “ <i>create mask</i> ” Parameters	184
13.5.7	Interaction with the Standard Samba File Attribute Mapping	185
13.6	Common Errors	185
13.6.1	Users Cannot Write to a Public Share	185
13.6.2	File Operations Done as <i>root</i> with <i>force user</i> Set	187
13.6.3	MS Word with Samba Changes Owner of File	187
Chapter 14 FILE AND RECORD LOCKING		189
14.1	Features and Benefits	189
14.2	Discussion	190
14.2.1	Opportunistic Locking Overview	190
14.2.1.1	Exclusively Accessed Shares	192
14.2.1.2	Multiple-Accessed Shares or Files	193
14.2.1.3	UNIX or NFS Client-Accessed Files	193
14.2.1.4	Slow and/or Unreliable Networks	193
14.2.1.5	Multi-User Databases	193
14.2.1.6	PDM Data Shares	193
14.2.1.7	Beware of Force User	194
14.2.1.8	Advanced Samba Opportunistic Locking Parameters	194
14.2.1.9	Mission-Critical High-Availability	194
14.3	Samba Opportunistic Locking Control	195
14.3.1	Example Configuration	196
14.3.1.1	Disabling Oplocks	196
14.3.1.2	Disabling Kernel Oplocks	196
14.4	MS Windows Opportunistic Locking and Caching Controls	197
14.4.1	Workstation Service Entries	200
14.4.2	Server Service Entries	200
14.5	Persistent Data Corruption	201
14.6	Common Errors	201
14.6.1	locking.tdb Error Messages	202
14.6.2	Problems Saving Files in MS Office on Windows XP	202
14.6.3	Long Delays Deleting Files Over Network with XP SP1	202
14.7	Additional Reading	202
Chapter 15 SECURING SAMBA		204
15.1	Introduction	204
15.2	Features and Benefits	204

15.3	Technical Discussion of Protective Measures and Issues	205
15.3.1	Using Host-Based Protection	205
15.3.2	User-Based Protection	205
15.3.3	Using Interface Protection	205
15.3.4	Using a Firewall	206
15.3.5	Using IPC\$ Share-Based Denials	206
15.3.6	NTLMv2 Security	207
15.4	Upgrading Samba	207
15.5	Common Errors	207
15.5.1	Smbclient Works on Localhost, but the Network Is Dead	207
15.5.2	Why Can Users Access Home Directories of Other Users?	208
Chapter 16	INTERDOMAIN TRUST RELATIONSHIPS	209
16.1	Features and Benefits	209
16.2	Trust Relationship Background	210
16.3	Native MS Windows NT4 Trusts Configuration	210
16.3.1	Creating an NT4 Domain Trust	210
16.3.2	Completing an NT4 Domain Trust	211
16.3.3	Inter-Domain Trust Facilities	211
16.4	Configuring Samba NT-Style Domain Trusts	212
16.4.1	Samba as the Trusted Domain	212
16.4.2	Samba as the Trusting Domain	213
16.5	NT4-Style Domain Trusts with Windows 2000	214
16.6	Common Errors	214
16.6.1	Browsing of Trusted Domain Fails	214
16.6.2	Problems With LDAP ldapsam And The smbldap-tools	215
Chapter 17	HOSTING A MICROSOFT DISTRIBUTED FILE SYSTEM TREE	216
17.1	Features and Benefits	216
17.2	Common Errors	217
17.2.1	MSDFS UNIX Path Is Case-Critical	217
Chapter 18	CLASSICAL PRINTING SUPPORT	219
18.1	Features and Benefits	219
18.2	Technical Introduction	220
18.2.1	Client to Samba Print Job Processing	220
18.2.2	Printing Related Configuration Parameters	221
18.3	Simple Print Configuration	221
18.3.1	Verifying Configuration with testparm	222
18.3.2	Rapid Configuration Validation	223
18.4	Extended Printing Configuration	225
18.4.1	Detailed Explanation Settings	226
18.4.1.1	The [global] Section	226
18.4.1.2	The [printers] Section	228
18.4.1.3	Any [my_printer_name] Section	229
18.4.1.4	Print Commands	230
18.4.1.5	Default UNIX System Printing Commands	230

18.4.1.6	Custom Print Commands	231
18.5	Printing Developments Since Samba-2.2	232
18.5.1	Point'n'Print Client Drivers on Samba Servers	233
18.5.2	The Obsolete [printer\$] Section	234
18.5.3	Creating the [print\$] Share	234
18.5.4	[print\$] Section Parameters	234
18.5.5	The [print\$] Share Directory	236
18.6	Installing Drivers into [print\$]	237
18.6.1	Add Printer Wizard Driver Installation	237
18.6.2	Installing Print Drivers Using rpcclient	238
18.6.2.1	Identifying Driver Files	238
18.6.2.2	Obtaining Driver Files from Windows Client [print\$] Shares	240
18.6.2.3	Installing Driver Files into [print\$]	241
18.6.2.4	smbclient to Confirm Driver Installation	242
18.6.2.5	Running rpcclient with adddriver	243
18.6.2.6	Checking adddriver Completion	244
18.6.2.7	Check Samba for Driver Recognition	245
18.6.2.8	Specific Driver Name Flexibility	246
18.6.2.9	Running rpcclient with the setdriver	246
18.7	Client Driver Installation Procedure	247
18.7.1	First Client Driver Installation	247
18.7.2	Setting Device Modes on New Printers	248
18.7.3	Additional Client Driver Installation	250
18.7.4	Always Make First Client Connection as root or " <i>printer admin</i> "	250
18.8	Other Gotchas	251
18.8.1	Setting Default Print Options for Client Drivers	251
18.8.2	Supporting Large Numbers of Printers	252
18.8.3	Adding New Printers with the Windows NT APW	254
18.8.4	Error Message: " <i>Cannot connect under a different Name</i> "	255
18.8.5	Take Care When Assembling Driver Files	256
18.8.6	Samba and Printer Ports	259
18.8.7	Avoiding Common Client Driver Mis-configuration	259
18.9	The Imprints Tool-set	259
18.9.1	What is Imprints?	259
18.9.2	Creating Printer Driver Packages	260
18.9.3	The Imprints Server	260
18.9.4	The Installation Client	260
18.10	Adding Network Printers without User Interaction	261
18.11	The addprinter Command	262
18.12	Migration of Classical Printing to Samba	263
18.13	Publishing Printer Information in Active Directory or LDAP	263
18.14	Common Errors	264
18.14.1	I Give My Root Password but I Do Not Get Access	264
18.14.2	My Print Jobs Get Spooled into the Spooling Directory, but Then Get Lost	264
Chapter 19	CUPS PRINTING SUPPORT	265
19.1	Introduction	265

19.1.1	Features and Benefits	265
19.1.2	Overview	265
19.2	Basic CUPS Support Configuration	266
19.2.1	Linking <code>smbd</code> with <code>libcups.so</code>	266
19.2.2	Simple <code>smb.conf</code> Settings for CUPS	267
19.2.3	More Complex CUPS <code>smb.conf</code> Settings	268
19.3	Advanced Configuration	269
19.3.1	Central Spooling vs. “Peer-to-Peer” Printing	269
19.3.2	Raw Print Serving — Vendor Drivers on Windows Clients	269
19.3.3	Installation of Windows Client Drivers	270
19.3.4	Explicitly Enable “raw” Printing for <i>application/octet-stream</i>	270
19.3.5	Driver Upload Methods	271
19.4	Advanced Intelligent Printing with PostScript Driver Download	272
19.4.1	GDI on Windows – PostScript on UNIX	272
19.4.2	Windows Drivers, GDI and EMF	272
19.4.3	UNIX Printfile Conversion and GUI Basics	273
19.4.4	PostScript and Ghostscript	274
19.4.5	Ghostscript — the Software RIP for Non-PostScript Printers	275
19.4.6	PostScript Printer Description (PPD) Specification	276
19.4.7	Using Windows-Formatted Vendor PPDs	277
19.4.8	CUPS Also Uses PPDs for Non-PostScript Printers	278
19.5	The CUPS Filtering Architecture	278
19.5.1	MIME Types and CUPS Filters	279
19.5.2	MIME Type Conversion Rules	280
19.5.3	Filtering Overview	281
19.5.3.1	Filter requirements	281
19.5.4	Prefilters	281
19.5.5	<code>pstops</code>	282
19.5.6	<code>pstoraster</code>	283
19.5.7	<code>imagetops</code> and <code>imageraster</code>	284
19.5.8	<code>rasterto</code> [printers specific]	285
19.5.9	CUPS Backends	285
19.5.10	The Role of <code>cupsonomatic/foomatic</code>	287
19.5.11	The Complete Picture	287
19.5.12	<code>mime.convs</code>	288
19.5.13	“Raw” Printing	288
19.5.14	<i>application/octet-stream</i> Printing	288
19.5.15	PostScript Printer Descriptions (PPDs) for Non-PS Printers	290
19.5.16	<i>cupsonomatic/foomatic-rip</i> Versus <i>native CUPS</i> Printing	291
19.5.17	Examples for Filtering Chains	292
19.5.18	Sources of CUPS Drivers/PPDs	293
19.5.19	Printing with Interface Scripts	294
19.6	Network Printing (Purely Windows)	294
19.6.1	From Windows Clients to an NT Print Server	294
19.6.2	Driver Execution on the Client	295
19.6.3	Driver Execution on the Server	295
19.7	Network Printing (Windows Clients — UNIX/Samba Print Servers)	295
19.7.1	From Windows Clients to a CUPS/Samba Print Server	296

19.7.2 Samba Receiving Job-files and Passing Them to CUPS	296
19.8 Network PostScript RIP	297
19.8.1 PPDs for Non-PS Printers on UNIX	298
19.8.2 PPDs for Non-PS Printers on Windows	298
19.9 Windows Terminal Servers (WTS) as CUPS Clients	298
19.9.1 Printer Drivers Running in “ <i>Kernel Mode</i> ” Cause Many Problems	298
19.9.2 Workarounds Impose Heavy Limitations	299
19.9.3 CUPS: A “ <i>Magical Stone</i> ”?	299
19.9.4 PostScript Drivers with No Major Problems — Even in Kernel Mode	299
19.10 Configuring CUPS for Driver Download	300
19.10.1 <i>cupsaddsmb</i> : The Unknown Utility	300
19.10.2 Prepare Your smb.conf for cupsaddsmb	300
19.10.3 CUPS “ <i>PostScript Driver for Windows NT/200x/XP</i> ”	300
19.10.4 Recognizing Different Driver Files	302
19.10.5 Acquiring the Adobe Driver Files	303
19.10.6 ESP Print Pro PostScript Driver for Windows NT/200x/XP	303
19.10.7 Caveats to be Considered	304
19.10.8 Windows CUPS PostScript Driver Versus Adobe Driver	305
19.10.9 Run cupsaddsmb (Quiet Mode)	306
19.10.10 Run cupsaddsmb with Verbose Output	306
19.10.11 Understanding cupsaddsmb	308
19.10.12 How to Recognize If cupsaddsmb Completed Successfully	309
19.10.13 cupsaddsmb with a Samba PDC	310
19.10.14 cupsaddsmb Flowchart	310
19.10.15 Installing the PostScript Driver on a Client	310
19.10.16 Avoiding Critical PostScript Driver Settings on the Client	311
19.11 Installing PostScript Driver Files Manually Using rpcclient	312
19.11.1 A Check of the rpcclient man Page	312
19.11.2 Understanding the rpcclient man Page	313
19.11.3 Producing an Example by Querying a Windows Box	314
19.11.4 Requirements for adddriver and setdriver to Succeed	315
19.11.5 Manual Driver Installation in 15 Steps	315
19.11.6 Troubleshooting Revisited	320
19.12 The Printing *.tdb Files	321
19.12.1 Trivial Database Files	321
19.12.2 Binary Format	322
19.12.3 Losing *.tdb Files	322
19.12.4 Using tdbbackup	322
19.13 CUPS Print Drivers from Linuxprinting.org	323
19.13.1 foomatic-rip and Foomatic Explained	323
19.13.1.1 690 “ <i>Perfect</i> ” Printers	324
19.13.1.2 How the Printing HOWTO Started It All	324
19.13.1.3 Foomatic’s Strange Name	324
19.13.1.4 cupsomatic, pdqomatic, lpdomatic, directomatic	325
19.13.1.5 The <i>Grand Unification</i> Achieved	325
19.13.1.6 Driver Development Outside	326
19.13.1.7 Forums, Downloads, Tutorials, Howtos — also for Mac OS X and Commercial UNIX	327

19.13.1.8 Foomatic Database-Generated PPDs	327
19.13.2 foomatic-rip and Foomatic-PPD Download and Installation	328
19.14 Page Accounting with CUPS	330
19.14.1 Setting Up Quotas	330
19.14.2 Correct and Incorrect Accounting	330
19.14.3 Adobe and CUPS PostScript Drivers for Windows Clients	331
19.14.4 The page_log File Syntax	331
19.14.5 Possible Shortcomings	332
19.14.6 Future Developments	332
19.15 Additional Material	333
19.16 Auto-Deletion or Preservation of CUPS Spool Files	334
19.16.1 CUPS Configuration Settings Explained	334
19.16.2 Pre-Conditions	335
19.16.3 Manual Configuration	335
19.17 Printing from CUPS to Windows Attached Printers	335
19.18 More CUPS-Filtering Chains	337
19.19 Common Errors	337
19.19.1 Windows 9x/ME Client Can't Install Driver	337
19.19.2 " <i>cupsaddsmb</i> " Keeps Asking for Root Password in Never-ending Loop	337
19.19.3 " <i>cupsaddsmb</i> " Errors	338
19.19.4 Client Can't Connect to Samba Printer	339
19.19.5 New Account Reconnection from Windows 200x/XP Troubles	339
19.19.6 Avoid Being Connected to the Samba Server as the Wrong User	339
19.19.7 Upgrading to CUPS Drivers from Adobe Drivers	339
19.19.8 Can't Use " <i>cupsaddsmb</i> " on Samba Server Which Is a PDC	340
19.19.9 Deleted Windows 200x Printer Driver Is Still Shown	340
19.19.10 Windows 200x/XP "Local Security Policies"	340
19.19.11 Administrator Cannot Install Printers for All Local Users	340
19.19.12 Print Change Notify Functions on NT-clients	340
19.19.13 Win XP-SP1	340
19.19.14 Print Options for All Users Can't Be Set on Windows 200x/XP	340
19.19.15 Most Common Blunders in Driver Settings on Windows Clients	341
19.19.16 cupsaddsmb Does Not Work with Newly Installed Printer	342
19.19.17 Permissions on /var/spool/samba/ Get Reset After Each Reboot	342
19.19.18 Print Queue Called " <i>lp</i> " Mis-handles Print Jobs	342
19.19.19 Location of Adobe PostScript Driver Files for " <i>cupsaddsmb</i> "	342
19.20 Overview of the CUPS Printing Processes	342
Chapter 20 STACKABLE VFS MODULES	344
20.1 Features and Benefits	344
20.2 Discussion	344
20.3 Included Modules	345
20.3.1 audit	345
20.3.2 extd_audit	345
20.3.2.1 Configuration of Auditing	345
20.3.3 fake_perms	346
20.3.4 recycle	346
20.3.5 netatalk	347

23.2.2.1	Registry Spoiling	378
23.2.3	MS Windows 200x/XP Professional Policies	378
23.2.3.1	Administration of Windows 200x/XP Policies	379
23.3	Managing Account/User Policies	380
23.4	Management Tools	381
23.4.1	Samba Editreg Tool-set	381
23.4.2	Windows NT4/200x	381
23.4.3	Samba PDC	381
23.5	System Startup and Logon Processing Overview	381
23.6	Common Errors	382
23.6.1	Policy Does Not Work	382
Chapter 24	DESKTOP PROFILE MANAGEMENT	383
24.1	Features and Benefits	383
24.2	Roaming Profiles	383
24.2.1	Samba Configuration for Profile Handling	384
24.2.1.1	NT4/200x User Profiles	384
24.2.1.2	Windows 9x/Me User Profiles	384
24.2.1.3	Mixed Windows 9x/Me and Windows NT4/200x User Profiles	385
24.2.1.4	Disabling Roaming Profile Support	385
24.2.2	Windows Client Profile Configuration Information	386
24.2.2.1	Windows 9x/Me Profile Setup	386
24.2.2.2	Windows NT4 Workstation	388
24.2.2.3	Windows 2000/XP Professional	388
24.2.3	Sharing Profiles between W9x/Me and NT4/200x/XP Workstations	390
24.2.4	Profile Migration from Windows NT4/200x Server to Samba	390
24.2.4.1	Windows NT4 Profile Management Tools	390
24.2.4.2	Side Bar Notes	391
24.2.4.3	moveuser.exe	391
24.2.4.4	Get SID	391
24.3	Mandatory Profiles	392
24.4	Creating and Managing Group Profiles	392
24.5	Default Profile for Windows Users	393
24.5.1	MS Windows 9x/Me	393
24.5.1.1	User Profile Handling with Windows 9x/Me	393
24.5.2	MS Windows NT4 Workstation	393
24.5.3	MS Windows 200x/XP	395
24.6	Common Errors	398
24.6.1	Configuring Roaming Profiles for a Few Users or Groups	398
24.6.2	Cannot Use Roaming Profiles	398
24.6.3	Changing the Default Profile	400
Chapter 25	PAM-BASED DISTRIBUTED AUTHENTICATION	401
25.1	Features and Benefits	401
25.2	Technical Discussion	403
25.2.1	PAM Configuration Syntax	403
25.2.1.1	Anatomy of /etc/pam.d Entries	403
25.2.2	Example System Configurations	407

25.2.2.1	PAM: Original Login Config	407
25.2.2.2	PAM: Login Using pam_smbpass	408
25.2.3	smb.conf PAM Configuration	409
25.2.4	Remote CIFS Authentication Using winbindd.so	410
25.2.5	Password Synchronization Using pam_smbpass.so	410
25.2.5.1	Password Synchronization Configuration	411
25.2.5.2	Password Migration Configuration	412
25.2.5.3	Mature Password Configuration	412
25.2.5.4	Kerberos Password Integration Configuration	413
25.3	Common Errors	413
25.3.1	pam_winbind Problem	413
25.3.2	Winbind Is Not Resolving Users and Groups	414
Chapter 26 INTEGRATING MS WINDOWS NETWORKS WITH SAMBA		415
26.1	Features and Benefits	415
26.2	Background Information	415
26.3	Name Resolution in a Pure UNIX/Linux World	416
26.3.1	/etc/hosts	416
26.3.2	/etc/resolv.conf	417
26.3.3	/etc/host.conf	417
26.3.4	/etc/nsswitch.conf	418
26.4	Name Resolution as Used within MS Windows Networking	419
26.4.1	The NetBIOS Name Cache	420
26.4.2	The LMHOSTS File	420
26.4.3	HOSTS File	422
26.4.4	DNS Lookup	422
26.4.5	WINS Lookup	422
26.5	Common Errors	423
26.5.1	Pinging Works Only in One Way	423
26.5.2	Very Slow Network Connections	423
26.5.3	Samba Server Name Change Problem	423
Chapter 27 UNICODE/CHARSETS		425
27.1	Features and Benefits	425
27.2	What Are Charsets and Unicode?	425
27.3	Samba and Charsets	426
27.4	Conversion from Old Names	426
27.5	Japanese Charsets	426
27.5.1	Basic Parameter Setting	427
27.5.2	Individual Implementations	430
27.5.3	Migration from Samba-2.2 Series	430
27.6	Common Errors	430
27.6.1	CP850.so Can't Be Found	430
Chapter 28 BACKUP TECHNIQUES		432
28.1	Features and Benefits	432
28.2	Discussion of Backup Solutions	432
28.2.1	BackupPC	432

28.2.2 Rsync	433
28.2.3 Amanda	433
28.2.4 BOBS: Browseable Online Backup System	434
Chapter 29 HIGH AVAILABILITY	435
29.1 Features and Benefits	435
29.2 Technical Discussion	435
29.2.1 The Ultimate Goal	435
29.2.2 Why Is This So Hard?	436
29.2.2.1 The Front-End Challenge	436
29.2.2.2 De-multiplexing SMB Requests	437
29.2.2.3 The Distributed File System Challenge	437
29.2.2.4 Restrictive Constraints on Distributed File Systems	437
29.2.2.5 Server Pool Communications	438
29.2.2.6 Server Pool Communications Demands	438
29.2.2.7 Required Modifications to Samba	438
29.2.3 A Simple Solution	438
29.2.4 High Availability Server Products	439
29.2.5 MS-DFS: The Poor Man's Cluster	439
29.2.6 Conclusions	439
Part IV Migration and Updating	439
Chapter 30 UPGRADING FROM SAMBA-2.X TO SAMBA-3.0.0	441
30.1 Quick Migration Guide	441
30.2 New Features in Samba-3	441
30.3 Configuration Parameter Changes	442
30.3.1 Removed Parameters	442
30.3.2 New Parameters	443
30.3.3 Modified Parameters (Changes in Behavior):	445
30.4 New Functionality	446
30.4.1 Databases	446
30.4.2 Changes in Behavior	446
30.4.3 Passdb Backends and Authentication	447
30.4.4 LDAP	447
30.4.4.1 New Schema	447
30.4.4.2 New Suffix for Searching	448
30.4.4.3 IdMap LDAP Support	448
Chapter 31 MIGRATION FROM NT4 PDC TO SAMBA-3 PDC	450
31.1 Planning and Getting Started	450
31.1.1 Objectives	450
31.1.1.1 Domain Layout	451
31.1.1.2 Server Share and Directory Layout	452
31.1.1.3 Logon Scripts	453
31.1.1.4 Profile Migration/Creation	453
31.1.1.5 User and Group Accounts	453

31.1.2	Steps in Migration Process	453
31.2	Migration Options	454
31.2.1	Planning for Success	454
31.2.2	Samba-3 Implementation Choices	455
Chapter 32	SWAT — THE SAMBA WEB ADMINISTRATION TOOL	458
32.1	Features and Benefits	458
32.2	Guidelines and Technical Tips	459
32.2.1	Validate SWAT Installation	459
32.2.1.1	Locating the swat File	459
32.2.1.2	Locating the SWAT Support Files	460
32.2.2	Enabling SWAT for Use	461
32.2.3	Securing SWAT through SSL	462
32.2.4	Enabling SWAT Internationalization Support	463
32.3	Overview and Quick Tour	464
32.3.1	The SWAT Home Page	464
32.3.2	Global Settings	464
32.3.3	Share Settings	465
32.3.4	Printers Settings	465
32.3.5	The SWAT Wizard	465
32.3.6	The Status Page	466
32.3.7	The View Page	466
32.3.8	The Password Change Page	466
Part V	Troubleshooting	465
Chapter 33	THE SAMBA CHECKLIST	467
33.1	Introduction	467
33.2	Assumptions	467
33.3	The Tests	468
Chapter 34	ANALYZING AND SOLVING SAMBA PROBLEMS	474
34.1	Diagnostics Tools	474
34.1.1	Debugging with Samba Itself	474
34.1.2	Tcpdump	475
34.1.3	Ethereal	475
34.1.4	The Windows Network Monitor	476
34.1.4.1	Installing Network Monitor on an NT Workstation	476
34.1.4.2	Installing Network Monitor on Windows 9x/Me	477
34.2	Useful URLs	477
34.3	Getting Mailing List Help	477
34.4	How to Get Off the Mailing Lists	478
Chapter 35	REPORTING BUGS	479
35.1	Introduction	479
35.2	General Information	479
35.3	Debug Levels	479
35.3.1	Debugging Specific Operations	480

35.4 Internal Errors	480
35.5 Attaching to a Running Process	481
35.6 Patches	481
Part VI Appendixes	481
Chapter 36 HOW TO COMPILE SAMBA	483
36.1 Access Samba Source Code via Subversion	483
36.1.1 Introduction	483
36.1.2 Subversion Access to samba.org	483
36.1.2.1 Access via SVNweb	483
36.1.2.2 Access via Subversion	483
36.2 Accessing the Samba Sources via rsync and ftp	484
36.3 Verifying Samba's PGP Signature	484
36.4 Building the Binaries	485
36.4.1 Compiling Samba with Active Directory Support	486
36.4.1.1 Installing the Required Packages for Debian	486
36.4.1.2 Installing the Required Packages for Red Hat Linux	486
36.4.1.3 SuSE Linux Package Requirements	487
36.5 Starting the smbd and nmbd	487
36.5.1 Starting from inetd.conf	487
36.5.2 Alternative: Starting smbd as a Daemon	489
Chapter 37 PORTABILITY	490
37.1 HPUX	490
37.2 SCO UNIX	490
37.3 DNIX	491
37.4 Red Hat Linux	492
37.5 AIX	492
37.5.1 Sequential Read Ahead	492
37.6 Solaris	493
37.6.1 Locking Improvements	493
37.6.2 Winbind on Solaris 9	493
Chapter 38 SAMBA AND OTHER CIFS CLIENTS	494
38.1 Macintosh Clients	494
38.2 OS2 Client	494
38.2.1 Configuring OS/2 Warp Connect or OS/2 Warp 4	494
38.2.2 Configuring Other Versions of OS/2	495
38.2.3 Printer Driver Download for OS/2 Clients	495
38.3 Windows for Workgroups	496
38.3.1 Latest TCP/IP Stack from Microsoft	496
38.3.2 Delete .pwl Files After Password Change	496
38.3.3 Configuring Windows for Workgroups Password Handling	496
38.3.4 Password Case Sensitivity	496
38.3.5 Use TCP/IP as Default Protocol	497
38.3.6 Speed Improvement	497

38.4 Windows 95/98	497
38.4.1 Speed Improvement	497
38.5 Windows 2000 Service Pack 2	497
38.6 Windows NT 3.1	498
Chapter 39 SAMBA PERFORMANCE TUNING	499
39.1 Comparisons	499
39.2 Socket Options	499
39.3 Read Size	500
39.4 Max Xmit	500
39.5 Log Level	500
39.6 Read Raw	501
39.7 Write Raw	501
39.8 Slow Logins	501
39.9 Client Tuning	501
39.10 Samba Performance Problem Due to Changing Linux Kernel	501
39.11 Corrupt tdb Files	502
39.12 Samba Performance is Very Slow	502
Chapter 40 DNS AND DHCP CONFIGURATION GUIDE	503
40.1 Features and Benefits	503
40.2 Example Configuration	503
40.2.1 Dynamic DNS	504
40.2.2 DHCP Server	507
Chapter A GNU GENERAL PUBLIC LICENSE	509
A.1 Preamble	509
A.2 TERMS AND CONDITIONS FOR COPYING, DISTRIBUTION AND MOD- IFICATION	510
A.2.1 Section 0	510
A.2.2 Section 1	510
A.2.3 Section 2	510
A.2.4 Section 3	511
A.2.5 Section 4	512
A.2.6 Section 5	512
A.2.7 Section 6	512
A.2.8 Section 7	513
A.2.9 Section 8	513
A.2.10 Section 9	513
A.2.11 Section 10	514
A.2.12 NO WARRANTY Section 11	514
A.2.13 Section 12	514
A.3 How to Apply These Terms to Your New Programs	514
GLOSSARY	516
Glossary	519
SUBJECT INDEX	521

Index

527

List of Figures

4 Domain Control	
4.1	39
8 MS Windows Network Configuration Guide	
8.1 Network Bridge Configuration.	84
8.2 Internet Protocol (TCP/IP) Properties.	85
8.3 Advanced Network Settings	86
8.4 DNS Configuration.	87
8.5 WINS Configuration	88
8.6 Local Area Connection Properties.	89
8.7 Internet Protocol (TCP/IP) Properties.	90
8.8 Advanced Network Settings.	91
8.9 DNS Configuration.	92
8.10 WINS Configuration.	93
8.11 The Windows Me Network Configuration Panel.	93
8.12 IP Address.	94
8.13 DNS Configuration.	94
8.14 WINS Configuration.	95
8.15 The General Panel.	95
8.16 The Computer Name Panel.	96
8.17 The Computer Name Changes Panel.	96
8.18 The Computer Name Changes Panel Domain MIDEARTH.	97
8.19 Computer Name Changes User name and Password Panel.	97
8.20 The Network Panel.	98
8.21 Client for Microsoft Networks Properties Panel.	98
8.22 Identification Panel.	99
8.23 Identification Panel.	99
9 Network Browsing	
9.1 Cross-Subnet Browsing Example.	120
10 Account Information Databases	
10.1 IDMAP: Resolution of SIDs to UIDs.	128
10.2 IDMAP: Resolution of UIDs to SIDs.	129
11 Group Mapping — MS Windows and UNIX	
11.1	151
11.2	151

11.3	152
13 File, Directory and Share Access Controls	
13.1 Overview of UNIX permissions field.	175
16 Interdomain Trust Relationships	
16.1 Trusts overview.	211
19 CUPS Printing Support	
19.1 Windows printing to a local printer.	273
19.2 Printing to a PostScript printer.	275
19.3 Ghostscript as a RIP for non-postscript printers.	275
19.4 Pre-filtering in CUPS to form PostScript.	282
19.5 Adding device-specific print options.	282
19.6 PostScript to intermediate raster format.	283
19.7 CUPS-raster production using Ghostscript.	283
19.8 Image format to CUPS-raster format conversion.	284
19.9 Raster to printer-specific formats.	285
19.10 cupsomatic/foomatic Processing versus Native CUPS.	291
19.11 PDF to socket chain.	292
19.12 PDF to USB chain.	293
19.13 Print driver execution on the client.	295
19.14 Print driver execution on the server.	296
19.15 Printing via CUPS/Samba server.	297
19.16 cupsaddsmb flowchart.	311
19.17 Filtering chain 1.	337
19.18 Filtering chain with cupsomatic	338
19.19 CUPS printing overview.	343
21 Winbind: Use of Domain Accounts	
21.1 Winbind Idmap	353
34 Analyzing and Solving Samba Problems	
34.1 Starting a capture.	475
34.2 Main ethereal data window.	476

List of Tables

5 Backup Domain Control	
5.1 Domain Backend Account Distribution Options	56
6 Domain Membership	
6.1 Assumptions	70
9 Network Browsing	
9.1 Browse Subnet Example 1	120
9.2 Browse Subnet Example 2	121
9.3 Browse Subnet Example 3	121
9.4 Browse Subnet Example 4	122
10 Account Information Databases	
10.1 Attributes in the sambaSamAccount objectclass (LDAP) — Part A	147
10.2 Attributes in the sambaSamAccount objectclass (LDAP) — Part B	148
10.3 Possible <i>ldap passwd sync</i> values	148
10.4 Basic smb.conf options for MySQL passdb backend	148
10.5 MySQL field names for MySQL passdb backend	149
11 Group Mapping — MS Windows and UNIX	
11.1 Well-Known User Default RIDs	154
13 File, Directory and Share Access Controls	
13.1 Managing Directories with UNIX and Windows	174
13.2 User and Group Based Controls	177
13.3 File and Directory Permission Based Controls	178
13.4 Other Controls	179
18 Classical Printing Support	
18.1 Default Printing Settings	231
19 CUPS Printing Support	
19.1 PPDs shipped with CUPS	290
20 Stackable VFS modules	

20.1	Extended Auditing Log Information	346
24	Desktop Profile Management	
24.1	User Shell Folder Registry Keys Default Values	395
24.2	Defaults of Profile Settings Registry Keys	395
24.3	Defaults of Default User Profile Paths Registry Keys	397
25	PAM-Based Distributed Authentication	
25.1	Options recognized by pam_smbpass	411
26	Integrating MS Windows Networks with Samba	
26.1	Unique NetBIOS Names	419
26.2	Group Names	419
27	Unicode/Charsets	
27.1	Japanese Character Sets in Samba-2.2 and Samba-3	431
30	Upgrading from Samba-2.x to Samba-3.0.0	
30.1	TDB File Descriptions	446
31	Migration from NT4 PDC to Samba-3 PDC	
31.1	The Three Major Site Types	454
31.2	Nature of the Conversion Choices	455
35	Reporting Bugs	
35.1	Debuggable Functions	481

PREFACE AND INTRODUCTION

[chapterinfo] John H. Terpstra [pubdate] June 29, 2003 [/pubdate] [/chapterinfo]

“A man’s gift makes room for him before great men. Gifts are like hooks that can catch hold of the mind taking it beyond the reach of forces that otherwise might constrain it.” — Anon.

This is a book about Samba. It is a tool, a derived work of the labors of many and of the diligence and goodwill of more than a few. This book contains material that has been contributed in a persistent belief that each of us can add value to our neighbors as well as to those who will follow us.

This book is designed to meet the needs of the Microsoft network administrator. UNIX administrators will benefit from this book also, though they may complain that it is hard to find the information they think they need. So if you are a Microsoft certified specialist, this book should meet your needs rather well. If you are a UNIX or Linux administrator, there is no need to feel badly — you should have no difficulty finding answers to your current concerns also.

What Is Samba?

Samba is a big, complex project. The Samba project is ambitious and exciting. The team behind Samba is a group of some thirty individuals who are spread the world over and come from an interesting range of backgrounds. This team includes scientists, engineers, programmers, business people, and students.

Team members were drawn into active participation through the desire to help deliver an exciting level of transparent interoperability between Microsoft Windows and the non-Microsoft information technology world.

The slogan that unites the efforts behind the Samba project says: *Samba, Opening Windows to a Wider World!* The goal behind the project is one of removing barriers to interoperability.

Samba provides file and print services for Microsoft Windows clients. These services may be hosted off any TCP/IP-enabled platform. The original deployment platforms were UNIX and Linux, though today it is in common use across a broad variety of systems.

The Samba project includes not only an impressive feature set in file and print serving capabilities, but has been extended to include client functionality, utilities to ease migration to Samba, tools to aid interoperability with Microsoft Windows, and administration tools.

The real people behind Samba are users like you. You have inspired the developers (the Samba Team) to do more than any of them imagined could or should be done. User feedback drives Samba development. Samba-3 in particular incorporates a huge amount of work done as a result of user requests, suggestions and direct code contributions.

Why This Book?

There is admittedly a large number of Samba books on the market today and each book has its place. Despite the apparent plethora of books, Samba as a project continues to receive much criticism for failing to provide sufficient documentation. Samba is also criticized for being too complex and too difficult to configure. In many ways this is evidence of the success of Samba as there would be no complaints if it was not successful.

The Samba Team members work predominantly with UNIX and Linux, so it is hardly surprising that existing Samba documentation should reflect that orientation. The original HOWTO text documents were intended to provide some tips, a few golden nuggets, and if they helped anyone then that was just wonderful. But the HOWTO documents lacked structure and context. They were isolated snapshots of information that were written to pass information on to someone else who might benefit. They reflected a need to transmit more information that could be conveniently put into manual pages.

The original HOWTO documents were written by different authors. Most HOWTO documents are the result of feedback and contributions from numerous authors. In this book we took care to preserve as much original content as possible. As you read this book you will note that chapters were written by multiple authors, each of whom has his own style. This demonstrates the nature of the Open Source software development process.

Out of the original HOWTO documents sprang a collection of unofficial HOWTO documents that are spread over the Internet. It is sincerely intended that this work will *not* replace the valuable unofficial HOWTO work that continues to flourish. If you are involved in unofficial HOWTO production then please continue your work!

Those of you who have dedicated your labors to the production of unofficial HOWTOs, to Web page information regarding Samba, or to answering questions on the mailing lists or elsewhere, may be aware that this is a labor of love. We would like to know about your contribution and willingly receive the precious pearls of wisdom you have collected. Please email your contribution to John H. Terpstra (jht@samba.org) <<mailto:jht@samba.org>>. As a service to other users we will gladly adopt material that is technically accurate.

Existing Samba books are largely addressed to the UNIX administrator. From the perspective of this target group the existing books serve an adequate purpose, with one exception — now that Samba-3 is out they need to be updated!

This book, the *Official Samba-3 HOWTO and Reference Guide*, includes the Samba-HOWTO-Collection.pdf that ships with Samba. These documents have been written with a new design intent and purpose.

Over the past two years many Microsoft network administrators have adopted Samba and have become interested in its deployment. Their information needs are very different from that of the UNIX administrator. This book has been arranged and the information presented from the perspective of someone with previous Microsoft Windows network administrative training and experience.

Book Structure and Layout

This book is presented in six parts:

General Installation Designed to help you get Samba-3 running quickly. The Fast Start chapter is a direct response to requests from Microsoft network administrators for some sample configurations that *just work*.

Server Configuration Basics The purpose of this section is to aid the transition from existing Microsoft Windows network knowledge to Samba terminology and norms. The chapters in this part each cover the installation of one type of Samba server.

Advanced Configuration The mechanics of network browsing have long been the Achilles heel of all Microsoft Windows users. Samba-3 introduces new user and machine account management facilities, a new way to map UNIX groups and Windows groups, Interdomain trusts, new loadable file system drivers (VFS), and more. New with this document is expanded printing documentation, as well as a wealth of information regarding desktop and user policy handling, use of desktop profiles, and techniques for enhanced network integration. This section makes up the core of the book. Read and enjoy.

Migration and Updating A much requested addition to the book is information on how to migrate from Microsoft Windows NT4 to Samba-3, as well as an overview of what the issues are when moving from Samba-2.x to Samba-3.

Troubleshooting This short section should help you when all else fails.

Appendix Here you will find a collection of things that are either too peripheral for most users, or are a little left of field to be included in the main body of information.

Welcome to Samba-3 and the first published document to help you and your users to enjoy a whole new world of interoperability between Microsoft Windows and the rest of the world.

Part I

General Installation

PREPARING SAMBA FOR CONFIGURATION

This section of the Samba-HOWTO-Collection contains general info on how to install Samba and how to configure the parts of Samba you will most likely need. PLEASE read this.

HOW TO INSTALL AND TEST SAMBA

1.1 Obtaining and Installing Samba

Binary packages of Samba are included in almost any Linux or UNIX distribution. There are also some packages available at the Samba home-page <<http://samba.org/>>. Refer to the manual of your operating system for details on installing packages for your specific operating system.

If you need to compile Samba from source, check How to compile Samba chapter.

1.2 Configuring Samba (`smb.conf`)

Samba's configuration is stored in the `smb.conf` file, which usually resides in `/etc/samba/smb.conf` or `/usr/local/samba/lib/smb.conf`. You can either edit this file yourself or do it using one of the many graphical tools that are available, such as the Web-based interface SWAT, that is included with Samba.

1.2.1 Configuration file syntax

The `smb.conf` file uses the same syntax as the various old `.ini` files in Windows 3.1: Each file consists of various sections, which are started by putting the section name between brackets (`[]`) on a new line. Each contains zero or more key/value-pairs separated by an equality sign (`=`). The file is just a plain-text file, so you can open and edit it with your favorite editing tool.

Each section in the `smb.conf` file represents a share on the Samba server. The section "*global*" is special, since it contains settings that apply to the whole Samba server and not to one share in particular.

Following example contains a very minimal `smb.conf`.

Example 1.2.1. A minimal smb.conf

```
[global]
    workgroup = WKG
    netbios name = MYNAME

[share1]
    path = /tmp

[share2]
    path = /my_shared_folder
    comment = Some random files
```

1.2.2 Starting Samba

Samba essentially consists of two or three daemons. A daemon is a UNIX application that runs in the background and provides services. An example of a service is the Apache Web server for which the daemon is called **httpd**. In the case of Samba there are three daemons, two of which are needed as a minimum.

The Samba server is made up of the following daemons:

nmbd This daemon handles all name registration and resolution requests. It is the primary vehicle involved in network browsing. It handles all UDP based protocols. The **nmbd** daemon should be the first command started as part of the Samba start-up process.

smbd This daemon handles all TCP/IP based connection services for file and print based operations. It also manages local authentication. It should be started immediately following the start-up of **nmbd**.

winbindd This daemon should be started when Samba is a member of a Windows NT4 or ADS Domain. It is also needed when Samba has trust relationships with another Domain. The **winbindd** daemon will check the **smb.conf** file for the presence of the *idmap uid* and *idmap gid* parameters. If they are not found **winbindd** will bail-out and refuse to start.

When Samba has been packaged by an operating system vendor the start-up process is typically a custom feature of its integration into the platform as a whole. Please refer to your operating system platform administration manuals for specific information pertaining to correct management of Samba start-up.

1.2.3 Example Configuration

There are sample configuration files in the examples subdirectory in the distribution. It is suggested you read them carefully so you can see how the options go together in prac-

tice. See the man page for all the options. It might be worthwhile to start out with the `smb.conf.default` configuration file and adapt it to your needs. It contains plenty of comments.

The simplest useful configuration file would contain something like shown in the next example.

Example 1.2.2. Another simple `smb.conf` File

```
[global]
    workgroup = MIDEARTH

[homes]
    guest ok = no
    read only = no
```

This will allow connections by anyone with an account on the server, using either their login name or `homes` as the service name. (Note: The workgroup that Samba should appear in must also be set. The default workgroup name is `WORKGROUP`.)

Make sure you put the `smb.conf` file in the correct place.

For more information about security settings for the `[homes]` share please refer to Securing Samba chapter.

1.2.3.1 Test Your Config File with `testparm`

It's important to validate the contents of the `smb.conf` file using the `testparm` program. If `testparm` runs correctly, it will list the loaded services. If not, it will give an error message. Make sure it runs correctly and that the services look reasonable before proceeding. Enter the command:

```
root# testparm /etc/samba/smb.conf
```

`Testparm` will parse your configuration file and report any unknown parameters or incorrect syntax.

Always run `testparm` again whenever the `smb.conf` file is changed!

1.2.4 SWAT

SWAT is a Web-based interface that can be used to facilitate the configuration of Samba. SWAT might not be available in the Samba package that shipped with your platform, but in a separate package. Please read the SWAT man page on compiling, installing and configuring SWAT from source.

To launch SWAT, just run your favorite Web browser and point it to `<http://localhost:901/>`. Replace *localhost* with the name of the computer on which Samba is running if that is a different computer than your browser.

SWAT can be used from a browser on any IP-connected machine, but be aware that connecting from a remote machine leaves your connection open to password sniffing as passwords will be sent over the wire in the clear.

More information about SWAT can be found in corresponding chapter.

1.3 List Shares Available on the Server

To list shares that are available from the configured Samba server execute the following command:

```
$ smbclient -L yourhostname
```

You should see a list of shares available on your server. If you do not, then something is incorrectly configured. This method can also be used to see what shares are available on other SMB servers, such as Windows 2000.

If you choose user-level security you may find that Samba requests a password before it will list the shares. See the **smbclient** man page for details. You can force it to list the shares without a password by adding the option `-N` to the command line.

1.4 Connect with a UNIX Client

Enter the following command:

```
$ smbclient //yourhostname/aservice
```

Typically *yourhostname* is the name of the host on which `smbd` has been installed. The *aservice* is any service that has been defined in the `smb.conf` file. Try your user name if you just have a `[homes]` section in the `smb.conf` file.

Example: If the UNIX host is called *bambi* and a valid login name is *fred*, you would type:

```
$ smbclient //bambi/fred
```

1.5 Connect from a Remote SMB Client

Now that Samba is working correctly locally, you can try to access it from other clients. Within a few minutes, the Samba host should be listed in the Network Neighborhood on all Windows clients of its subnet. Try browsing the server from another client or 'mounting' it.

Mounting disks from a DOS, Windows or OS/2 client can be done by running a command such as:

```
C:\> net use d: \\servername\service
```

Try printing, e.g.

```
C:\> net use lpt1: \\servername\spoolservice
```

```
C:\> print filename
```

1.6 What If Things Don't Work?

You might want to read The Samba Checklist. If you are still stuck, refer to Analyzing and Solving Samba Problems chapter. Samba has been successfully installed at thousands of sites worldwide. It is unlikely that your particular problem is unique, so it might be productive to perform an Internet search to see if someone else has encountered your problem and has found a way to overcome it.

1.7 Common Errors

The following questions and issues are raised repeatedly on the Samba mailing list.

1.7.1 Large Number of `smbd` Processes

Samba consists of three core programs: `nmbd`, `smbd`, and `winbindd`. `nmbd` is the name server message daemon, `smbd` is the server message daemon, and `winbindd` is the daemon that handles communication with Domain Controllers.

If Samba is *not* running as a WINS server, then there will be one single instance of `nmbd` running on your system. If it is running as a WINS server then there will be two instances — one to handle the WINS requests.

`smbd` handles all connection requests. It spawns a new process for each client connection made. That is why you may see so many of them, one per client connection.

`winbindd` will run as one or two daemons, depending on whether or not it is being run in *split mode* (in which case there will be two instances).

1.7.2 Error Message: `open_oplock_ipc`

An error message is observed in the log files when `smbd` is started: “*open_oplock_ipc: Failed to get local UDP socket for address 100007f. Error was Cannot assign requested.*”

Your loopback device isn't working correctly. Make sure it is configured correctly. The loopback device is an internal (virtual) network device with the IP address *127.0.0.1*. Read your OS documentation for details on how to configure the loopback on your system.

1.7.3 “*The network name cannot be found*”

This error can be caused by one of these mis-configurations:

- You specified an non-existing path for the share in `smb.conf`.
- The user you are trying to access the share with does not have sufficient permissions to access the path for the share. Both read (r) and access (x) should be possible.
- The share you are trying to access does not exist.

FAST START: CURE FOR IMPATIENCE

When we first asked for suggestions for inclusion in the Samba HOWTO documentation, someone wrote asking for example configurations — and lots of them. That is remarkably difficult to do, without losing a lot of value that can be derived from presenting many extracts from working systems. That is what the rest of this document does. It does so with extensive descriptions of the configuration possibilities within the context of the chapter that covers it. We hope that this chapter is the medicine that has been requested.

2.1 Features and Benefits

Samba needs very little configuration to create a basic working system. In this chapter we progress from the simple to the complex, for each providing all steps and configuration file changes needed to make each work. Please note that a comprehensively configured system will likely employ additional smart features. The additional features are covered in the remainder of this document.

The examples used here have been obtained from a number of people who made requests for example configurations. All identities have been obscured to protect the guilty and any resemblance to unreal non-existent sites is deliberate.

2.2 Description of Example Sites

In the first set of configuration examples we consider the case of exceptionally simple system requirements. There is a real temptation to make something that should require little effort much too complex.

Section 2.3.1.1 documents the type of server that might be sufficient to serve CD-ROM images, or reference document files for network client use. This configuration is also discussed in Chapter 7, “Stand-alone Servers”, Section 7.3.1. The purpose for this configuration is to provide a shared volume that is read-only that anyone, even guests, can access.

The second example shows a minimal configuration for a print server that anyone can print to as long as they have the correct printer drivers installed on their computer. This is a

mirror of the system described in Chapter 7, “Stand-alone Servers”, Section 7.3.2.

The next example is of a secure office file and print server that will be accessible only to users who have an account on the system. This server is meant to closely resemble a Workgroup file and print server, but has to be more secure than an anonymous access machine. This type of system will typically suit the needs of a small office. The server does not provide network logon facilities, offers no Domain Control, instead it is just a network attached storage (NAS) device and a print server.

Finally, we start looking at more complex systems that will either integrate into existing Microsoft Windows networks, or replace them entirely. The examples provided cover domain member servers as well as Samba Domain Control (PDC/BDC) and finally describes in detail a large distributed network with branch offices in remote locations.

2.3 Worked Examples

The configuration examples are designed to cover everything necessary to get Samba running. They do not cover basic operating system platform configuration, which is clearly beyond the scope of this text.

It is also assumed that Samba has been correctly installed, either by way of installation of the packages that are provided by the operating system vendor, or through other means.

2.3.1 Stand-alone Server

A Stand-alone Server implies no more than the fact that it is not a Domain Controller and it does not participate in Domain Control. It can be a simple workgroup-like server, or it may be a complex server that is a member of a domain security context.

2.3.1.1 Anonymous Read-Only Document Server

The purpose of this type of server is to make available to any user any documents or files that are placed on the shared resource. The shared resource could be a CD-ROM drive, a CD-ROM image, or a file storage area.

As the examples are developed, every attempt is made to progress the system toward greater capability, just as one might expect would happen in a real business office as that office grows in size and its needs change.

The configuration file is:

- The file system share point will be `/export`.
- All files will be owned by a user called Jack Baumbach. Jack’s login name will be *jackb*. His password will be *m0r3pa1n* — of course, that’s just the example we are using; do not use this in a production environment because all readers of this document will know it.

Installation Procedure Read-Only Server

1. Add user to system (with creation of the users’ home directory):

Example 2.3.1. Anonymous Read-Only Server Configuration

```
# Global parameters
```

```
[global]
    workgroup = MIDEARTH
    netbios name = HOBBIT
    security = share
```

```
[data]
    comment = Data
    path = /export
    read only = Yes
    guest ok = Yes
```

```
root# useradd -c "Jack Baumbach" -m -g users -p m0r3pa1n jackb
```

2. Create directory, and set permissions and ownership:

```
root# mkdir /export
root# chmod u+rwx,g+rx,o+rx /export
root# chown jackb.users /export
```

3. Copy the files that should be shared to the `/export` directory.
4. Install the Samba configuration file (`/etc/samba/smb.conf`) as shown.
5. Test the configuration file:

```
root# testparm
```

Note any error messages that might be produced. Do not proceed until you obtain error-free output. An example of the output with the following file will list the file.

```
Load smb config files from /etc/samba/smb.conf
Processing section "[data]"
Loaded services file OK.
Server role: ROLE_STANDALONE
Press enter to see a dump of your service definitions
[Press enter]
```

```
# Global parameters
[global]
    workgroup = MIDEARTH
```

```
netbios name = HOBBIT
security = share

[data]
comment = Data
path = /export
read only = Yes
guest only = Yes
```

6. Start Samba using the method applicable to your operating system platform.
7. Configure your Microsoft Windows client for workgroup *MIDEARTH*, set the machine name to *ROBBINS*, reboot, wait a few (2 - 5) minutes, then open Windows Explorer and visit the network neighborhood. The machine *HOBBIT* should be visible. When you click this machine icon, it should open up to reveal the *data* share. After clicking the share it, should open up to reveal the files previously placed in the */export* directory.

The information above (following # Global parameters) provides the complete contents of the */etc/samba/smb.conf* file.

2.3.1.2 Anonymous Read-Write Document Server

We should view this configuration as a progression from the previous example. The difference is that shared access is now forced to the user identity of *jackb* and to the primary group *jackb* belongs to. One other refinement we can make is to add the user *jackb* to the *smbpasswd* file. To do this execute:

```
root# smbpasswd -a jackb
New SMB password: m0r3pa1n
Retype new SMB password: m0r3pa1n
Added user jackb.
```

Addition of this user to the *smbpasswd* file allows all files to be displayed in the Explorer Properties boxes as belonging to *jackb* instead of to *User Unknown*.

The complete, modified *smb.conf* file is as shown in Example 2.3.2.

2.3.1.3 Anonymous Print Server

An anonymous print server serves two purposes:

- It allows printing to all printers from a single location.
- It reduces network traffic congestion due to many users trying to access a limited number of printers.

In the simplest of anonymous print servers, it is common to require the installation of the correct printer drivers on the Windows workstation. In this case the print server will be

Example 2.3.2. Modified Anonymous Read-Write smb.conf

```
# Global parameters

[global]
    workgroup = MIDEARTH
    netbios name = HOBBIT
    security = SHARE

[data]
    comment = Data
    path = /export
    force user = jackb
    force group = users
    read only = No
    guest ok = Yes
```

designed to just pass print jobs through to the spooler, and the spooler should be configured to do raw pass-through to the printer. In other words, the print spooler should not filter or process the data stream being passed to the printer.

In this configuration it is undesirable to present the Add Printer Wizard and we do not want to have automatic driver download, so we will disable it in the following configuration. Example 2.3.3 is the resulting smb.conf file.

Example 2.3.3. Anonymous Print Server smb.conf

```
# Global parameters

[global]
    workgroup = MIDEARTH
    netbios name = LUTHIEN
    security = share
    printcap name = cups
    disable spoolss = Yes
    show add printer wizard = No
    printing = cups

[printers]
    comment = All Printers
    path = /var/spool/samba
    guest ok = Yes
    printable = Yes
    use client driver = Yes
    browseable = No
```

The above configuration is not ideal. It uses no smart features, and it deliberately presents a less than elegant solution. But it is basic, and it does print.

NOTE



Windows users will need to install a local printer and then change the print to device after installation of the drivers. The print to device can then be set to the network printer on this machine.

Make sure that the directory `/var/spool/samba` is capable of being used as intended. The following steps must be taken to achieve this:

- The directory must be owned by the superuser (root) user and group:

```
root# chown root.root /var/spool/samba
```

- Directory permissions should be set for public read-write with the sticky-bit set as shown:

```
root# chmod a+rw TX /var/spool/samba
```

NOTE



On CUPS enabled systems there is a facility to pass raw data directly to the printer without intermediate processing via CUPS print filters. Where use of this mode of operation is desired it is necessary to configure a raw printing device. It is also necessary to enable the raw mime handler in the `/etc/mime.conv` and `/etc/mime.types` files. Refer to Section 19.3.4.

2.3.1.4 Secure Read-Write File and Print Server

We progress now from simple systems to a server that is slightly more complex.

Our new server will require a public data storage area in which only authenticated users (i.e., those with a local account) can store files, as well as a home directory. There will be one printer that should be available for everyone to use.

In this hypothetical environment (no espionage was conducted to obtain this data), the site is demanding a simple environment that is *secure enough* but not too difficult to use.

Site users will be: Jack Baumbach, Mary Orville and Amed Sehkah. Each will have a password (not shown in further examples). Mary will be the printer administrator and will own all files in the public share.

This configuration will be based on *User Level Security* that is the default, and for which the default is to store Microsoft Windows-compatible encrypted passwords in a file called `/etc/samba/smbpasswd`. The default `smb.conf` entry that makes this happen is: `passwd backend = smbpasswd, guest`. Since this is the default it is not necessary to enter it into the configuration file. Note that `guest backend` is added to the list of active `passwd` backends not matter was it specified directly in Samba configuration file or not. Installing the Secure Office Server

1. Add all users to the Operating System:

```
root# useradd -c "Jack Baumbach" -m -g users -p m0r3pa1n jackb
root# useradd -c "Mary Orville" -m -g users -p secret maryo
root# useradd -c "Amed Sehkah" -m -g users -p secret ameds
```

2. Configure the Samba `smb.conf` file as shown in Example 2.3.4.
3. Initialize the Microsoft Windows password database with the new users:

```
root# smbpasswd -a root
New SMB password: bigsecret
Reenter smb password: bigsecret
Added user root.
```

```
root# smbpasswd -a jackb
New SMB password: m0r3pa1n
Retype new SMB password: m0r3pa1n
Added user jackb.
```

```
root# smbpasswd -a maryo
New SMB password: secret
Reenter smb password: secret
Added user maryo.
```

```
root# smbpasswd -a ameds
New SMB password: mysecret
Reenter smb password: mysecret
Added user ameds.
```

4. Install printer using the CUPS Web interface. Make certain that all printers that will be shared with Microsoft Windows clients are installed as raw printing devices.
5. Start Samba using the operating system administrative interface. Alternately, this can be done manually by running:

Example 2.3.4. Secure Office Server smb.conf

```
# Global parameters

[global]
    workgroup = MIDEARTH
    netbios name = OLORIN
    printcap name = cups
    disable spoolss = Yes
    show add printer wizard = No
    printing = cups

[homes]
    comment = Home Directories
    valid users = %S
    read only = No
    browseable = No

[public]
    comment = Data
    path = /export
    force user = maryo
    force group = users
    guest ok = Yes
    read only = No

[printers]
    comment = All Printers
    path = /var/spool/samba
    printer admin = root, maryo
    create mask = 0600
    guest ok = Yes
    printable = Yes
    use client driver = Yes
    browseable = No
```

```
root# nmbd; smbd;
```

6. Configure the /export directory:

```
root# mkdir /export
root# chown maryo.users /export
root# chmod u=rwx,g=rwx,o-rwx /export
```

7. Check that Samba is running correctly:

```

root# smbclient -L localhost -U%
Domain=[MIDEARTH] OS=[UNIX] Server=[Samba-3.0.0]

Sharename      Type           Comment
-----
public         Disk          Data
IPC$           IPC           IPC Service (Samba-3.0.0)
ADMIN$         IPC           IPC Service (Samba-3.0.0)
hplj4          Printer       hplj4

Server          Comment
-----
OLORIN          Samba-3.0.0

Workgroup       Master
-----
MIDEARTH       OLORIN

```

8. Connect to OLORIN as maryo:

```

root# smbclient //olorin/maryo -Umaryo%secret
OS=[UNIX] Server=[Samba-3.0.0]
smb: \> dir
.                D           0   Sat Jun 21 10:58:16 2003
..               D           0   Sat Jun 21 10:54:32 2003
Documents        D           0   Fri Apr 25 13:23:58 2003
DOCWORK          D           0   Sat Jun 14 15:40:34 2003
OpenOffice.org   D           0   Fri Apr 25 13:55:16 2003
.bashrc          H           1286 Fri Apr 25 13:23:58 2003
.netscape6       DH          0   Fri Apr 25 13:55:13 2003
.mozilla         DH          0   Wed Mar 5 11:50:50 2003
.kermrc          H           164  Fri Apr 25 13:23:58 2003
.acrobat         DH          0   Fri Apr 25 15:41:02 2003

55817 blocks of size 524288. 34725 blocks available
smb: \> q

```

By now you should be getting the hang of configuration basics. Clearly, it is time to explore slightly more complex examples. For the remainder of this chapter we will abbreviate instructions since there are previous examples.

2.3.2 Domain Member Server

In this instance we will consider the simplest server configuration we can get away with to make an accounting department happy. Let's be warned, the users are accountants and they

do have some nasty demands. There is a budget for only one server for this department.

The network is managed by an internal Information Services Group (ISG), to which we belong. Internal politics are typical of a medium-sized organization; Human Resources is of the opinion that they run the ISG because they are always adding and disabling users. Also, departmental managers have to fight tooth and nail to gain basic network resources access for their staff. Accounting is different though, they get exactly what they want. So this should set the scene.

We will use the users from the last example. The accounting department has a general printer that all departmental users may. There is also a check printer that may be used only by the person who has authority to print checks. The Chief Financial Officer (CFO) wants that printer to be completely restricted and for it to be located in the private storage area in her office. It therefore must be a network printer.

Accounting department uses an accounting application called *SpytFull* that must be run from a central application server. The software is licensed to run only off one server, there are no workstation components, and it is run off a mapped share. The data store is in a UNIX-based SQL backend. The UNIX gurus look after that, so is not our problem.

The accounting department manager (maryo) wants a general filing system as well as a separate file storage area for form letters (nastygrams). The form letter area should be read-only to all accounting staff except the manager. The general filing system has to have a structured layout with a general area for all staff to store general documents, as well as a separate file area for each member of her team that is private to that person, but she wants full access to all areas. Users must have a private home share for personal work-related files and for materials not related to departmental operations.

2.3.2.1 Example Configuration

The server *valinor* will be a member server of the company domain. Accounting will have only a local server. User accounts will be on the Domain Controllers as will desktop profiles and all network policy files.

1. Do not add users to the UNIX/Linux server; all of this will run off the central domain.
2. Configure `smb.conf` according to Example 2.3.5 and Example 2.3.6.
3. Join the domain. Note: Do not start Samba until this step has been completed!

```
root# net rpc join -Uroot%'bigsecret'  
Joined domain MIDEARTH.
```

4. Make absolutely certain that you disable (shut down) the `nscd` daemon on any system on which `winbind` is configured to run.
5. Start Samba following the normal method for your operating system platform. If you wish to this manually execute as root:

Example 2.3.5. Member server smb.conf (globals)

Global parameters

```
[global]
    workgroup = MIDEARTH
    netbios name = VALINOR
    security = DOMAIN
    printcap name = cups
    disable spoolss = Yes
    show add printer wizard = No
    idmap uid = 15000-20000
    idmap gid = 15000-20000
    winbind use default domain = Yes
    use sendfile = Yes
    printing = cups
```

```
root# nmbd; smb; winbindd;
```

6. Configure the name service switch control file on your system to resolve user and group names via winbind. Edit the following lines in `/etc/nsswitch.conf`:

```
passwd: files winbind
group: files winbind
hosts: files dns winbind
```

7. Set the password for **wbinfo** to use:

```
root# wbinfo --set-auth-user=root%'bigsecret'
```

8. Validate that domain user and group credentials can be correctly resolved by executing:

```
root# wbinfo -u
MIDEARTH\maryo
MIDEARTH\jackb
MIDEARTH\ameds
...
MIDEARTH\root
```

```
root# wbinfo -g
MIDEARTH\Domain Users
MIDEARTH\Domain Admins
MIDEARTH\Domain Guests
```

Example 2.3.6. Member server smb.conf (shares and services)

```
[homes]
    comment = Home Directories
    valid users = %S
    read only = No
    browseable = No

[spytfull]
    comment = Accounting Application Only
    path = /export/spytfull
    valid users = @Accounts
    admin users = maryo
    read only = Yes

[public]
    comment = Data
    path = /export/public
    read only = No

[printers]
    comment = All Printers
    path = /var/spool/samba
    printer admin = root, maryo
    create mask = 0600
    guest ok = Yes
    printable = Yes
    use client driver = Yes
    browseable = No
```

```
...
MIDEARTH\Accounts
```

9. Check that **winbind** is working. The following demonstrates correct username resolution via the **getent** system utility:

```
root# getent passwd maryo
maryo:x:15000:15003:Mary Orville:/home/MIDEARTH/maryo:/bin/false
```

10. A final test that we have this under control might be reassuring:

```
root# touch /export/a_file
root# chown maryo /export/a_file
root# ls -al /export/a_file
```

```
...
-rw-r--r--  1 maryo  users      11234 Jun 21 15:32 a_file
...

root# rm /export/a_file
```

11. Configuration is now mostly complete, so this is an opportune time to configure the directory structure for this site:

```
root# mkdir -p /export/{sptyfull,public}
root# chmod ug=rwxS,o=x /export/{sptyfull,public}
root# chown maryo.Accounts /export/{sptyfull,public}
```

2.3.3 Domain Controller

For the remainder of this chapter the focus is on the configuration of Domain Control. The examples that follow are for two implementation strategies. Remember, our objective is to create a simple but working solution. The remainder of this book should help to highlight opportunity for greater functionality and the complexity that goes with it.

A Domain Controller configuration can be achieved with a simple configuration using the new `tdbsam` password backend. This type of configuration is good for small offices, but has limited scalability (cannot be replicated) and performance can be expected to fall as the size and complexity of the domain increases.

The use of `tdbsam` is best limited to sites that do not need more than a primary Domain Controller (PDC). As the size of a domain grows the need for additional Domain Controllers becomes apparent. Do not attempt to under-resource a Microsoft Windows network environment; Domain Controllers provide essential authentication services. The following are symptoms of an under-resourced Domain Control environment:

- Domain logons intermittently fail.
- File access on a Domain Member server intermittently fails, giving a permission denied error message.

A more scalable Domain Control authentication backend option might use Microsoft Active Directory, or an LDAP-based backend. Samba-3 provides for both options as a Domain Member server. As a PDC Samba-3 is not able to provide an exact alternative to the functionality that is available with Active Directory. Samba-3 can provide a scalable LDAP-based PDC/BDC solution.

The `tdbsam` authentication backend provides no facility to replicate the contents of the database, except by external means. (i.e., there is no self-contained protocol in Samba-3 for Security Account Manager database [SAM] replication.)

NOTE



If you need more than one Domain Controller, do not use a tdbsam authentication backend.

2.3.3.1 Example: Engineering Office

The engineering office network server we present here is designed to demonstrate use of the new tdbsam password backend. The tdbsam facility is new to Samba-3. It is designed to provide many user and machine account controls that are possible with Microsoft Windows NT4. It is safe to use this in smaller networks.

1. A working PDC configuration using the tdbsam password backend can be found in Example 2.3.7 together with Example 2.3.8:

Example 2.3.7. Engineering Office smb.conf (globals)

```
[global]
    workgroup = MIDEARTH
    netbios name = FR0DD
    passdb backend = tdbsam
    printcap name = cups
    add user script = /usr/sbin/useradd -m %u
    delete user script = /usr/sbin/userdel -r %u
    add group script = /usr/sbin/groupadd %g
    delete group script = /usr/sbin/groupdel %g
    add user to group script = /usr/sbin/usermod -G %g %u
    add machine script = /usr/sbin/useradd -s /bin/false \
-d /dev/null %u
# Note: The following specifies the default logon script.
# Per user logon scripts can be specified in the user account using pdbedit
    logon script = scripts\logon.bat
# This sets the default profile path. Set per user paths with pdbedit
    logon path = \\%L\Profiles\%U
    logon drive = H:
    logon home = \\%L\%U
    domain logons = Yes
    os level = 35
    preferred master = Yes
    domain master = Yes
    idmap uid = 15000-20000
    idmap gid = 15000-20000
    printing = cups
```

2. Create UNIX group accounts as needed using a suitable operating system tool:

```
root# groupadd ntadmins
root# groupadd designers
root# groupadd engineers
root# groupadd qateam
```

3. Create user accounts on the system using the appropriate tool provided with the operating system. Make sure all user home directories are created also. Add users to groups as required for access control on files, directories, printers, and as required for use in the Samba environment.
4. Assign each of the UNIX groups to NT groups: (It may be useful to copy this text to a shell script called `initGroups.sh`.) Shell script for initializing group mappings

```
#!/bin/bash
#### Keep this as a shell script for future re-use

# First assign well known groups
net groupmap modify ntgroup="Domain Admins" unixgroup=ntadmins rid=512
net groupmap modify ntgroup="Domain Users" unixgroup=users rid=513
net groupmap modify ntgroup="Domain Guests" unixgroup=nobody rid=514

# Now for our added Domain Groups
net groupmap add ntgroup="Designers" unixgroup=designers type=d rid=1112
net groupmap add ntgroup="Engineers" unixgroup=engineers type=d rid=1113
net groupmap add ntgroup="QA Team" unixgroup=qateam type=d rid=1114
```

5. Create the `scripts` directory for use in the `[NETLOGON]` share:

```
root# mkdir -p /var/lib/samba/netlogon/scripts
```

Place the logon scripts that will be used (batch or cmd scripts) in this directory.

The above configuration provides a functional Primary Domain Control (PDC) system to which must be added file shares and printers as required.

2.3.3.2 A Big Organization

In this section we finally get to review in brief a Samba-3 configuration that uses a Light Weight Directory Access (LDAP)-based authentication backend. The main reasons for this choice are to provide the ability to host primary and Backup Domain Control (BDC), as well as to enable a higher degree of scalability to meet the needs of a very distributed environment.

The Primary Domain Controller This is an example of a minimal configuration to run a Samba-3 PDC using an LDAP authentication backend. It is assumed that the operating system has been correctly configured.

The Idealx scripts (or equivalent) are needed to manage LDAP based Posix and/or SambaSamAccounts. The Idealx scripts may be downloaded from the Idealx <<http://www.idealx.org>> Web site. They may also be obtained from the Samba tarball. Linux distributions tend to install the Idealx scripts in the `/usr/share/doc/packages/sambaXXXXXX/examples/LDAP/smbldap-tools` directory. Idealx scripts version `smbldap-tools-0.8.2` are known to work well.

1. Obtain from the Samba sources `~/examples/LDAP/samba.schema` and copy it to the `/etc/openldap/schema/` directory.
2. Set up the LDAP server. This example is suitable for OpenLDAP 2.1.x. The `/etc/openldap/slapd.conf` file: Example `slapd.conf` file

```
# Note commented out lines have been removed
include      /etc/openldap/schema/core.schema
include      /etc/openldap/schema/cosine.schema
include      /etc/openldap/schema/inetorgperson.schema
include      /etc/openldap/schema/nis.schema
include      /etc/openldap/schema/samba.schema

pidfile      /var/run/slapd/slapd.pid
argsfile     /var/run/slapd/slapd.args

database     bdb
suffix       "dc=quenya,dc=org"
rootdn       "cn=Manager,dc=quenya,dc=org"
rootpw       {SSHA}06qDkonA8hk6W6SSnRzWj0/pBcU3m0/P
# The password for the above is 'nastyon3'

directory   /var/lib/ldap

index  objectClass      eq
index  cn                pres,sub,eq
index  sn                pres,sub,eq
index  uid               pres,sub,eq
index  displayName      pres,sub,eq
index  uidNumber        eq
index  gidNumber        eq
index  memberUid        eq
index  sambaSID         eq
index  sambaPrimaryGroupSID eq
index  sambaDomainName  eq
index  default          sub
```

3. Create the following file `samba-ldap-init.ldif`:

```
# Organization for SambaXP Demo
dn: dc=kenya,dc=org
objectclass: dcObject
objectclass: organization
dc: kenya
o: SambaXP Demo
description: The SambaXP Demo LDAP Tree

# Organizational Role for Directory Management
dn: cn=Manager,dc=kenya,dc=org
objectclass: organizationalRole
cn: Manager
description: Directory Manager

# Setting up the container for users
dn: ou=People, dc=kenya, dc=org
objectclass: top
objectclass: organizationalUnit
ou: People

# Set up an admin handle for People OU
dn: cn=admin, ou=People, dc=kenya, dc=org
cn: admin
objectclass: top
objectclass: organizationalRole
objectclass: simpleSecurityObject
userPassword: {SSHA}OjBHgQ1vp4EDX2rEMMfIudvRMJoGwjVb
# The password for above is 'mordonL8'
```

4. Load the initial data above into the LDAP database:

```
root# slapadd -v -l initdb.ldif
```

5. Start the LDAP server using the appropriate tool or method for the operating system platform on which it is installed.
6. Install the Idealx script files in the `/usr/local/sbin` directory, then configure the `smbldap_conf.pm` file to match your system configuration.
7. The `smb.conf` file that drives this backend can be found in example Example 2.3.9.
8. Add the LDAP password to the `secrets.tdc` file so Samba can update the LDAP database:

```
root# smbpasswd -w mordonL8
```

9. Add users and groups as required. Users and groups added using Samba tools will automatically be added to both the LDAP backend as well as to the operating system as required.

Backup Domain Controller Example 2.3.10 shows the example configuration for the BDC.

1. Decide if the BDC should have its own LDAP server or not. If the BDC is to be the LDAP server change the following `smb.conf` as indicated. The default configuration in Example 2.3.10 uses a central LDAP server.
2. Configure the NETLOGON and PROFILES directory as for the PDC in Example 2.3.10.

Example 2.3.8. Engineering Office smb.conf (shares and services)

```
[homes]
    comment = Home Directories
    valid users = %S
    read only = No
    browseable = No
# Printing auto-share (makes printers available thru CUPS)

[printers]
    comment = All Printers
    path = /var/spool/samba
    printer admin = root, maryo
    create mask = 0600
    guest ok = Yes
    printable = Yes
    browseable = No

[print$]
    comment = Printer Drivers Share
    path = /var/lib/samba/drivers
    write list = maryo, root
    printer admin = maryo, root
# Needed to support domain logons

[netlogon]
    comment = Network Logon Service
    path = /var/lib/samba/netlogon
    admin users = root, maryo
    guest ok = Yes
    browseable = No
# For profiles to work, create a user directory under the path
# shown. i.e., mkdir -p /var/lib/samba/profiles/maryo

[Profiles]
    comment = Roaming Profile Share
    path = /var/lib/samba/profiles
    read only = No
    profile acls = Yes
# Other resource (share/printer) definitions would follow below.
...
```

Example 2.3.9. LDAP backend smb.conf for PDC

Global parameters

```
[global]
    workgroup = MIDEARTH
    netbios name = FRODO
    passdb backend = ldapsam:ldap://localhost
    username map = /etc/samba/smbusers
    printcap name = cups
    add user script = /usr/local/sbin/smbldap-useradd.pl -m '%u'
    delete user script = /usr/local/sbin/smbldap-userdel.pl %u
    add group script = /usr/local/sbin/smbldap-groupadd.pl -p '%g'
    delete group script = /usr/local/sbin/smbldap-groupdel.pl '%g'
    add user to group script = /usr/local/sbin/ \
smbldap-groupmod.pl -m '%g' '%u'
    delete user from group script = /usr/local/sbin/ \
smbldap-groupmod.pl -x '%g' '%u'
    set primary group script = /usr/local/sbin/ \
smbldap-usermod.pl -g '%g' '%u'
    add machine script = /usr/local/sbin/smbldap-useradd.pl -w '%u'
    logon script = scripts\logon.bat
    logon path = \\%L\Profiles\%U
    logon drive = H:
    logon home = \\%L\%U
    domain logons = Yes
    os level = 35
    preferred master = Yes
    domain master = Yes
    ldap suffix = dc=kenya,dc=org
    ldap machine suffix = ou=People
    ldap user suffix = ou=People
    ldap group suffix = ou=People
    ldap idmap suffix = ou=People
    ldap admin dn = cn=Manager
    ldap ssl = no
    ldap passwd sync = Yes
    idmap uid = 15000-20000
    idmap gid = 15000-20000
    printing = cups
```

...

Example 2.3.10. Remote LDAP BDC smb.conf

Global parameters

```
[global]
workgroup = MIDEARTH
netbios name = GANDALF
passdb backend = ldapsam:ldap://frodo.quenya.org
username map = /etc/samba/smbusers
printcap name = cups
logon script = scripts\logon.bat
logon path = \\%L\Profiles\%U
logon drive = H:
logon home = \\%L\%U
domain logons = Yes
os level = 33
preferred master = Yes
domain master = No
ldap suffix = dc=quenya,dc=org
ldap machine suffix = ou=People
ldap user suffix = ou=People
ldap group suffix = ou=People
ldap idmap suffix = ou=People
ldap admin dn = cn=Manager
ldap ssl = no
ldap passwd sync = Yes
idmap uid = 15000-20000
idmap gid = 15000-20000
printing = cups
```

...

Part II

Server Configuration Basics

FIRST STEPS IN SERVER CONFIGURATION

Samba can operate in various modes within SMB networks. This HOWTO section contains information on configuring Samba to function as the type of server your network requires. Please read this section carefully.

SERVER TYPES AND SECURITY MODES

This chapter provides information regarding the types of server that Samba may be configured to be. A Microsoft network administrator who wishes to migrate to or use Samba will want to know the meaning, within a Samba context, of terms familiar to MS Windows administrator. This means that it is essential also to define how critical security modes function before we get into the details of how to configure the server itself.

The chapter provides an overview of the security modes of which Samba is capable and how they relate to MS Windows servers and clients.

A question often asked is, “*Why would I want to use Samba?*” Most chapters contain a section that highlights features and benefits. We hope that the information provided will help to answer this question. Be warned though, we want to be fair and reasonable, so not all features are positive towards Samba. The benefit may be on the side of our competition.

3.1 Features and Benefits

Two men were walking down a dusty road, when one suddenly kicked up a small red stone. It hurt his toe and lodged in his sandal. He took the stone out and cursed it with a passion and fury befitting his anguish. The other looked at the stone and said, “*This is a garnet. I can turn that into a precious gem and some day it will make a princess very happy!*”

The moral of this tale: Two men, two very different perspectives regarding the same stone. Like it or not, Samba is like that stone. Treat it the right way and it can bring great pleasure, but if you are forced to use it and have no time for its secrets, then it can be a source of discomfort.

Samba started out as a project that sought to provide interoperability for MS Windows 3.x clients with a UNIX server. It has grown up a lot since its humble beginnings and now provides features and functionality fit for large scale deployment. It also has some warts. In sections like this one we tell of both.

So, what are the benefits of features mentioned in this chapter?

- Samba-3 can replace an MS Windows NT4 Domain Controller.

- Samba-3 offers excellent interoperability with MS Windows NT4-style domains as well as natively with Microsoft Active Directory domains.
- Samba-3 permits full NT4-style Interdomain Trusts.
- Samba has security modes that permit more flexible authentication than is possible with MS Windows NT4 Domain Controllers.
- Samba-3 permits use of multiple account database backends.
- The account (password) database backends can be distributed and replicated using multiple methods. This gives Samba-3 greater flexibility than MS Windows NT4 and in many cases a significantly higher utility than Active Directory domains with MS Windows 200x.

3.2 Server Types

Administrators of Microsoft networks often refer to three different type of servers:

- Domain Controller
 - Primary Domain Controller
 - Backup Domain Controller
 - ADS Domain Controller
- Domain Member Server
 - Active Directory Domain Server
 - NT4 Style Domain Domain Server
- Stand-alone Server

The chapters covering Domain Control, Backup Domain Control and Domain Membership provide pertinent information regarding Samba configuration for each of these server roles. The reader is strongly encouraged to become intimately familiar with the information presented.

3.3 Samba Security Modes

In this section the function and purpose of Samba's security modes are described. An accurate understanding of how Samba implements each security mode as well as how to configure MS Windows clients for each mode will significantly reduce user complaints and administrator heartache.

In the SMB/CIFS networking world, there are only two types of security: *User Level* and *Share Level*. We refer to these collectively as *security levels*. In implementing these two security levels, Samba provides flexibilities that are not available with Microsoft Windows NT4/200x servers. In actual fact, Samba implements *Share Level* security only one way, but has four ways of implementing *User Level* security. Collectively, we call the Samba

implementations *Security Modes*. They are known as: *SHARE*, *USER*, *DOMAIN*, *ADS*, and *SERVER* modes. They are documented in this chapter.

An SMB server tells the client at startup what security level it is running. There are two options: Share Level and User Level. Which of these two the client receives affects the way the client then tries to authenticate itself. It does not directly affect (to any great extent) the way the Samba server does security. This may sound strange, but it fits in with the client/server approach of SMB. In SMB everything is initiated and controlled by the client, and the server can only tell the client what is available and whether an action is allowed.

3.3.1 User Level Security

We will describe User Level Security first, as its simpler. In User Level Security, the client will send a session setup request directly following protocol negotiation. This request provides a username and password. The server can either accept or reject that username/password combination. At this stage the server has no idea what share the client will eventually try to connect to, so it can't base the *accept/reject* on anything other than:

1. the username/password.
2. the name of the client machine.

If the server accepts the username/password then the client expects to be able to mount shares (using a *tree connection*) without specifying a password. It expects that all access rights will be as the username/password specified in the *session setup*.

It is also possible for a client to send multiple *session setup* requests. When the server responds, it gives the client a *uid* to use as an authentication tag for that username/password. The client can maintain multiple authentication contexts in this way (WinDD is an example of an application that does this).

3.3.1.1 Example Configuration

The `smb.conf` parameter that sets user level security is:

```
security = user
```

This is the default setting since Samba-2.2.x.

3.3.2 Share Level Security

In Share Level security, the client authenticates itself separately for each share. It sends a password along with each tree connection (share mount). It does not explicitly send a username with this operation. The client expects a password to be associated with each share, independent of the user. This means that Samba has to work out what username the client probably wants to use. It is never explicitly sent the username. Some commercial SMB servers such as NT actually associate passwords directly with shares in Share Level security, but Samba always uses the UNIX authentication scheme where it is a username/password pair that is authenticated, not a share/password pair.

To understand the MS Windows networking parallels, one should think in terms of MS Windows 9x/Me where one can create a shared folder that provides read-only or full access, with or without a password.

Many clients send a session setup even if the server is in Share Level security. They normally send a valid username but no password. Samba records this username in a list of possible usernames. When the client then does a tree connection it also adds to this list the name of the share they try to connect to (useful for home directories) and any users listed in the user parameter in the `smb.conf` file. The password is then checked in turn against these possible usernames. If a match is found then the client is authenticated as that user.

3.3.2.1 Example Configuration

The `smb.conf` parameter that sets Share Level security is:

```
security = share
```

3.3.3 Domain Security Mode (User Level Security)

When Samba is operating in `security = domain` mode, the Samba server has a domain security trust account (a machine account) and causes all authentication requests to be passed through to the Domain Controllers. In other words, this configuration makes the Samba server a Domain Member server.

3.3.3.1 Example Configuration

Samba as a Domain Member Server

This method involves addition of the following parameters in the `smb.conf` file:

```
security = domain  
workgroup = MIDEARTH
```

In order for this method to work, the Samba server needs to join the MS Windows NT security domain. This is done as follows:

1. On the MS Windows NT Domain Controller, using the Server Manager, add a machine account for the Samba server.
2. On the UNIX/Linux system execute:

```
root# net rpc join -U administrator%password
```

NOTE

Samba-2.2.4 and later can auto-join a Windows NT4-style Domain just by executing:

```
root# smbpasswd -j DOMAIN_NAME -r PDC_NAME \
-U Administrator%password
```



Samba-3 can do the same by executing:

```
root# net rpc join -U Administrator%password
```

It is not necessary with Samba-3 to specify the *DOMAIN_NAME* or the *PDC_NAME* as it figures this out from the *smb.conf* file settings.

Use of this mode of authentication does require there to be a standard UNIX account for each user in order to assign a UID once the account has been authenticated by the remote Windows DC. This account can be blocked to prevent logons by clients other than MS Windows through means such as setting an invalid shell in the */etc/passwd* entry.

An alternative to assigning UIDs to Windows users on a Samba member server is presented in Winbind: Use of Domain Accounts.

For more information regarding Domain Membership, see Domain Membership.

3.3.4 ADS Security Mode (User Level Security)

Both Samba-2.2, and Samba-3 can join an Active Directory domain. This is possible if the domain is run in native mode. Active Directory in native mode perfectly allows NT4-style Domain Members. This is contrary to popular belief. Active Directory in native mode prohibits only the use of Backup Domain Controllers running MS Windows NT4.

If you are using Active Directory, starting with Samba-3 you can join as a native AD member. Why would you want to do that? Your security policy might prohibit the use of NT-compatible authentication protocols. All your machines are running Windows 2000 and above and all use Kerberos. In this case Samba as an NT4-style domain would still require NT-compatible authentication data. Samba in AD-member mode can accept Kerberos tickets.

3.3.4.1 Example Configuration

```
realm = your.kerberos.REALM
security = ADS
```

The following parameter may be required:

password server = your.kerberos.server

Please refer to Domain Membership and Samba ADS Domain Membership for more information regarding this configuration option.

3.3.5 Server Security (User Level Security)

Server Security Mode is left over from the time when Samba was not capable of acting as a Domain Member server. It is highly recommended not to use this feature. Server security mode has many drawbacks that include:

- Potential Account Lockout on MS Windows NT4/200x password servers.
- Lack of assurance that the password server is the one specified.
- Does not work with Winbind, which is particularly needed when storing profiles remotely.
- This mode may open connections to the password server, and keep them open for extended periods.
- Security on the Samba server breaks badly when the remote password server suddenly shuts down.
- With this mode there is NO security account in the domain that the password server belongs to for the Samba server.

In Server Security Mode the Samba server reports to the client that it is in User Level security. The client then does a session setup as described earlier. The Samba server takes the username/password that the client sends and attempts to login to the password server by sending exactly the same username/password that it got from the client. If that server is in User Level Security and accepts the password, then Samba accepts the client's connection. This allows the Samba server to use another SMB server as the password server.

You should also note that at the start of all this where the server tells the client what security level it is in, it also tells the client if it supports encryption. If it does, it supplies the client with a random cryptkey. The client will then send all passwords in encrypted form. Samba supports this type of encryption by default.

The parameter `security = server` means that Samba reports to clients that it is running in *user mode* but actually passes off all authentication requests to another *user mode* server. This requires an additional parameter `password server` that points to the real authentication server. The real authentication server can be another Samba server, or it can be a Windows NT server, the latter being natively capable of encrypted password support.

NOTE

When Samba is running in *Server Security Mode* it is essential that the parameter *password server* is set to the precise NetBIOS machine name of the target authentication server. Samba cannot determine this from NetBIOS name lookups because the choice of the target authentication server is arbitrary and cannot be determined from a domain name. In essence, a Samba server that is in *Server Security Mode* is operating in what used to be known as workgroup mode.

3.3.5.1 Example Configuration

Using MS Windows NT as an Authentication Server

This method involves the additions of the following parameters in the `smb.conf` file:

```
encrypt passwords = Yes
security = server
password server = "NetBIOS_name_of_a_DC"
```

There are two ways of identifying whether or not a username and password pair is valid. One uses the reply information provided as part of the authentication messaging process, the other uses just an error code.

The downside of this mode of configuration is the fact that for security reasons Samba will send the password server a bogus username and a bogus password and if the remote server fails to reject the username and password pair then an alternative mode of identification of validation is used. Where a site uses password lock out after a certain number of failed authentication attempts this will result in user lockouts.

Use of this mode of authentication requires a standard UNIX account for the user. This account can be blocked to prevent logons by non-SMB/CIFS clients.

3.4 Password Checking

MS Windows clients may use encrypted passwords as part of a challenge/response authentication model (a.k.a. NTLMv1 and NTLMv2) or alone, or clear-text strings for simple password-based authentication. It should be realized that with the SMB protocol, the password is passed over the network either in plain-text or encrypted, but not both in the same authentication request.

When encrypted passwords are used, a password that has been entered by the user is encrypted in two ways:

- An MD4 hash of the unicode of the password string. This is known as the NT hash.
- The password is converted to upper case, and then padded or truncated to 14 bytes. This string is then appended with 5 bytes of NULL characters and split to form two

56-bit DES keys to encrypt a “*magic*” 8-byte value. The resulting 16 bytes form the LanMan hash.

MS Windows 95 pre-service pack 1, MS Windows NT versions 3.x and version 4.0 pre-service pack 3 will use either mode of password authentication. All versions of MS Windows that follow these versions no longer support plain text passwords by default.

MS Windows clients have a habit of dropping network mappings that have been idle for 10 minutes or longer. When the user attempts to use the mapped drive connection that has been dropped, the client re-establishes the connection using a cached copy of the password.

When Microsoft changed the default password mode, support was dropped for caching of the plain-text password. This means that when the registry parameter is changed to re-enable use of plain-text passwords it appears to work, but when a dropped service connection mapping attempts to revalidate, this will fail if the remote authentication server does not support encrypted passwords. It is definitely not a good idea to re-enable plain-text password support in such clients.

The following parameters can be used to work around the issue of Windows 9x/Me clients upper-casing usernames and passwords before transmitting them to the SMB server when using clear-text authentication:

```
password level = integer  
username level = integer
```

By default Samba will convert to lower case the username before attempting to lookup the user in the database of local system accounts. Because UNIX usernames conventionally only contain lower-case characters, the username level parameter is rarely needed.

However, passwords on UNIX systems often make use of mixed-case characters. This means that in order for a user on a Windows 9x/Me client to connect to a Samba server using clear-text authentication, the password level must be set to the maximum number of upper case letters that *could* appear in a password. Note that if the server OS uses the traditional DES version of `crypt()`, a password level of 8 will result in case insensitive passwords as seen from Windows users. This will also result in longer login times as Samba has to compute the permutations of the password string and try them one by one until a match is located (or all combinations fail).

The best option to adopt is to enable support for encrypted passwords wherever Samba is used. Most attempts to apply the registry change to re-enable plain-text passwords will eventually lead to user complaints and unhappiness.

3.5 Common Errors

We all make mistakes. It is okay to make mistakes, as long as they are made in the right places and at the right time. A mistake that causes lost productivity is seldom tolerated, however a mistake made in a developmental test lab is expected.

Here we look at common mistakes and misapprehensions that have been the subject of discussions on the Samba mailing lists. Many of these are avoidable by doing your homework before attempting a Samba implementation. Some are the result of a misunderstanding of

the English language. The English language, which has many phrases that are potentially vague and may be highly confusing to those for whom English is not their native tongue.

3.5.1 What Makes Samba a Server?

To some the nature of the Samba *security* mode is obvious, but entirely wrong all the same. It is assumed that `security = server` means that Samba will act as a server. Not so! This setting means that Samba will *try* to use another SMB server as its source for user authentication alone.

3.5.2 What Makes Samba a Domain Controller?

The `smb.conf` parameter `security = domain` does not really make Samba behave as a Domain Controller. This setting means we want Samba to be a Domain Member. See Samba as a PDC for more information.

3.5.3 What Makes Samba a Domain Member?

Guess! So many others do. But whatever you do, do not think that `security = user` makes Samba act as a Domain Member. Read the manufacturer's manual before the warranty expires. See Domain Membership for more information.

3.5.4 Constantly Losing Connections to Password Server

“Why does `server_validate()` simply give up rather than re-establish its connection to the password server? Though I am not fluent in the SMB protocol, perhaps the cluster server process passes along to its client workstation the session key it receives from the password server, which means the password hashes submitted by the client would not work on a subsequent connection whose session key would be different. So `server_validate()` must give up.”

Indeed. That's why `security = server` is at best a nasty hack. Please use `security = domain`; `security = server` mode is also known as pass-through authentication.

DOMAIN CONTROL

There are many who approach MS Windows networking with incredible misconceptions. That's okay, because it gives the rest of us plenty of opportunity to be of assistance. Those who really want help would be well advised to become familiar with information that is already available.

The reader is advised not to tackle this section without having first understood and mastered some basics. MS Windows networking is not particularly forgiving of mis-configuration. Users of MS Windows networking are likely to complain of persistent niggles that may be caused by a broken network configuration. To a great many people, however, MS Windows networking starts with a Domain Controller that in some magical way is expected to solve all network operational ills.

The diagram shows a typical MS Windows Domain Security network environment. Workstations A, B and C are representative of many physical MS Windows network clients.

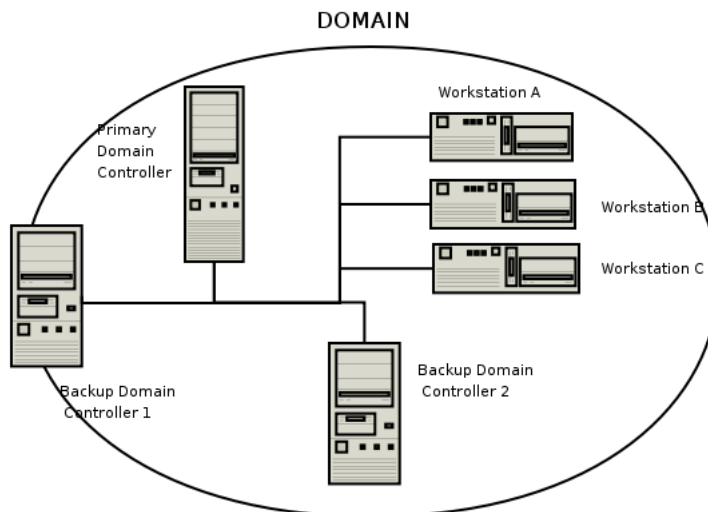

Figure 4.1.

From the Samba mailing list one can readily identify many common networking issues. If you are not clear on the following subjects, then it will do much good to read the sections of this HOWTO that deal with it. These are the most common causes of MS Windows networking problems:

- Basic TCP/IP configuration.
- NetBIOS name resolution.
- Authentication configuration.
- User and group configuration.
- Basic file and directory permission control in UNIX/Linux.
- Understanding how MS Windows clients interoperate in a network environment.

Do not be put off; on the surface of it MS Windows networking seems so simple that anyone can do it. In fact, it is not a good idea to set up an MS Windows network with inadequate training and preparation. But let's get our first indelible principle out of the way: *It is perfectly okay to make mistakes!* In the right place and at the right time, mistakes are the essence of learning. It is very much not okay to make mistakes that cause loss of productivity and impose an avoidable financial burden on an organization.

Where is the right place to make mistakes? Only out of harms way. If you are going to make mistakes, then please do it on a test network, away from users and in such a way as to not inflict pain on others. Do your learning on a test network.

4.1 Features and Benefits

What is the key benefit of Microsoft Domain Security?

In a word, *Single Sign On*, or SSO for short. To many, this is the Holy Grail of MS Windows NT and beyond networking. SSO allows users in a well-designed network to log onto any workstation that is a member of the domain that their user account is in (or in a domain that has an appropriate trust relationship with the domain they are visiting) and they will be able to log onto the network and access resources (shares, files and printers) as if they are sitting at their home (personal) workstation. This is a feature of the Domain Security protocols.

The benefits of Domain Security are available to those sites that deploy a Samba PDC. A Domain provides a unique network security identifier (SID). Domain user and group security identifiers are comprised of the network SID plus a relative identifier (RID) that is unique to the account. User and Group SIDs (the network SID plus the RID) can be used to create Access Control Lists (ACLs) attached to network resources to provide organizational access control. UNIX systems recognize only local security identifiers.

NOTE



Network clients of an MS Windows Domain Security Environment must be Domain Members to be able to gain access to the advanced features provided. Domain Membership involves more than just setting the workgroup name to the Domain name. It requires the creation of a Domain trust account for the workstation (called a machine account). Refer to Domain Membership for more information.

The following functionalities are new to the Samba-3 release:

- Windows NT4 domain trusts.
- Adding users via the User Manager for Domains. This can be done on any MS Windows client using the `Nexus.exe` toolkit for Windows 9x/Me, or using the `SRV-TOOLS.EXE` package for MS Windows NT4/200x/XP platforms. These packages are available from Microsoft's Web site.
- Introduces replaceable and multiple user account (authentication) backends. In the case where the backend is placed in an LDAP database, Samba-3 confers the benefits of a backend that can be distributed, replicated and is highly scalable.
- Implements full Unicode support. This simplifies cross locale internationalization support. It also opens up the use of protocols that Samba-2.2.x had but could not use due to the need to fully support Unicode.

The following functionalities are not provided by Samba-3:

- SAM replication with Windows NT4 Domain Controllers (i.e., a Samba PDC and a Windows NT BDC or vice versa). This means Samba cannot operate as a BDC when the PDC is Microsoft-based or replicate account data to Windows BDCs.
- Acting as a Windows 2000 Domain Controller (i.e., Kerberos and Active Directory). In point of fact, Samba-3 does have some Active Directory Domain Control ability that is at this time purely experimental that is certain to change as it becomes a fully supported feature some time during the Samba-3 (or later) life cycle. However, Active Directory is more than just SMB — it's also LDAP, Kerberos, DHCP, and other protocols (with proprietary extensions, of course).
- The Windows 200x/XP MMC (Computer Management) Console can not be used to manage a Samba-3 server. For this you can use only the MS Windows NT4 Domain Server manager and the MS Windows NT4 Domain User Manager. Both are part of the `SVRTOOLS.EXE` package mentioned later.

Windows 9x/Me/XP Home clients are not true members of a domain for reasons outlined in this chapter. The protocol for support of Windows 9x/Me style network (domain) logons is completely different from NT4/Windows 200x type domain logons and has been officially supported for some time. These clients use the old LanMan Network Logon facilities that are supported in Samba since approximately the Samba-1.9.15 series.

Samba-3 implements group mapping between Windows NT groups and UNIX groups (this

is really quite complicated to explain in a short space). This is discussed more fully in Group Mapping — MS Windows and UNIX.

Samba-3, like an MS Windows NT4 PDC or a Windows 200x Active Directory, needs to store user and Machine Trust Account information in a suitable backend data-store. Refer to MS Windows Workstation/Server Machine Trust Accounts. With Samba-3 there can be multiple backends for this. A complete discussion of account database backends can be found in Account Information Databases.

4.2 Basics of Domain Control

Over the years, public perceptions of what Domain Control really is has taken on an almost mystical nature. Before we branch into a brief overview of Domain Control, there are three basic types of Domain Controllers.

4.2.1 Domain Controller Types

- Primary Domain Controller
- Backup Domain Controller
- ADS Domain Controller

The *Primary Domain Controller* or PDC plays an important role in MS Windows NT4. In Windows 200x Domain Control architecture, this role is held by Domain Controllers. Folklore dictates that because of its role in the MS Windows network, the Domain Controller should be the most powerful and most capable machine in the network. As strange as it may seem to say this here, good overall network performance dictates that the entire infrastructure needs to be balanced. It is advisable to invest more in Stand-alone (Domain Member) servers than in the Domain Controllers.

In the case of MS Windows NT4-style domains, it is the PDC that initiates a new Domain Control database. This forms a part of the Windows registry called the Security Account Manager (SAM). It plays a key part in NT4-type domain user authentication and in synchronization of the domain authentication database with Backup Domain Controllers.

With MS Windows 200x Server-based Active Directory domains, one Domain Controller initiates a potential hierarchy of Domain Controllers, each with their own area of delegated control. The master domain controller has the ability to override any downstream controller, but a down-line controller has control only over its down-line. With Samba-3, this functionality can be implemented using an LDAP-based user and machine account backend.

New to Samba-3 is the ability to use a backend database that holds the same type of data as the NT4-style SAM database (one of the registry files)¹.

The *Backup Domain Controller* or BDC plays a key role in servicing network authentication requests. The BDC is biased to answer logon requests in preference to the PDC. On a network segment that has a BDC and a PDC, the BDC will most likely service network logon requests. The PDC will answer network logon requests when the BDC is too busy

¹See also Account Information Databases.

(high load). A BDC can be promoted to a PDC. If the PDC is online at the time that a BDC is promoted to PDC, the previous PDC is automatically demoted to a BDC. With Samba-3, this is not an automatic operation; the PDC and BDC must be manually configured and changes also need to be made.

With MS Windows NT4, a decision is made at installation to determine what type of machine the server will be. It is possible to promote a BDC to a PDC and vice versa. The only way to convert a Domain Controller to a Domain Member server or a Stand-alone Server is to reinstall it. The install time choices offered are:

- *Primary Domain Controller* — the one that seeds the domain SAM.
- *Backup Domain Controller* — one that obtains a copy of the domain SAM.
- *Domain Member Server* — one that has no copy of the domain SAM, rather it obtains authentication from a Domain Controller for all access controls.
- *Stand-alone Server* — one that plays no part in SAM synchronization, has its own authentication database and plays no role in Domain Security.

With MS Windows 2000, the configuration of Domain Control is done after the server has been installed. Samba-3 is capable of acting fully as a native member of a Windows 200x server Active Directory domain.

New to Samba-3 is the ability to function fully as an MS Windows NT4-style Domain Controller, excluding the SAM replication components. However, please be aware that Samba-3 also supports the MS Windows 200x Domain Control protocols.

At this time any appearance that Samba-3 is capable of acting as a *Domain Controller* in native ADS mode is limited and experimental in nature. This functionality should not be used until the Samba Team offers formal support for it. At such a time, the documentation will be revised to duly reflect all configuration and management requirements. Samba can act as a NT4-style DC in a Windows 2000/XP environment. However, there are certain compromises:

- No machine policy files.
- No Group Policy Objects.
- No synchronously executed AD logon scripts.
- Can't use Active Directory management tools to manage users and machines.
- Registry changes tattoo the main registry, while with AD they do not leave permanent changes in effect.
- Without AD you cannot perform the function of exporting specific applications to specific users or groups.

4.2.2 Preparing for Domain Control

There are two ways that MS Windows machines may interact with each other, with other servers and with Domain Controllers: either as *Stand-alone* systems, more commonly called

Workgroup members, or as full participants in a security system, more commonly called *Domain* members.

It should be noted that *Workgroup* membership involves no special configuration other than the machine being configured so the network configuration has a commonly used name for its workgroup entry. It is not uncommon for the name WORKGROUP to be used for this. With this mode of configuration, there are no Machine Trust Accounts and any concept of membership as such is limited to the fact that all machines appear in the network neighborhood to be logically grouped together. Again, just to be clear: *workgroup mode does not involve security machine accounts*.

Domain Member machines have a machine account in the Domain accounts database. A special procedure must be followed on each machine to effect Domain Membership. This procedure, which can be done only by the local machine Administrator account, will create the Domain machine account (if it does not exist), and then initializes that account. When the client first logs onto the Domain it triggers a machine password change.

NOTE



When Samba is configured as a Domain Controller, secure network operation demands that all MS Windows NT4/200x/XP Professional clients should be configured as Domain Members. If a machine is not made a member of the Domain, then it will operate like a workgroup (Stand-alone) machine. Please refer to Domain Membership chapter for information regarding Domain Membership.

The following are necessary for configuring Samba-3 as an MS Windows NT4-style PDC for MS Windows NT4/200x/XP clients:

- Configuration of basic TCP/IP and MS Windows networking.
- Correct designation of the Server Role (security = user).
- Consistent configuration of Name Resolution².
- Domain logons for Windows NT4/200x/XP Professional clients.
- Configuration of Roaming Profiles or explicit configuration to force local profile usage.
- Configuration of network/system policies.
- Adding and managing domain user accounts.
- Configuring MS Windows client machines to become Domain Members.

The following provisions are required to serve MS Windows 9x/Me clients:

- Configuration of basic TCP/IP and MS Windows networking.
- Correct designation of the server role (security = user).

²See Network Browsing, and Integrating MS Windows Networks with Samba.

- Network Logon Configuration (since Windows 9x/Me/XP Home are not technically domain members, they do not really participate in the security aspects of Domain logons as such).
- Roaming Profile Configuration.
- Configuration of System Policy handling.
- Installation of the network driver “*Client for MS Windows Networks*” and configuration to log onto the domain.
- Placing Windows 9x/Me clients in User Level Security — if it is desired to allow all client share access to be controlled according to domain user/group identities.
- Adding and managing domain user accounts.

NOTE



Roaming Profiles and System/Network policies are advanced network administration topics that are covered in the Desktop Profile Management and System and Account Policies chapters of this document. However, these are not necessarily specific to a Samba PDC as much as they are related to Windows NT networking concepts.

A Domain Controller is an SMB/CIFS server that:

- Registers and advertises itself as a Domain Controller (through NetBIOS broadcasts as well as by way of name registrations either by Mailslot Broadcasts over UDP broadcast, to a WINS server over UDP uni-cast, or via DNS and Active Directory).
- Provides the NETLOGON service. (This is actually a collection of services that runs over multiple protocols. These include the LanMan Logon service, the Netlogon service, the Local Security Account service, and variations of them.)
- Provides a share called NETLOGON.

It is rather easy to configure Samba to provide these. Each Samba Domain Controller must provide the NETLOGON service that Samba calls the domain logons functionality (after the name of the parameter in the `smb.conf` file). Additionally, one server in a Samba-3 Domain must advertise itself as the Domain Master Browser³. This causes the Primary Domain Controller to claim a domain-specific NetBIOS name that identifies it as a Domain Master Browser for its given domain or workgroup. Local master browsers in the same domain or workgroup on broadcast-isolated subnets then ask for a complete copy of the browse list for the whole wide area network. Browser clients will then contact their Local Master Browser, and will receive the domain-wide browse list, instead of just the list for their broadcast-isolated subnet.

³See Network Browsing.

4.3 Domain Control — Example Configuration

The first step in creating a working Samba PDC is to understand the parameters necessary in `smb.conf`. An example `smb.conf` for acting as a PDC can be found in the next example.

Example 4.3.1. `smb.conf` for being a PDC

```
[global]
    netbios name = BELERIAND
    workgroup = MIDEARTH
    passdb backend = tdbsam
    os level = 33
    preferred master = yes
    domain master = yes
    local master = yes
    security = user
    domain logons = yes
    logon path = \\%N\profiles\%U
    logon drive = H:
    logon home = \\homeserver\%U\winprofile
    logon script = logon.cmd

[netlogon]
    path = /var/lib/samba/netlogon
    read only = yes
    write list = ntadmin

[profiles]
    path = /var/lib/samba/profiles
    read only = no
    create mask = 0600
    directory mask = 0700
```

The basic options shown in this example are explained as follows:

passdb backend This contains all the user and group account information. Acceptable values for a PDC are: `smbpasswd`, `tdbsam`, and `ldapsam`. The “*guest*” entry provides default accounts and is included by default, there is no need to add it explicitly.

Where use of backup Domain Controllers (BDCs) is intended, the only logical choice is to use LDAP so the `passdb` backend can be distributed. The `tdbsam` and `smbpasswd` files cannot effectively be distributed and therefore should not be used.

Domain Control Parameters The parameters `os level`, `preferred master`, `domain master`, `security`, `encrypt passwords`, and `domain logons` play a central role in assuring domain control and network logon support.

The *os level* must be set at or above a value of 32. A Domain Controller must be the Domain Master Browser, must be set in *user* mode security, must support Microsoft-compatible encrypted passwords, and must provide the network logon service (domain logons). Encrypted passwords must be enabled. For more details on how to do this, refer to Account Information Databases.

Environment Parameters The parameters *logon path*, *logon home*, *logon drive*, and *logon script* are environment support settings that help to facilitate client logon operations and that help to provide automated control facilities to ease network management overheads. Please refer to the man page information for these parameters.

NETLOGON Share The NETLOGON share plays a central role in domain logon and Domain Membership support. This share is provided on all Microsoft Domain Controllers. It is used to provide logon scripts, to store Group Policy files (NTConfig.POL), as well as to locate other common tools that may be needed for logon processing. This is an essential share on a Domain Controller.

PROFILE Share This share is used to store user desktop profiles. Each user must have a directory at the root of this share. This directory must be write-enabled for the user and must be globally read-enabled. Samba-3 has a VFS module called “*fake_permissions*” that may be installed on this share. This will allow a Samba administrator to make the directory read-only to everyone. Of course this is useful only after the profile has been properly created.

NOTE

The above parameters make for a full set of parameters that may define the server's mode of operation. The following *smb.conf* parameters are the essentials alone:



```
netbios name = BELERIAND  
workgroup = MIDEARTH  
domain logons = Yes  
domain master = Yes  
security = User
```

The additional parameters shown in the longer listing above just makes for a more complete explanation.

4.4 Samba ADS Domain Control

Samba-3 is not, and cannot act as, an Active Directory Server. It cannot truly function as an Active Directory Primary Domain Controller. The protocols for some of the functionality

of Active Directory Domain Controllers has been partially implemented on an experimental only basis. Please do not expect Samba-3 to support these protocols. Do not depend on any such functionality either now or in the future. The Samba Team may remove these experimental features or may change their behavior. This is mentioned for the benefit of those who have discovered secret capabilities in Samba-3 and who have asked when this functionality will be completed. The answer is maybe or maybe never!

To be sure, Samba-3 is designed to provide most of the functionality that Microsoft Windows NT4-style Domain Controllers have. Samba-3 does not have all the capabilities of Windows NT4, but it does have a number of features that Windows NT4 domain controllers do not have. In short, Samba-3 is not NT4 and it is not Windows Server 200x, it is not an Active Directory server. We hope this is plain and simple enough for all to understand.

4.5 Domain and Network Logon Configuration

The subject of Network or Domain Logons is discussed here because it forms an integral part of the essential functionality that is provided by a Domain Controller.

4.5.1 Domain Network Logon Service

All Domain Controllers must run the netlogon service (*domain logons* in Samba). One Domain Controller must be configured with `domain master = Yes` (the Primary Domain Controller); on all Backup Domain Controllers `domain master = No` must be set.

4.5.1.1 Example Configuration

Example 4.5.1. smb.conf for being a PDC

```
[global]
    domain logons = Yes
    domain master = (Yes on PDC, No on BDCs)

[netlogon]
    comment = Network Logon Service
    path = /var/lib/samba/netlogon
    guest ok = Yes
    browseable = No
```

4.5.1.2 The Special Case of MS Windows XP Home Edition

To be completely clear: If you want MS Windows XP Home Edition to integrate with your MS Windows NT4 or Active Directory Domain Security, understand it cannot be done. The only option is to purchase the upgrade from MS Windows XP Home Edition to MS Windows XP Professional.

NOTE



MS Windows XP Home Edition does not have the ability to join any type of Domain Security facility. Unlike MS Windows 9x/Me, MS Windows XP Home Edition also completely lacks the ability to log onto a network.

Now that this has been said, please do not ask the mailing list or email any of the Samba Team members with your questions asking how to make this work. It can't be done. If it can be done, then to do so would violate your software license agreement with Microsoft, and we recommend that you do not do that.

4.5.1.3 The Special Case of Windows 9x/Me

A domain and a workgroup are exactly the same in terms of network browsing. The difference is that a distributable authentication database is associated with a domain, for secure login access to a network. Also, different access rights can be granted to users if they successfully authenticate against a domain logon server. Samba-3 does this now in the same way as MS Windows NT/200x.

The SMB client logging on to a domain has an expectation that every other server in the domain should accept the same authentication information. Network browsing functionality of domains and workgroups is identical and is explained in this documentation under the browsing discussions. It should be noted that browsing is totally orthogonal to logon support.

Issues related to the single-logon network model are discussed in this section. Samba supports domain logons, network logon scripts and user profiles for MS Windows for workgroups and MS Windows 9X/ME clients, which are the focus of this section.

When an SMB client in a domain wishes to logon, it broadcasts requests for a logon server. The first one to reply gets the job, and validates its password using whatever mechanism the Samba administrator has installed. It is possible (but ill advised) to create a domain where the user database is not shared between servers, i.e., they are effectively workgroup servers advertising themselves as participating in a domain. This demonstrates how authentication is quite different from but closely involved with domains.

Using these features you can make your clients verify their logon via the Samba server; make clients run a batch file when they logon to the network and download their preferences, desktop and start menu.

MS Windows XP Home edition is not able to join a domain and does not permit the use of domain logons.

Before launching into the configuration instructions, it is worthwhile to look at how a Windows 9x/Me client performs a logon:

1. The client broadcasts (to the IP broadcast address of the subnet it is in) a NetLogon request. This is sent to the NetBIOS name DOMAIN<#1c> at the NetBIOS layer. The client chooses the first response it receives, which contains the NetBIOS name of the logon server to use in the format of \\SERVER.
2. The client connects to that server, logs on (does an SMBsesssetupX) and then connects to the IPC\$ share (using an SMBtconX).
3. The client does a NetWkstaUserLogon request, which retrieves the name of the user's logon script.
4. The client then connects to the NetLogon share and searches for said script. If it is found and can be read, it is retrieved and executed by the client. After this, the client disconnects from the NetLogon share.
5. The client sends a NetUserGetInfo request to the server to retrieve the user's home share, which is used to search for profiles. Since the response to the NetUserGetInfo request does not contain much more than the user's home share, profiles for Windows 9x clients must reside in the user home directory.
6. The client connects to the user's home share and searches for the user's profile. As it turns out, you can specify the user's home share as a share name and path. For example, \\server\fred\winprofile. If the profiles are found, they are implemented.
7. The client then disconnects from the user's home share and reconnects to the NetLogon share and looks for CONFIG.POL, the policies file. If this is found, it is read and implemented.

The main difference between a PDC and a Windows 9x/Me logon server configuration is:

- Password encryption is not required for a Windows 9x/Me logon server. But note that beginning with MS Windows 98 the default setting is that plain-text password support is disabled. It can be re-enabled with the registry changes that are documented in System and Account Policies.
- Windows 9x/Me clients do not require and do not use Machine Trust Accounts.

A Samba PDC will act as a Windows 9x/Me logon server; after all, it does provide the network logon services that MS Windows 9x/Me expect to find.

NOTE



Use of plain-text passwords is strongly discouraged. Where used they are easily detected using a sniffer tool to examine network traffic.

4.5.2 Security Mode and Master Browsers

There are a few comments to make in order to tie up some loose ends. There has been much debate over the issue of whether it is okay to configure Samba as a Domain Controller in security modes other than user. The only security mode that will not work due to technical reasons is share-mode security. Domain and server mode security are really just a variation on SMB User Level Security.

Actually, this issue is also closely tied to the debate on whether Samba must be the Domain Master Browser for its workgroup when operating as a DC. While it may technically be possible to configure a server as such (after all, browsing and domain logons are two distinctly different functions), it is not a good idea to do so. You should remember that the DC must register the DOMAIN<#1b> NetBIOS name. This is the name used by Windows clients to locate the DC. Windows clients do not distinguish between the DC and the DMB. A DMB is a Domain Master Browser — see Configuring WORKGROUP Browsing section. For this reason, it is wise to configure the Samba DC as the DMB.

Now back to the issue of configuring a Samba DC to use a mode other than security = user. If a Samba host is configured to use another SMB server or DC in order to validate user connection requests, it is a fact that some other machine on the network (the password server) knows more about the user than the Samba host. About 99% of the time, this other host is a Domain Controller. Now to operate in domain mode security, the workgroup parameter must be set to the name of the Windows NT domain (which already has a Domain Controller). If the domain does not already have a Domain Controller, you do not yet have a Domain.

Configuring a Samba box as a DC for a domain that already by definition has a PDC is asking for trouble. Therefore, you should always configure the Samba DC to be the DMB for its domain and set security = user. This is the only officially supported mode of operation.

4.6 Common Errors

4.6.1 “\$” Cannot Be Included in Machine Name

A machine account, typically stored in `/etc/passwd`, takes the form of the machine name with a “\$” appended. FreeBSD (and other BSD systems) will not create a user with a “\$” in the name.

The problem is only in the program used to make the entry. Once made, it works perfectly. Create a user without the “\$”. Then use **vipw** to edit the entry, adding the “\$”. Or create the whole entry with **vipw** if you like; make sure you use a unique user login ID.

NOTE



The machine account must have the exact name that the workstation has.

NOTE



The UNIX tool **vipw** is a common tool for directly editing the `/etc/passwd` file.

4.6.2 Joining Domain Fails Because of Existing Machine Account

“I get told, ‘You already have a connection to the Domain...’ or ‘Cannot join domain, the credentials supplied conflict with an existing set...’ when creating a Machine Trust Account.”

This happens if you try to create a Machine Trust Account from the machine itself and already have a connection (e.g., mapped drive) to a share (or IPC\$) on the Samba PDC. The following command will remove all network drive connections:

```
C:\> net use * /d
```

Further, if the machine is already a “*member of a workgroup*” that is the same name as the domain you are joining (bad idea) you will get this message. Change the workgroup name to something else, it does not matter what, reboot, and try again.

4.6.3 The System Cannot Log You On (C000019B)

“I joined the domain successfully but after upgrading to a newer version of the Samba code I get the message, ‘The system cannot log you on (C000019B), Please try again or consult your system administrator when attempting to logon.”

This occurs when the domain SID stored in the `secrets.tdb` database is changed. The most common cause of a change in domain SID is when the domain name and/or the server name (NetBIOS name) is changed. The only way to correct the problem is to restore the original domain SID or remove the domain client from the domain and rejoin. The domain SID may be reset using either the `net` or `rpcclient` utilities.

To reset or change the domain SID you can use the `net` command as follows:

```
root# net getlocalsid 'OLDNAME'  
root# net setlocalsid 'SID'
```

Workstation Machine Trust Accounts work only with the Domain (or network) SID. If this SID changes Domain Members (workstations) will not be able to log onto the domain. The original Domain SID can be recovered from the `secrets.tdb` file. The alternative is to visit each workstation to re-join it to the domain.

4.6.4 The Machine Trust Account Is Not Accessible

“When I try to join the domain I get the message, ‘The machine account for this computer either does not exist or is not accessible’. What’s wrong?”

This problem is caused by the PDC not having a suitable Machine Trust Account. If you are using the add machine script method to create accounts then this would indicate that it has not worked. Ensure the domain admin user system is working.

Alternately, if you are creating account entries manually then they have not been created correctly. Make sure that you have the entry correct for the Machine Trust Account in `smbpasswd` file on the Samba PDC. If you added the account using an editor rather than using the `smbpasswd` utility, make sure that the account name is the machine NetBIOS name with a “\$” appended to it (i.e., `computer_name$`). There must be an entry in both `/etc/passwd` and the `smbpasswd` file.

Some people have also reported that inconsistent subnet masks between the Samba server and the NT client can cause this problem. Make sure that these are consistent for both client and server.

4.6.5 Account Disabled

“When I attempt to login to a Samba Domain from a NT4/W200x workstation, I get a message about my account being disabled.”

Enable the user accounts with `smbpasswd -e username`. This is normally done as an account is created.

4.6.6 Domain Controller Unavailable

“Until a few minutes after Samba has started, clients get the error ‘Domain Controller Unavailable’”

A Domain Controller has to announce its role on the network. This usually takes a while. Be patient for up to fifteen minutes, then try again.

4.6.7 Cannot Log onto Domain Member Workstation After Joining Domain

After successfully joining the domain, user logons fail with one of two messages: one to the effect that the Domain Controller cannot be found; the other claims that the account does not exist in the domain or that the password is incorrect. This may be due to incompatible settings between the Windows client and the Samba-3 server for *schannel* (secure channel) settings or *smb signing* settings. Check your Samba settings for *client schannel*, *server schannel*, *client signing*, *server signing* by executing:

```
testparm -v | more
```

 and looking for the value of these parameters.

Also use the Microsoft Management Console — Local Security Settings. This tool is available from the Control Panel. The Policy settings are found in the Local Policies/Security Options area and are prefixed by *Secure Channel: ...*, and *Digitally sign*

It is important that these be set consistently with the Samba-3 server settings.

BACKUP DOMAIN CONTROL

Before you continue reading this section, please make sure that you are comfortable with configuring a Samba Domain Controller as described in Domain Control.

5.1 Features and Benefits

This is one of the most difficult chapters to summarize. It does not matter what we say here for someone will still draw conclusions and/or approach the Samba Team with expectations that are either not yet capable of being delivered, or that can be achieved far more effectively using a totally different approach. In the event that you should have a persistent concern that is not addressed in this book, please email John H. Terpstra <<mailto:jht@samba.org>> clearly setting out your requirements and/or question and we will do our best to provide a solution.

Samba-3 is capable of acting as a Backup Domain Controller (BDC) to another Samba Primary Domain Controller (PDC). A Samba-3 PDC can operate with an LDAP Account backend. The LDAP backend can be either a common master LDAP server, or a slave server. The use of a slave LDAP server has the benefit that when the master is down, clients may still be able to log onto the network. This effectively gives Samba a high degree of scalability and is an effective solution for large organizations. If you use an LDAP slave server for a PDC, you will need to ensure the master's continued availability - if the slave finds it's master down at the wrong time, you will have stability and operational problems.

While it is possible to run a Samba-3 BDC with non-LDAP backend, that backend must allow some form of 'two way' propagation, of changes from the BDC to the master. Only LDAP is capable of this at this stage.

The use of a non-LDAP backend SAM database is particularly problematic because Domain Member servers and workstations periodically change the Machine Trust Account password. The new password is then stored only locally. This means that in the absence of a centrally stored accounts database (such as that provided with an LDAP-based solution) if Samba-3 is running as a BDC, the BDC instance of the Domain Member trust account password will not reach the PDC (master) copy of the SAM. If the PDC SAM is then replicated to BDCs, this results in overwriting the SAM that contains the updated (changed) trust account password with resulting breakage of the domain trust.

Considering the number of comments and questions raised concerning how to configure a BDC, let's consider each possible option and look at the pros and cons for each possible solution. Following table lists possible design configurations for a PDC/BDC infrastructure.

Table 5.1. Domain Backend Account Distribution Options

PDC Backend	BDC Backend	Notes/Discussion
Master LDAP Server	Slave LDAP Server	The optimal solution that provides high integrity. The SAM will be replicated to a common master LDAP server.
Single Central LDAP Server	Single Central LDAP Server	A workable solution without fail-over ability. This is a usable solution, but not optimal.
tbsam	tbsam + net rpc vampire	Does not work with Samba-3.0.0; may be implemented in a later release. The downside of this solution is that an external process will control account database integrity. This solution may appeal to sites that wish to avoid the complexity of LDAP. The net rpc vampire is used to synchronize domain accounts from the PDC to the BDC.
tbsam	tbsam + rsync	Do not use this configuration. Does not work because the TDB files are live and data may not have been flushed to disk. Use rsync to synchronize the TDB database files from the PDC to the BDC.
smbpasswd file	smbpasswd file	Do not use this configuration. Not an elegant solution due to the delays in synchronization. Use rsync to synchronize the smbpasswd file from the PDC to the BDC. Can be made to work using a cron job to synchronize data from the PDC to the BDC.

5.2 Essential Background Information

A Domain Controller is a machine that is able to answer logon requests from network workstations. Microsoft LanManager and IBM LanServer were two early products that provided this capability. The technology has become known as the LanMan Netlogon service.

When MS Windows NT3.10 was first released, it supported a new style of Domain Control and with it a new form of the network logon service that has extended functionality. This service became known as the NT NetLogon Service. The nature of this service has changed with the evolution of MS Windows NT and today provides a complex array of services that are implemented over an intricate spectrum of technologies.

5.2.1 MS Windows NT4-style Domain Control

Whenever a user logs into a Windows NT4/200x/XP Professional Workstation, the workstation connects to a Domain Controller (authentication server) to validate that the username and password the user entered are valid. If the information entered does not match account information that has been stored in the Domain Control database (the SAM, or Security Account Manager database), a set of error codes is returned to the workstation that has made the authentication request.

When the username/password pair has been validated, the Domain Controller (authentication server) will respond with full enumeration of the account information that has been stored regarding that user in the User and Machine Accounts database for that Domain. This information contains a complete network access profile for the user but excludes any information that is particular to the user's desktop profile, or for that matter it excludes all desktop profiles for groups that the user may belong to. It does include password time limits, password uniqueness controls, network access time limits, account validity information, machine names from which the user may access the network, and much more. All this information was stored in the SAM in all versions of MS Windows NT (3.10, 3.50, 3.51, 4.0).

The account information (user and machine) on Domain Controllers is stored in two files, one containing the Security information and the other the SAM. These are stored in files by the same name in the %SystemRoot%\System32\config directory. This normally translates to the path C:\WinNT\System32\config. These are the files that are involved in replication of the SAM database where Backup Domain Controllers are present on the network.

There are two situations in which it is desirable to install Backup Domain Controllers:

- On the local network that the Primary Domain Controller is on, if there are many workstations and/or where the PDC is generally very busy. In this case the BDCs will pick up network logon requests and help to add robustness to network services.
- At each remote site, to reduce wide area network traffic and to add stability to remote network operations. The design of the network, the strategic placement of Backup Domain Controllers, together with an implementation that localizes as much of network to client interchange as possible will help to minimize wide area network bandwidth needs (and thus costs).

The inter-operation of a PDC and its BDCs in a true Windows NT4 environment is worth mentioning here. The PDC contains the master copy of the SAM. In the event that an administrator makes a change to the user account database while physically present on the local network that has the PDC, the change will likely be made directly to the PDC instance of the master copy of the SAM. In the event that this update may be performed in a branch office, the change will likely be stored in a delta file on the local BDC. The BDC will then send a trigger to the PDC to commence the process of SAM synchronization. The PDC will then request the delta from the BDC and apply it to the master SAM. The PDC will then contact all the BDCs in the Domain and trigger them to obtain the update and then apply that to their own copy of the SAM.

Samba-3 can not participate in true SAM replication and is therefore not able to employ precisely the same protocols used by MS Windows NT4. A Samba-3 BDC will not create

SAM update delta files. It will not inter-operate with a PDC (NT4 or Samba) to synchronize the SAM from delta files that are held by BDCs.

Samba-3 cannot function as a BDC to an MS Windows NT4 PDC, and Samba-3 can not function correctly as a PDC to an MS Windows NT4 BDC. Both Samba-3 and MS Windows NT4 can function as a BDC to its own type of PDC.

The BDC is said to hold a *read-only* of the SAM from which it is able to process network logon requests and authenticate users. The BDC can continue to provide this service, particularly while, for example, the wide area network link to the PDC is down. A BDC plays a very important role in both the maintenance of Domain Security as well as in network integrity.

In the event that the NT4 PDC should need to be taken out of service, or if it dies, one of the NT4 BDCs can be promoted to a PDC. If this happens while the original NT4 PDC is on line, it is automatically demoted to an NT4 BDC. This is an important aspect of Domain Controller management. The tool that is used to effect a promotion or a demotion is the Server Manager for Domains. It should be noted that Samba-3 BDCs can not be promoted in this manner because reconfiguration of Samba requires changes to the `smb.conf` file.

5.2.1.1 Example PDC Configuration

Beginning with Version 2.2, Samba officially supports domain logons for all current Windows clients, including Windows NT4, 2003 and XP Professional. For Samba to be enabled as a PDC, some parameters in the *[global]*-section of the `smb.conf` have to be set. Refer to following configuration for an example of the minimum required settings.

Example 5.2.1. Minimal `smb.conf` for a PDC in Use With a BDC LDAP Server on PDC.

```
workgroup = MIDEARTH
passdb backend = ldapsam://localhost:389
domain master = yes
domain logons = yes
```

Several other things like a *[homes]* and a *[netlogon]* share also need to be set along with settings for the profile path, the user's home drive, and so on. This is not covered in this chapter; for more information please refer to Domain Control.

5.2.2 LDAP Configuration Notes

When configuring a master and a slave LDAP server, it is advisable to use the master LDAP server for the PDC and slave LDAP servers for the BDCs. It is not essential to use slave LDAP servers, however, many administrators will want to do so in order to provide redundant services. Of course, one or more BDCs may use any slave LDAP server. Then again, it is entirely possible to use a single LDAP server for the entire network.

When configuring a master LDAP server that will have slave LDAP servers, do not forget to configure this in the `/etc/openldap/slapd.conf` file. It must be noted that the DN of a server certificate must use the CN attribute to name the server, and the CN must carry the servers' fully qualified domain name. Additional alias names and wildcards may be present

in the subjectAltName certificate extension. More details on server certificate names are in RFC2830.

It does not really fit within the scope of this document, but a working LDAP installation is basic to LDAP enabled Samba operation. When using an OpenLDAP server with Transport Layer Security (TLS), the machine name in `/etc/ssl/certs/slappd.pem` must be the same as in `/etc/openldap/slapd.conf`. The Red Hat Linux startup script creates the `slappd.pem` file with hostname `"localhost.localdomain."` It is impossible to access this LDAP server from a slave LDAP server (i.e., a Samba BDC) unless the certificate is recreated with a correct hostname.

Do not install a Samba PDC on a OpenLDAP slave server. Joining client machines to the domain will fail in this configuration because the change to the machine account in the LDAP tree must take place on the master LDAP server. This is not replicated rapidly enough to the slave server that the PDC queries. It therefore gives an error message on the client machine about not being able to set up account credentials. The machine account is created on the LDAP server but the password fields will be empty.

Possible PDC/BDC plus LDAP configurations include:

- PDC+BDC -> One Central LDAP Server.
- PDC -> LDAP master server, BDC -> LDAP slave server.
- PDC -> LDAP master, with secondary slave LDAP server.
BDC -> LDAP master, with secondary slave LDAP server.
- PDC -> LDAP master, with secondary slave LDAP server.
BDC -> LDAP slave server, with secondary master LDAP server.

In order to have a fall-back configuration (secondary) LDAP server one would specify the secondary LDAP server in the `smb.conf` file as shown in following example.

Example 5.2.2. Multiple LDAP Servers in `smb.conf`

```
...  
    passdb backend =  
    ldapsam:"ldap://master.kenya.org ldap://slave.kenya.org"  
...
```

5.2.3 Active Directory Domain Control

As of the release of MS Windows 2000 and Active Directory, this information is now stored in a directory that can be replicated and for which partial or full administrative control can be delegated. Samba-3 is not able to be a Domain Controller within an Active Directory tree, and it cannot be an Active Directory server. This means that Samba-3 also cannot act as a Backup Domain Controller to an Active Directory Domain Controller.

5.2.4 What Qualifies a Domain Controller on the Network?

Every machine that is a Domain Controller for the domain MIDEARTH has to register the NetBIOS group name MIDEARTH<#1c> with the WINS server and/or by broadcast on the local network. The PDC also registers the unique NetBIOS name MIDEARTH<#1b> with the WINS server. The name type <#1b> name is normally reserved for the Domain Master Browser, a role that has nothing to do with anything related to authentication, but the Microsoft Domain implementation requires the Domain Master Browser to be on the same machine as the PDC.

Where a WINS server is not used, broadcast name registrations alone must suffice. Refer to Network Browsing: Discussion for more information regarding TCP/IP network protocols and how SMB/CIFS names are handled.

5.2.5 How does a Workstation find its Domain Controller?

There are two different mechanisms to locate a domain controller, one method is used when NetBIOS over TCP/IP is enabled and the other when it has been disabled in the TCP/IP network configuration.

Where NetBIOS over TCP/IP is disabled, all name resolution involves the use of DNS, broadcast messaging over UDP, as well as Active Directory communication technologies. In this type of environment all machines require appropriate DNS entries. More information may be found in DNS and Active Directory.

5.2.5.1 NetBIOS Over TCP/IP Enabled

An MS Windows NT4/200x/XP Professional workstation in the domain MIDEARTH that wants a local user to be authenticated has to find the Domain Controller for MIDEARTH. It does this by doing a NetBIOS name query for the group name MIDEARTH<#1c>. It assumes that each of the machines it gets back from the queries is a Domain Controller and can answer logon requests. To not open security holes, both the workstation and the selected Domain Controller authenticate each other. After that the workstation sends the user's credentials (name and password) to the local Domain Controller for validation.

5.2.5.2 NetBIOS Over TCP/IP Disabled

An MS Windows NT4/200x/XP Professional workstation in the realm `kenya.org` that has a need to affect user logon authentication will locate the Domain Controller by re-querying DNS servers for the `_ldap._tcp.pdc._msdcs.kenya.org` record. More information regarding this subject may be found in DNS and Active Directory.

5.3 Backup Domain Controller Configuration

The creation of a BDC requires some steps to prepare the Samba server before `smbd` is executed for the first time. These steps are outlined as follows:

- The domain SID has to be the same on the PDC and the BDC. In Samba versions pre-2.2.5, the domain SID was stored in the file `private/MACHINE.SID`. The domain SID is now stored in the file `private/secrets.tdb`. This file is unique to each server and can not be copied from a PDC to a BDC, the BDC will generate a new SID at start-up. It will over-write the PDC domain SID with the newly created BDC SID. There is a procedure that will allow the BDC to acquire the Domain SID. This is described here.

To retrieve the domain SID from the PDC or an existing BDC and store it in the `secrets.tdb`, execute:

```
root# net rpc getsid
```

- Specification of the ldap admin dn is obligatory. This also requires the LDAP administration password to be set in the `secrets.tdb` using the `smbpasswd -w mysecret`.
- Either ldap suffix or ldap idmap suffix must be specified in the `smb.conf` file.
- The UNIX user database has to be synchronized from the PDC to the BDC. This means that both the `/etc/passwd` and `/etc/group` have to be replicated from the PDC to the BDC. This can be done manually whenever changes are made. Alternately, the PDC is set up as an NIS master server and the BDC as an NIS slave server. To set up the BDC as a mere NIS client would not be enough, as the BDC would not be able to access its user database in case of a PDC failure. NIS is by no means the only method to synchronize passwords. An LDAP solution would also work.
- The Samba password database must be replicated from the PDC to the BDC. Although it is possible to synchronize the `smbpasswd` file with `rsync` and `ssh`, this method is broken and flawed, and is therefore not recommended. A better solution is to set up slave LDAP servers for each BDC and a master LDAP server for the PDC.
- The netlogon share has to be replicated from the PDC to the BDC. This can be done manually whenever login scripts are changed, or it can be done automatically using a `cron` job that will replicate the directory structure in this share using a tool like `rsync`.

5.3.1 Example Configuration

Finally, the BDC has to be found by the workstations. This can be done by setting Samba as shown in the next example.

Example 5.3.1. Minimal setup for being a BDC

```
workgroup = MIDEARTH
passdb backend = ldapsam:ldap://slave-ldap.kenya.org
domain master = no
domain logons = yes
idmap backend = ldap:ldap://slave-ldap.kenya.org
```

In the *[global]*-section of the `smb.conf` of the BDC. This makes the BDC only register the name `MIDEARTH<#1c>` with the WINS server. This is no problem as the name `MIDEARTH<#1c>` is a NetBIOS group name that is meant to be registered by more than one machine. The parameter `domain master = no` forces the BDC not to register `MIDEARTH<#1b>` which as a unique NetBIOS name is reserved for the Primary Domain Controller.

The *idmap backend* will redirect the `winbindd` utility to use the LDAP database to resolve all UIDs and GIDs for UNIX accounts.

NOTE



Samba-3 has introduced a new ID mapping facility. One of the features of this facility is that it allows greater flexibility in how user and group IDs are handled in respect to NT Domain User and Group SIDs. One of the new facilities provides for explicitly ensuring that UNIX/Linux UID and GID values will be consistent on the PDC, all BDCs and all Domain Member servers. The parameter that controls this is called *idmap backend*. Please refer to the man page for `smb.conf` for more information regarding its behavior.

The use of the `idmap backend = ldap:ldap://master.quenya.org` option on a BDC only make sense where `ldapsam` is used on a PDC. The purpose for an LDAP based `idmap backend` is also to allow a domain-member (without its own `passdb backend`) to use `winbindd` to resolve Windows network users and groups to common UID/GIDs. In other words, this option is generally intended for use on BDCs and on Domain Member servers.

5.4 Common Errors

As this is a rather new area for Samba, there are not many examples that we may refer to. Updates will be published as they become available and may be found in later Samba releases or from the Samba web site. <http://samba.org>

5.4.1 Machine Accounts Keep Expiring

This problem will occur when the `passdb (SAM)` files are copied from a central server but the local Backup Domain Controller is acting as a PDC. This results in the application of Local Machine Trust Account password updates to the local SAM. Such updates are not copied back to the central server. The newer machine account password is then over written when the SAM is re-copied from the PDC. The result is that the Domain Member machine on start up will find that its passwords do not match the one now in the database and since the startup security check will now fail, this machine will not allow logon attempts to proceed and the account expiry error will be reported.

The solution is to use a more robust passdb backend, such as the ldapsam backend, setting up a slave LDAP server for each BDC, and a master LDAP server for the PDC.

5.4.2 Can Samba Be a Backup Domain Controller to an NT4 PDC?

No. The native NT4 SAM replication protocols have not yet been fully implemented.

Can I get the benefits of a BDC with Samba? Yes, but only to a Samba PDC. The main reason for implementing a BDC is availability. If the PDC is a Samba machine, a second Samba machine can be set up to service logon requests whenever the PDC is down.

5.4.3 How Do I Replicate the smbpasswd File?

Replication of the smbpasswd file is sensitive. It has to be done whenever changes to the SAM are made. Every user's password change is done in the smbpasswd file and has to be replicated to the BDC. So replicating the smbpasswd file very often is necessary.

As the smbpasswd file contains plain text password equivalents, it must not be sent unencrypted over the wire. The best way to set up smbpasswd replication from the PDC to the BDC is to use the utility rsync. rsync can use ssh as a transport. **ssh** itself can be set up to accept *only* **rsync** transfer without requiring the user to type a password.

As said a few times before, use of this method is broken and flawed. Machine trust accounts will go out of sync, resulting in a broken domain. This method is *not* recommended. Try using LDAP instead.

5.4.4 Can I Do This All with LDAP?

The simple answer is yes. Samba's pdb_ldap code supports binding to a replica LDAP server, and will also follow referrals and re-bind to the master if it ever needs to make a modification to the database. (Normally BDCs are read only, so this will not occur often).

DOMAIN MEMBERSHIP

Domain Membership is a subject of vital concern. Samba must be able to participate as a member server in a Microsoft Domain Security context, and Samba must be capable of providing Domain machine member trust accounts, otherwise it would not be able to offer a viable option for many users.

This chapter covers background information pertaining to Domain Membership, the Samba configuration for it, and MS Windows client procedures for joining a domain. Why is this necessary? Because both are areas in which there exists within the current MS Windows networking world and particularly in the UNIX/Linux networking and administration world, a considerable level of misinformation, incorrect understanding and a lack of knowledge. Hopefully this chapter will fill the voids.

6.1 Features and Benefits

MS Windows workstations and servers that want to participate in Domain Security need to be made Domain Members. Participating in Domain Security is often called *Single Sign On* or SSO for short. This chapter describes the process that must be followed to make a workstation (or another server — be it an MS Windows NT4 / 200x server) or a Samba server a member of an MS Windows Domain Security context.

Samba-3 can join an MS Windows NT4-style domain as a native member server, an MS Windows Active Directory Domain as a native member server, or a Samba Domain Control network. Domain Membership has many advantages:

- MS Windows workstation users get the benefit of SSO.
- Domain user access rights and file ownership/access controls can be set from the single Domain Security Account Manager (SAM) database (works with Domain Member servers as well as with MS Windows workstations that are Domain Members).
- Only MS Windows NT4/200x/XP Professional workstations that are Domain Members can use network logon facilities.
- Domain Member workstations can be better controlled through the use of Policy files (NTConfig.POL) and Desktop Profiles.

- Through the use of logon scripts, users can be given transparent access to network applications that run off application servers.
- Network administrators gain better application and user access management abilities because there is no need to maintain user accounts on any network client or server, other than the central Domain database (either NT4/Samba SAM style Domain, NT4 Domain that is backend-ed with an LDAP directory, or via an Active Directory infrastructure).

6.2 MS Windows Workstation/Server Machine Trust Accounts

A Machine Trust Account is an account that is used to authenticate a client machine (rather than a user) to the Domain Controller server. In Windows terminology, this is known as a “*Computer Account*.” The purpose of the machine account is to prevent a rogue user and Domain Controller from colluding to gain access to a domain member workstation.

The password of a Machine Trust Account acts as the shared secret for secure communication with the Domain Controller. This is a security feature to prevent an unauthorized machine with the same NetBIOS name from joining the domain and gaining access to domain user/group accounts. Windows NT/200x/XP Professional clients use machine trust accounts, but Windows 9x/Me/XP Home clients do not. Hence, a Windows 9x/Me/XP Home client is never a true member of a Domain because it does not possess a Machine Trust Account, and, thus, has no shared secret with the Domain Controller.

A Windows NT4 PDC stores each Machine Trust Account in the Windows Registry. The introduction of MS Windows 2000 saw the introduction of Active Directory, the new repository for Machine Trust Accounts. A Samba PDC, however, stores each Machine Trust Account in two parts, as follows:

- A Domain Security Account (stored in the `passdb` backend that has been configured in the `smb.conf` file. The precise nature of the account information that is stored depends on the type of backend database that has been chosen.

The older format of this data is the `smbpasswd` database that contains the UNIX login ID, the UNIX user identifier (UID), and the LanMan and NT encrypted passwords. There is also some other information in this file that we do not need to concern ourselves with here.

The two newer database types are called `ldapsam`, and `tdbsam`. Both store considerably more data than the older `smbpasswd` file did. The extra information enables new user account controls to be implemented.

- A corresponding UNIX account, typically stored in `/etc/passwd`. Work is in progress to allow a simplified mode of operation that does not require UNIX user accounts, but this may not be a feature of the early releases of Samba-3.

There are three ways to create Machine Trust Accounts:

- Manual creation from the UNIX/Linux command line. Here, both the Samba and corresponding UNIX account are created by hand.

- Using the MS Windows NT4 Server Manager, either from an NT4 Domain Member server, or using the Nexus toolkit available from the Microsoft Web site. This tool can be run from any MS Windows machine as long as the user is logged on as the administrator account.
- “*On-the-fly*” creation. The Samba Machine Trust Account is automatically created by Samba at the time the client is joined to the domain. (For security, this is the recommended method.) The corresponding UNIX account may be created automatically or manually.

6.2.1 Manual Creation of Machine Trust Accounts

The first step in manually creating a Machine Trust Account is to manually create the corresponding UNIX account in `/etc/passwd`. This can be done using `vipw` or another “*add user*” command that is normally used to create new UNIX accounts. The following is an example for a Linux-based Samba server:

```
root# /usr/sbin/useradd -g machines -d /dev/null -c "machine nickname" \
    -s /bin/false machine_name$

root# passwd -l machine_name$
```

In the example above there is an existing system group “*machines*” which is used as the primary group for all machine accounts. In the following examples the “*machines*” group has numeric GID equal 100.

On *BSD systems, this can be done using the `chpass` utility:

```
root# chpass -a \
'machine_name$:*:101:100::0:0:Windows machine_name:/dev/null:/sbin/nologin'
```

The `/etc/passwd` entry will list the machine name with a “*\$*” appended, will not have a password, will have a null shell and no home directory. For example, a machine named “*dobby*” would have an `/etc/passwd` entry like this:

```
dobby$:x:505:100:machine_nickname:/dev/null:/bin/false
```

Above, *machine_nickname* can be any descriptive name for the client, i.e., BasementComputer. *machine_name* absolutely must be the NetBIOS name of the client to be joined to the domain. The “*\$*” must be appended to the NetBIOS name of the client or Samba will not recognize this as a Machine Trust Account.

Now that the corresponding UNIX account has been created, the next step is to create the Samba account for the client containing the well-known initial Machine Trust Account password. This can be done using the `smbpasswd` command as shown here:

```
root# smbpasswd -a -m machine_name
```

where *machine_name* is the machine's NetBIOS name. The RID of the new machine account is generated from the UID of the corresponding UNIX account.

JOIN THE CLIENT TO THE DOMAIN IMMEDIATELY

Manually creating a Machine Trust Account using this method is the equivalent of creating a Machine Trust Account on a Windows NT PDC using the Server Manager. From the time at which the account is created to the time the client joins the domain and changes the password, your domain is vulnerable to an intruder joining your domain using a machine with the same NetBIOS name. A PDC inherently trusts members of the domain and will serve out a large degree of user information to such clients. You have been warned!

6.2.2 Managing Domain Machine Accounts using NT4 Server Manager

A working add machine script is essential for machine trust accounts to be automatically created. This applies no matter whether one uses automatic account creation, or if one wishes to use the NT4 Domain Server Manager.

If the machine from which you are trying to manage the domain is an MS Windows NT4 workstation or MS Windows 200x/XP Professional, the tool of choice is the package called **SRVTOOLS.EXE**. When executed in the target directory it will unpack **SrvMgr.exe** and **UsrMgr.exe** (both are domain management tools for MS Windows NT4 workstation).

If your workstation is a Microsoft Windows 9x/Me family product you should download the **Nexus.exe** package from the Microsoft web site. When executed from the target directory this will unpack the same tools but for use on this platform.

Further information about these tools may be obtained from the following locations:

<<http://support.microsoft.com/default.aspx?scid=kb;en-us;173673>>

<<http://support.microsoft.com/default.aspx?scid=kb;en-us;172540>>

Launch the **srvmgr.exe** (Server Manager for Domains) and follow these steps: Server Manager Account Machine Account Management

1. From the menu select **Computer**.
2. Click **Select Domain**.
3. Click the name of the domain you wish to administer in the **Select Domain** panel and then click **OK**.
4. Again from the menu select **Computer**.

5. Select **Add to Domain**.
6. In the dialog box, click the radio button to **Add NT Workstation of Server**, then enter the machine name in the field provided, and click the **Add** button.

6.2.3 On-the-Fly Creation of Machine Trust Accounts

The second (and recommended) way of creating Machine Trust Accounts is simply to allow the Samba server to create them as needed when the client is joined to the domain.

Since each Samba Machine Trust Account requires a corresponding UNIX account, a method for automatically creating the UNIX account is usually supplied; this requires configuration of the add machine script option in `smb.conf`. This method is not required, however, corresponding UNIX accounts may also be created manually.

Here is an example for a Red Hat Linux system.

```
[global]
# <...remainder of parameters...>
    add machine script = /usr/sbin/useradd -d /dev/null -g 100 \
-s /bin/false -M %u
```

6.2.4 Making an MS Windows Workstation or Server a Domain Member

The procedure for making an MS Windows workstation or server a member of the domain varies with the version of Windows.

6.2.4.1 Windows 200x/XP Professional Client

When the user elects to make the client a Domain Member, Windows 200x prompts for an account and password that has privileges to create machine accounts in the domain. A Samba Administrator Account (i.e., a Samba account that has `root` privileges on the Samba server) must be entered here; the operation will fail if an ordinary user account is given.

For security reasons, the password for this Administrator Account should be set to a password that is other than that used for the root user in `/etc/passwd`.

The name of the account that is used to create Domain Member machine accounts can be anything the network administrator may choose. If it is other than `root` then this is easily mapped to `root` in the file named in the `smb.conf` parameter `username map = /etc/samba/smbusers`.

The session key of the Samba Administrator Account acts as an encryption key for setting the password of the machine trust account. The Machine Trust Account will be created on-the-fly, or updated if it already exists.

6.2.4.2 Windows NT4 Client

If the Machine Trust Account was created manually, on the Identification Changes menu enter the domain name, but do not check the box **Create a Computer Account in the Domain**. In this case, the existing Machine Trust Account is used to join the machine to the domain.

If the Machine Trust Account is to be created on-the-fly, on the Identification Changes menu enter the domain name and check the box **Create a Computer Account in the Domain**. In this case, joining the domain proceeds as above for Windows 2000 (i.e., you must supply a Samba Administrator Account when prompted).

6.2.4.3 Samba Client

Joining a Samba client to a domain is documented in Domain Member Server.

6.3 Domain Member Server

This mode of server operation involves the Samba machine being made a member of a domain security context. This means by definition that all user authentication will be done from a centrally defined authentication regime. The authentication regime may come from an NT3/4-style (old domain technology) server, or it may be provided from an Active Directory server (ADS) running on MS Windows 2000 or later.

Of course it should be clear that the authentication backend itself could be from any distributed directory architecture server that is supported by Samba. This can be LDAP (from OpenLDAP), or Sun's iPlanet, or NetWare Directory Server, and so on.

NOTE



When Samba is configured to use an LDAP, or other identity management and/or directory service, it is Samba that continues to perform user and machine authentication. It should be noted that the LDAP server does not perform authentication handling in place of what Samba is designed to do.

Please refer to Domain Control, for more information regarding how to create a domain machine account for a Domain Member server as well as for information on how to enable the Samba Domain Member machine to join the domain and be fully trusted by it.

6.3.1 Joining an NT4-type Domain with Samba-3

Next table lists names that have been used in the remainder of this chapter.

First, you must edit your `smb.conf` file to tell Samba it should now use domain security.

Table 6.1. Assumptions

NetBIOS name:	SERV1
Windows 200x/NT domain name:	MIDEARTH
Domain's PDC NetBIOS name:	DOMPDC
Domain's BDC NetBIOS names:	DOMBDC1 and DOMBDC2

Change (or add) your security line in the [global] section of your `smb.conf` to read:

```
security = domain
```

Next change the workgroup line in the [global] section to read:

```
workgroup = MIDEARTH
```

This is the name of the domain we are joining.

You must also have the parameter `encrypt passwords` set to `yes` in order for your users to authenticate to the NT PDC. This is the default setting if this parameter is not specified. There is no need to specify this parameter, but if it is specified in the `smb.conf` file, it must be set to `Yes`.

Finally, add (or modify) a password server line in the [global] section to read:

```
password server = DOMPDC DOMBDC1 DOMBDC2
```

These are the primary and backup Domain Controllers Samba will attempt to contact in order to authenticate users. Samba will try to contact each of these servers in order, so you may want to rearrange this list in order to spread out the authentication load among Domain Controllers.

Alternately, if you want `smbd` to automatically determine the list of Domain Controllers to use for authentication, you may set this line to be:

```
password server = *
```

This method allows Samba to use exactly the same mechanism that NT does. The method either uses broadcast-based name resolution, performs a WINS database lookup in order to find a Domain Controller against which to authenticate, or locates the Domain Controller using DNS name resolution.

To join the domain, run this command:

```
root# net join -S DOMPDC -UAdministrator%password
```

If the `-S DOMPDC` argument is not given, the domain name will be obtained from `smb.conf`.

The machine is joining the domain `DOM`, and the PDC for that domain (the only machine that has write access to the domain SAM database) is `DOMPDC`, therefore use the `-S` option. The `Administrator%password` is the login name and password for an account that has the necessary privilege to add machines to the domain. If this is successful, you will

see the message in your terminal window the text shown below. Where the older NT4 style domain architecture is used:

```
Joined domain DOM.
```

Where Active Directory is used:

```
Joined SERV1 to realm MYREALM.
```

Refer to the **net** man page for further information.

This process joins the server to the domain without having to create the machine trust account on the PDC beforehand.

This command goes through the machine account password change protocol, then writes the new (random) machine account password for this Samba server into a file in the same directory in which a smbpasswd file would be normally stored:

```
/usr/local/samba/private/secrets.tdb  
or  
/etc/samba/secrets.tdb.
```

This file is created and owned by root and is not readable by any other user. It is the key to the Domain-level security for your system, and should be treated as carefully as a shadow password file.

Finally, restart your Samba daemons and get ready for clients to begin using domain security. The way you can restart your Samba daemons depends on your distribution, but in most cases the following will suffice:

```
root# /etc/init.d/samba restart
```

6.3.2 Why Is This Better Than `security = server`?

Currently, domain security in Samba does not free you from having to create local UNIX users to represent the users attaching to your server. This means that if Domain user `DOM\fred` attaches to your Domain Security Samba server, there needs to be a local UNIX user `fred` to represent that user in the UNIX file system. This is similar to the older Samba security mode `security = server`, where Samba would pass through the authentication request to a Windows NT server in the same way as a Windows 95 or Windows 98 server would.

Please refer to Winbind: Use of Domain Accounts chapter, for information on a system to automatically assign UNIX UIDs and GIDs to Windows NT Domain users and groups.

The advantage to Domain-level security is that the authentication in Domain-level security is passed down the authenticated RPC channel in exactly the same way that an NT server would do it. This means Samba servers now participate in domain trust relationships in exactly the same way NT servers do (i.e., you can add Samba servers into a resource domain and have the authentication passed on from a resource domain PDC to an account domain PDC).

In addition, with `security = server`, every Samba daemon on a server has to keep a connection open to the authenticating server for as long as that daemon lasts. This can drain the connection resources on a Microsoft NT server and cause it to run out of available connections. With `security = domain`, however, the Samba daemons connect to the PDC/BDC only for as long as is necessary to authenticate the user and then drop the connection, thus conserving PDC connection resources.

And finally, acting in the same manner as an NT server authenticating to a PDC means that as part of the authentication reply, the Samba server gets the user identification information such as the user SID, the list of NT groups the user belongs to, and so on.

NOTE



Much of the text of this document was first published in the Web magazine LinuxWorld <<http://www.linuxworld.com>> as the article <<http://www.linuxworld.com/linuxworld/lw-1998-10/lw-10-samba.html>> *Doing the NIS/NT Samba*.

6.4 Samba ADS Domain Membership

This is a rough guide to setting up Samba-3 with Kerberos authentication against a Windows 200x KDC. A familiarity with Kerberos is assumed.

6.4.1 Configure `smb.conf`

You must use at least the following three options in `smb.conf`:

```
realm = your.kerberos.REALM
security = ADS
# The following parameter need only be specified if present.
# The default setting is not present is Yes.
encrypt passwords = yes
```

In case samba cannot correctly identify the appropriate ADS server using the realm name, use the password server option in `smb.conf`: *password server = your.kerberos.server*

NOTE



You do *not* need a `smbpasswd` file, and older clients will be authenticated as if `security = domain`, although it will not do any harm and allows you to have local users not in the domain.

6.4.2 Configure `/etc/krb5.conf`

With both MIT and Heimdal Kerberos, it is unnecessary to configure the `/etc/krb5.conf`, and it may be detrimental.

Microsoft Active Directory servers automatically create SRV records in the DNS zone `.kerberos.REALM.NAME` for each KDC in the realm. This is part of the installation and configuration process used to create an Active Directory Domain.

MIT's, as well as Heimdal's, recent KRB5 libraries default to checking for SRV records, so they will automatically find the KDCs. In addition, `krb5.conf` only allows specifying a single KDC, even there if there may be more than one. Using the DNS lookup allows the KRB5 libraries to use whichever KDCs are available.

When manually configuring `krb5.conf`, the minimal configuration is:

```
[libdefaults]
    default_realm = YOUR.KERBEROS.REALM

[realms]
    YOUR.KERBEROS.REALM = {
        kdc = your.kerberos.server
    }

[domain_realms]
    .kerberos.server = YOUR.KERBEROS.REALM
```

When using Heimdal versions before 0.6 use the following configuration settings:

```
[libdefaults]
    default_realm          = YOUR.KERBEROS.REALM
    default_etypes         = des-cbc-crc des-cbc-md5
    default_etypes_des     = des-cbc-crc des-cbc-md5

[realms]
    YOUR.KERBEROS.REALM = {
        kdc = your.kerberos.server
    }
```

```
[domain_realms]
    .kerberos.server = YOUR.KERBEROS.REALM
```

Test your config by doing a `kinit USERNAME@REALM` and making sure that your password is accepted by the Win2000 KDC.

With Heimdal versions earlier than 0.6.x you only can use newly created accounts in ADS or accounts that have had the password changed once after migration, or in case of `Administrator` after installation. At the moment, a Windows 2003 KDC can only be used with a Heimdal releases later than 0.6 (and no default etypes in `krb5.conf`). Unfortunately this whole area is still in a state of flux.

NOTE



The realm must be in uppercase or you will get “*Cannot find KDC for requested realm while getting initial credentials*” error (Kerberos is case-sensitive!).

NOTE



Time between the two servers must be synchronized. You will get a “*kinit(v5): Clock skew too great while getting initial credentials*” if the time difference is more than five minutes.

Clock skew limits are configurable in the Kerberos protocols. The default setting is five minutes.

You also must ensure that you can do a reverse DNS lookup on the IP address of your KDC. Also, the name that this reverse lookup maps to must either be the NetBIOS name of the KDC (i.e., the hostname with no domain attached) or it can alternately be the NetBIOS name followed by the realm.

The easiest way to ensure you get this right is to add a `/etc/hosts` entry mapping the IP address of your KDC to its NetBIOS name. If you do not get this correct then you will get a local error when you try to join the realm.

If all you want is Kerberos support in `smbclient` then you can skip directly to Testing with `smbclient` now. Create the Computer Account and Testing Server Setup are needed only if you want Kerberos support for `smbd` and `winbindd`.

6.4.3 Create the Computer Account

As a user who has write permission on the Samba private directory (usually `root`), run:

```
root# net ads join -U Administrator%password
```

When making a Windows client a member of an ADS domain within a complex organization, you may want to create the machine account within a particular organizational unit. Samba-3 permits this to be done using the following syntax:

```
root# kinit Administrator@your.kerberos.REALM
root# net ads join "organizational_unit"
```

For example, you may want to create the machine account in a container called “*Servers*” under the organizational directory “*Computers\BusinessUnit\Department*” like this:

```
root# net ads join "Computers\BusinessUnit\Department\Servers"
```

6.4.3.1 Possible Errors

ADS support not compiled in Samba must be reconfigured (remove `config.cache`) and recompiled (`make clean all install`) after the Kerberos libraries and headers files are installed.

net ads join prompts for user name You need to login to the domain using `kinit USERNAME@REALM`. `USERNAME` must be a user who has rights to add a machine to the domain.

Unsupported encryption/or checksum types Make sure that the `/etc/krb5.conf` is correctly configured for the type and version of Kerberos installed on the system.

6.4.4 Testing Server Setup

If the join was successful, you will see a new computer account with the NetBIOS name of your Samba server in Active Directory (in the “*Computers*” folder under Users and Computers).

On a Windows 2000 client, try `net use * \\server\share`. You should be logged in with Kerberos without needing to know a password. If this fails then run `klist tickets`. Did you get a ticket for the server? Does it have an encryption type of DES-CBC-MD5?

NOTE



Samba can use both DES-CBC-MD5 encryption as well as ARCFOUR-HMAC-MD5 encoding.

6.4.5 Testing with smbclient

On your Samba server try to login to a Win2000 server or your Samba server using `smbclient` and Kerberos. Use `smbclient` as usual, but specify the `-k` option to choose Kerberos authentication.

6.4.6 Notes

You must change administrator password at least once after DC install, to create the right encryption types.

Windows 200x does not seem to create the `_kerberos._udp` and `_ldap._tcp` in the default DNS setup. Perhaps this will be fixed later in service packs.

6.5 Sharing User ID Mappings between Samba Domain Members

Samba maps UNIX users and groups (identified by UIDs and GIDs) to Windows users and groups (identified by SIDs). These mappings are done by the *idmap* subsystem of Samba.

In some cases it is useful to share these mappings between Samba Domain Members, so *name->id* mapping is identical on all machines. This may be needed in particular when sharing files over both CIFS and NFS.

To use the *LDAP ldap idmap suffix*, set:

```
ldap idmap suffix = ou=Idmap,dc=quenya,dc=org
```

See the `smb.conf` man page entry for the `ldap idmap suffix` parameter for further information.

Do not forget to specify also the `ldap admin dn` and to make certain to set the LDAP administrative password into the `secrets.tdb` using:

```
root# smbpasswd -w ldap-admin-password
```

6.6 Common Errors

In the process of adding/deleting/re-adding Domain Member machine accounts, there are many traps for the unwary player and many “*little*” things that can go wrong. It is particularly interesting how often subscribers on the Samba mailing list have concluded after repeated failed attempts to add a machine account that it is necessary to “*re-install*” MS Windows on the machine. In truth, it is seldom necessary to reinstall because of this type of problem. The real solution is often quite simple and with an understanding of how MS Windows networking functions, it is easy to overcome.

6.6.1 Cannot Add Machine Back to Domain

“A Windows workstation was re-installed. The original domain machine account was deleted and added immediately. The workstation will not join the domain if I use the same machine name. Attempts to add the machine fail with a message that the machine already exists on the network — I know it does not. Why is this failing?”

The original name is still in the NetBIOS name cache and must expire after machine account deletion before adding that same name as a Domain Member again. The best advice is to delete the old account and then add the machine with a new name.

6.6.2 Adding Machine to Domain Fails

“Adding a Windows 200x or XP Professional machine to the Samba PDC Domain fails with a message that, ‘The machine could not be added at this time, there is a network problem. Please try again later.’ Why?”

You should check that there is an add machine script in your `smb.conf` file. If there is not, please add one that is appropriate for your OS platform. If a script has been defined, you will need to debug its operation. Increase the log level in the `smb.conf` file to level 10, then try to rejoin the domain. Check the logs to see which operation is failing.

Possible causes include:

- The script does not actually exist, or could not be located in the path specified.

Corrective action: Fix it. Make sure when run manually that the script will add both the UNIX system account and the Samba SAM account.

- The machine could not be added to the UNIX system accounts file `/etc/passwd`.

Corrective action: Check that the machine name is a legal UNIX system account name. If the UNIX utility `useradd` is called, then make sure that the machine name you are trying to add can be added using this tool. `Useradd` on some systems will not allow any upper case characters nor will it allow spaces in the name.

The add machine script does not create the machine account in the Samba backend database, it is there only to create a UNIX system account to which the Samba backend database account can be mapped.

6.6.3 I Can't Join a Windows 2003 PDC

Windows 2003 requires SMB signing. Client side SMB signing has been implemented in Samba-3.0. Set `client use spnego = yes` when communicating with a Windows 2003 server.

STAND-ALONE SERVERS

Stand-alone Servers are independent of Domain Controllers on the network. They are not Domain Members and function more like workgroup servers. In many cases a Stand-alone Server is configured with a minimum of security control with the intent that all data served will be readily accessible to all users.

7.1 Features and Benefits

Stand-alone Servers can be as secure or as insecure as needs dictate. They can have simple or complex configurations. Above all, despite the hoopla about Domain Security they remain a common installation.

If all that is needed is a server for read-only files, or for printers alone, it may not make sense to effect a complex installation. For example: A drafting office needs to store old drawings and reference standards. No-one can write files to the server as it is legislatively important that all documents remain unaltered. A share mode read-only Stand-alone Server is an ideal solution.

Another situation that warrants simplicity is an office that has many printers that are queued off a single central server. Everyone needs to be able to print to the printers, there is no need to effect any access controls and no files will be served from the print server. Again, a share mode Stand-alone Server makes a great solution.

7.2 Background

The term *Stand-alone Server* means that it will provide local authentication and access control for all resources that are available from it. In general this means that there will be a local user database. In more technical terms, it means resources on the machine will be made available in either SHARE mode or in USER mode.

No special action is needed other than to create user accounts. Stand-alone servers do not provide network logon services. This means that machines that use this server do not perform a domain logon to it. Whatever logon facility the workstations are subject to is independent of this machine. It is, however, necessary to accommodate any network user

so the logon name they use will be translated (mapped) locally on the Stand-alone Server to a locally known user name. There are several ways this can be done.

Samba tends to blur the distinction a little in respect of what is a Stand-alone Server. This is because the authentication database may be local or on a remote server, even if from the SMB protocol perspective the Samba server is not a member of a domain security context.

Through the use of Pluggable Authentication Modules (PAM) and the name service switcher (NSSWITCH), which maintains the UNIX-user database) the source of authentication may reside on another server. We would be inclined to call this the authentication server. This means that the Samba server may use the local UNIX/Linux system password database (*/etc/passwd* or */etc/shadow*), may use a local *smbpasswd* file, or may use an LDAP backend, or even via PAM and Winbind another CIFS/SMB server for authentication.

7.3 Example Configuration

The examples, Reference Documentation Server, and Central Print Serving, are designed to inspire simplicity. It is too easy to attempt a high level of creativity and to introduce too much complexity in server and network design.

7.3.1 Reference Documentation Server

Configuration of a read-only data server that everyone can access is very simple. Following example is the *smb.conf* file that will do this. Assume that all the reference documents are stored in the directory */export*, and the documents are owned by a user other than nobody. No home directories are shared, and there are no users in the */etc/passwd* UNIX system database. This is a simple system to administer.

Example 7.3.1. *smb.conf* for Reference Documentation Server

```
# Global parameters

[global]
    workgroup = MIDEARTH
    netbios name = GANDALF
    security = SHARE
    passdb backend = guest
    wins server = 192.168.1.1

[data]
    comment = Data
    path = /export
    guest only = Yes
```

In the example above, the machine name is set to GANDALF, the workgroup is set to the name of the local workgroup (MIDEARTH) so the machine will appear together with systems with which users are familiar. The only password backend required is the “*guest*”

backend to allow default unprivileged account names to be used. As there is a WINS server on this network, we obviously make use of it.

7.3.2 Central Print Serving

Configuration of a simple print server is easy if you have all the right tools on your system.

ASSUMPTIONS:

1. The print server must require no administration.
2. The print spooling and processing system on our print server will be CUPS. (Please refer to CUPS Printing Support for more information).
3. The print server will service only network printers. The network administrator will correctly configure the CUPS environment to support the printers.
4. All workstations will use only postscript drivers. The printer driver of choice is the one shipped with the Windows OS for the Apple Color LaserWriter.

In this example our print server will spool all incoming print jobs to `/var/spool/samba` until the job is ready to be submitted by Samba to the CUPS print processor. Since all incoming connections will be as the anonymous (guest) user, two things will be required:

ENABLING ANONYMOUS PRINTING

- The UNIX/Linux system must have a **guest** account. The default for this is usually the account **nobody**. To find the correct name to use for your version of Samba, do the following:

```
$ testparm -s -v | grep "guest account"
```

Make sure that this account exists in your system password database (`/etc/passwd`).

- The directory into which Samba will spool the file must have write access for the guest account. The following commands will ensure that this directory is available for use:

```
root# mkdir /var/spool/samba
root# chown nobody.nobody /var/spool/samba
root# chmod a+rwt /var/spool/samba
```

The contents of the `smb.conf` file is shown in the next example.

Example 7.3.2. smb.conf for Anonymous Printing

```
# Global parameters

[global]
    workgroup = MIDEARTH
    netbios name = GANDALF
    security = SHARE
    passdb backend = guest
    printing = cups
    printcap name = cups

[printers]
    comment = All Printers
    path = /var/spool/samba
    printer admin = root
    guest ok = Yes
    printable = Yes
    use client driver = Yes
    browseable = No
```

NOTE

On CUPS-enabled systems there is a facility to pass raw data directly to the printer without intermediate processing via CUPS print filters. Where use of this mode of operation is desired, it is necessary to configure a raw printing device. It is also necessary to enable the raw mime handler in the `/etc/mime.conv` and `/etc/mime.types` files. Refer to Explicitly Enable “raw” Printing for `application/octet-stream`.

7.4 Common Errors

The greatest mistake so often made is to make a network configuration too complex. It pays to use the simplest solution that will meet the needs of the moment.

MS WINDOWS NETWORK CONFIGURATION GUIDE

8.1 Features and Benefits

Occasionally network administrators will report difficulty getting Microsoft Windows clients to interoperate correctly with Samba servers. It would appear that some folks just can not accept the fact that the right way to configure MS Windows network client is precisely as one would do when using Microsoft Windows NT4 or 200x servers. Yet there is repetitious need to provide detailed Windows client configuration instructions.

The purpose of this chapter is to graphically illustrate MS Windows client configuration for the most common critical aspects of such configuration. An experienced network administrator will not be interested in the details of this chapter.

8.2 Technical Details

This chapter discusses TCP/IP protocol configuration as well as network membership for the platforms that are in common use today. These are:

- Microsoft Windows XP Professional.
- Windows 2000 Professional.
- Windows Millennium edition (Me).

8.2.1 TCP/IP Configuration

The builder of a house must ensure that all construction takes place on a firm foundation. The same is true of TCP/IP-based networking. Fundamental network configuration problems will plague all network users until they are resolved.

Microsoft Windows workstations and servers can be configured either with fixed IP addresses or via DHCP. The examples that follow demonstrate the use of DHCP and make only passing reference to those situations where fixed IP configuration settings can be effected.

It is possible to use shortcuts or abbreviated keystrokes to arrive at a particular configuration screen. The decision was made to base all examples in this chapter on use of the **Start** button.

8.2.1.1 MS Windows XP Professional

There are two paths to the Windows XP TCP/IP configuration panel. Choose the access method that you prefer:

Click **Start** -> **Control Panel** -> **Network Connections**

Alternately, click **Start** ->, and right click **My Network Places** then select **Properties**

The following procedure steps through the Windows XP Professional TCP/IP configuration process:

1. On some installations the interface will be called **Local Area Connection** and on others it will be called **Network Bridge**. On our system it is called **Network Bridge**. Right click on **Network Bridge** -> **Properties**. See Figure 8.1.

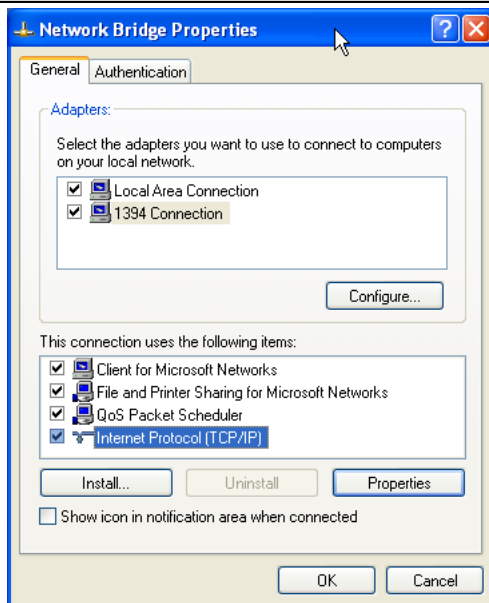

Figure 8.1. Network Bridge Configuration.

2. The Network Bridge Configuration, or Local Area Connection, panel is used to set TCP/IP protocol settings. In **This connection uses the following items:** box, click on **Internet Protocol (TCP/IP)**, then click the on **Properties**. The default setting is DHCP enabled operation. (i.e., “*Obtain an IP address automatically*”). See Figure 8.2.

Many network administrators will want to use DHCP to configure all client TCP/IP protocol stack settings. (For information on how to configure the ISC DHCP server

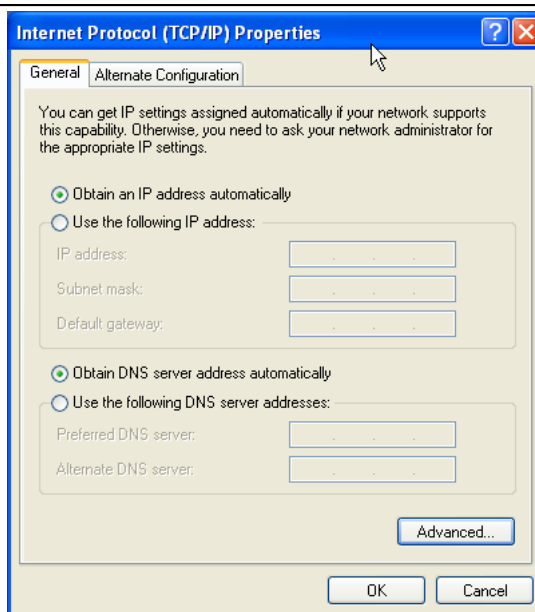

Figure 8.2. Internet Protocol (TCP/IP) Properties.

for Microsoft Windows client support see, Section 40.2.2. If it is necessary to provide a fixed IP address, click on “*Use the following IP address*” and proceed to enter the IP Address, the subnet mask, and the default gateway address in the boxes provided.

3. Click the **Advanced** button to proceed with TCP/IP configuration. This opens a panel in which it is possible to create additional IP Addresses for this interface. The technical name for the additional addresses is *IP Aliases*, and additionally this panel permits the setting of more default gateways (routers). In most cases where DHCP is used, it will not be necessary to create additional settings. See Figure 8.3 to see the appearance of this panel.

Fixed settings may be required for DNS and WINS if these settings are not provided automatically via DHCP.

4. Click the **DNS** tab to add DNS server settings. The example system uses manually configured DNS settings. When finished making changes, click the **OK** to commit the settings. See Figure 8.4.
5. Click the **WINS** tab to add manual WINS server entries. This step demonstrates an example system that uses manually configured WINS settings. When finished making changes click the **OK** to commit the settings. See Figure 8.5.

8.2.1.2 MS Windows 2000

There are two paths to the Windows 2000 Professional TCP/IP configuration panel. Choose the access method that you prefer:

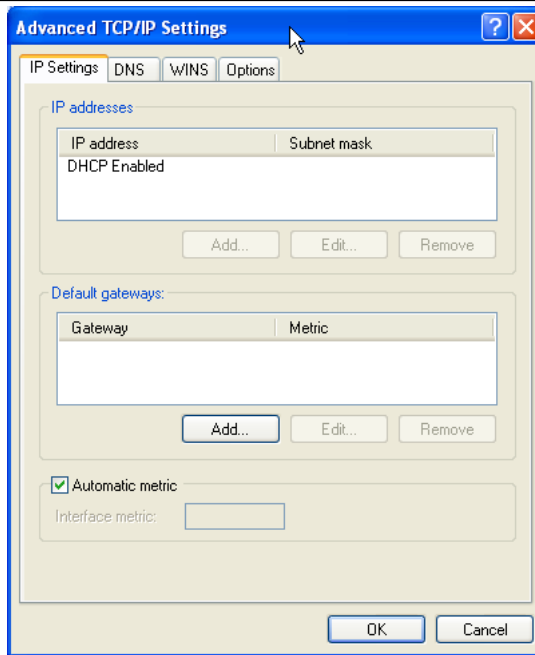

Figure 8.3. Advanced Network Settings

Click **Start** -> **Control Panel** -> **Network and Dial-up Connections**

Alternately, click on **Start**, then right click **My Network Places** and select **Properties**.

The following procedure steps through the Windows XP Professional TCP/IP configuration process:

1. Right click on **Local Area Connection**, now click the **Properties**. See Figure 8.6.
2. The Local Area Connection Properties is used to set TCP/IP protocol settings. Click on **Internet Protocol (TCP/IP)** in the **Components checked are used by this connection:** box, then click the **Properties** button.
3. The default setting is DHCP enabled operation. (i.e., “*Obtain an IP address automatically*”). See Figure 8.7.

Many network administrators will want to use DHCP to configure all client TCP/IP protocol stack settings. (For information on how to configure the ISC DHCP server for Microsoft Windows client support, see Section 40.2.2. If it is necessary to provide a fixed IP address, click on “*Use the following IP address*” and proceed to enter the IP Address, the subnet mask, and the default gateway address in the boxes provided. For this example we are assuming that all network clients will be configured using DHCP.

4. Click the **Advanced** button to proceed with TCP/IP configuration. Refer to Figure 8.8.

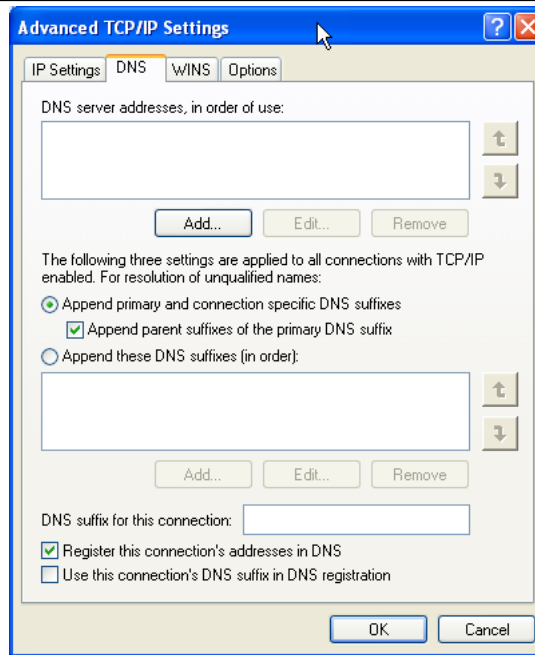

Figure 8.4. DNS Configuration.

Fixed settings may be required for DNS and WINS if these settings are not provided automatically via DHCP.

5. Click the **DNS** tab to add DNS server settings. The example system uses manually configured DNS settings. When finished making changes, click on **OK** to commit the settings. See Figure 8.9.
6. Click the **WINS** tab to add manual WINS server entries. This step demonstrates an example system that uses manually configured WINS settings. When finished making changes, click on **OK** to commit the settings. See Figure 8.10.

8.2.1.3 MS Windows Me

There are two paths to the Windows Millennium edition (Me) TCP/IP configuration panel. Choose the access method that you prefer:

Click **Start -> Control Panel -> Network Connections**

Alternately, click on **Start ->**, and right click on **My Network Places** then select **Properties**.

The following procedure steps through the Windows Me TCP/IP configuration process:

1. In the box labeled **The following network components are installed:**, click on **Internet Protocol TCP/IP**, now click on the **Properties** button. See Figure 8.11.
2. Many network administrators will want to use DHCP to configure all client TCP/IP protocol stack settings. (For information on how to configure the ISC DHCP server

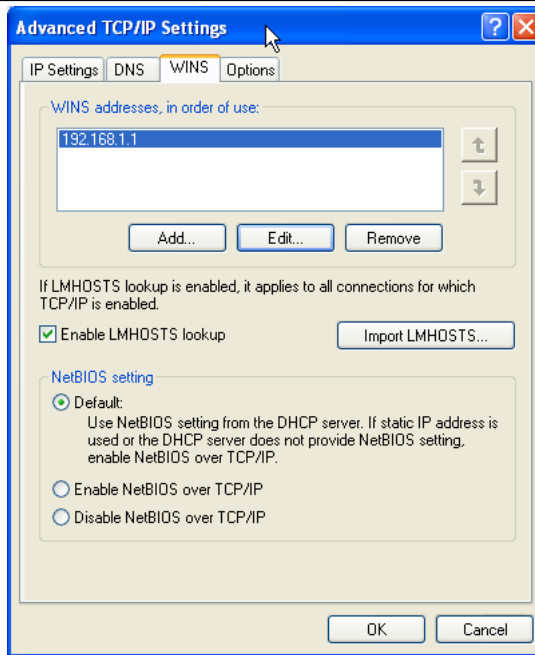

Figure 8.5. WINS Configuration

for Microsoft Windows client support see, Section 40.2.2. The default setting on Microsoft Windows Me workstations is for DHCP enabled operation, i.e., **Obtain IP address automatically** is enabled. See Figure 8.12.

If it is necessary to provide a fixed IP address, click on **Specify an IP address** and proceed to enter the IP Address and the subnet mask in the boxes provided. For this example we are assuming that all network clients will be configured using DHCP.

3. Fixed settings may be required for DNS and WINS if these settings are not provided automatically via DHCP.
4. If necessary, click the **DNS Configuration** tab to add DNS server settings. Click the **WINS Configuration** tab to add WINS server settings. The **Gateway** tab allows additional gateways (router addresses) to be added to the network interface settings. In most cases where DHCP is used, it will not be necessary to create these manual settings.
5. The following example uses manually configured WINS settings. See Figure 8.13. When finished making changes, click on **OK** to commit the settings.

This is an example of a system that uses manually configured WINS settings. One situation where this might apply is on a network that has a single DHCP server that provides settings for multiple Windows workgroups or domains. See Figure 8.14.

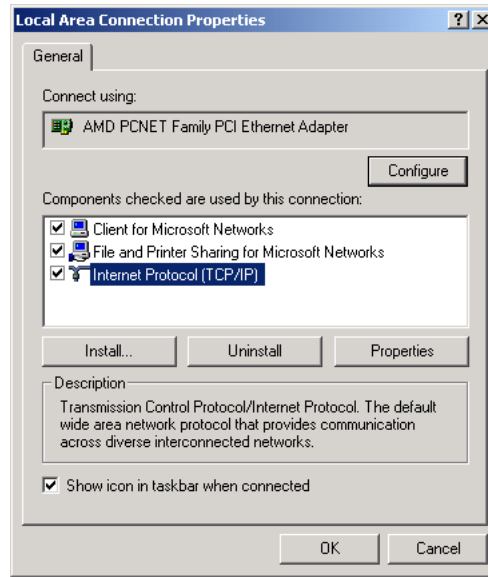

Figure 8.6. Local Area Connection Properties.

8.2.2 Joining a Domain: Windows 2000/XP Professional

Microsoft Windows NT/200x/XP Professional platforms can participate in Domain Security. This section steps through the process for making a Windows 200x/XP Professional machine a member of a Domain Security environment. It should be noted that this process is identical when joining a domain that is controlled by Windows NT4/200x as well as a Samba PDC.

1. Click **Start**.
2. Right click **My Computer**, then select **Properties**.
3. The opening panel is the same one that can be reached by clicking **System** on the Control Panel. See Figure 8.15.
4. Click the **Computer Name** tab. This panel shows the **Computer Description**, the **Full computer name**, and the **Workgroup** or **Domain name**. Clicking the **Network ID** button will launch the configuration wizard. Do not use this with Samba-3. If you wish to change the computer name, join or leave the domain, click the **Change** button. See Figure 8.16.
5. Click on **Change**. This panel shows that our example machine (TEMPTATION) is in a workgroup called WORKGROUP. We will join the domain called MIDEARTH. See Figure 8.17.
6. Enter the name **MIDEARTH** in the field below the Domain radio button. This panel shows that our example machine (TEMPTATION) is set to join the domain called MIDEARTH. See Figure 8.18.
7. Now click the **OK** button. A dialog box should appear to allow you to provide the

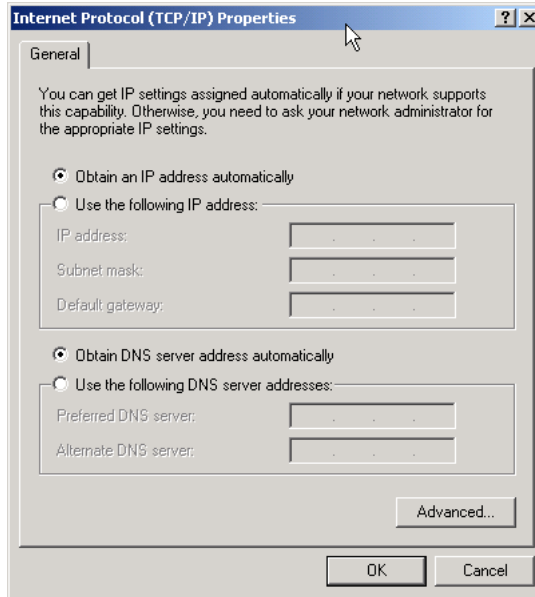

Figure 8.7. Internet Protocol (TCP/IP) Properties.

credentials (username and password) of a Domain administrative account that has the rights to add machines to the Domain. Enter the name “*root*” and the root password from your Samba-3 server. See Figure 8.19.

8. Click on **OK**. The “*Welcome to the MIDEARTH domain.*” dialog box should appear. At this point the machine must be rebooted. Joining the domain is now complete.

8.2.3 Domain Logon Configuration: Windows 9x/Me

We follow the convention used by most in saying that Windows 9x/Me machines can participate in Domain logons. The truth is that these platforms can use only the LanManager network logon protocols.

NOTE



Windows XP Home edition cannot participate in Domain or LanManager network logons.

1. Right click on the **Network Neighborhood** icon.
2. The Network Configuration Panel allows all common network settings to be changed. See Figure 8.20.

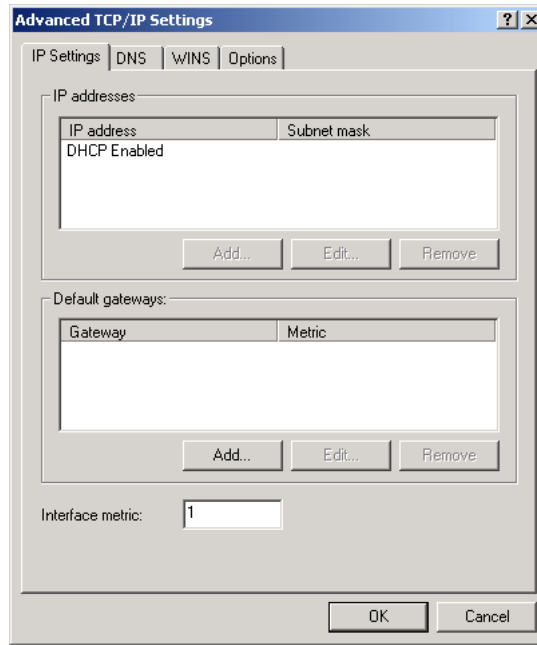

Figure 8.8. Advanced Network Settings.

Make sure that the **Client for Microsoft Networks** driver is installed as shown. Click on the **Client for Microsoft Networks** entry in **The following network components are installed:** box. Then click the **Properties** button.

3. The Client for Microsoft Networks Properties panel is the correct location to configure network logon settings. See Figure 8.21.

Enter the Windows NT domain name, check the **Log on to Windows NT domain** box, click **OK**.

4. Click on the **Identification** button. This is the location at which the workgroup (domain) name and the machine name (computer name) need to be set. See Figure 8.22.
5. Now click the **Access Control** button. If you want to be able to assign share access permissions using domain user and group accounts, it is necessary to enable **User-level access control** as shown in this panel. See Figure 8.23.

8.3 Common Errors

The most common errors that can afflict Windows networking systems include:

- Incorrect IP address.
- Incorrect or inconsistent netmasks.

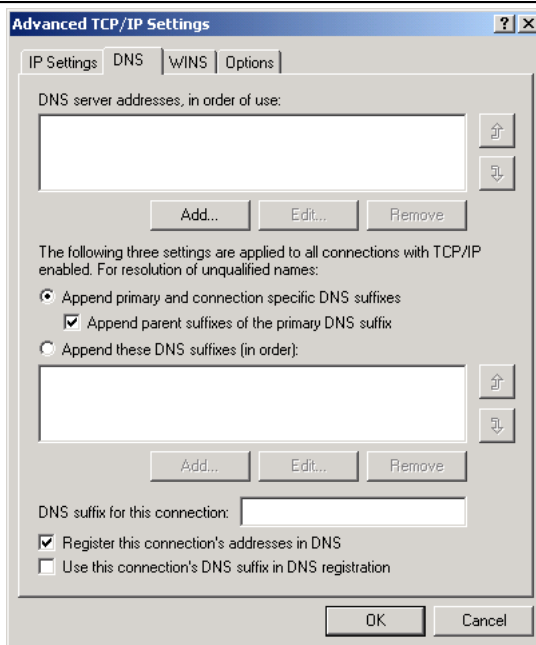

Figure 8.9. DNS Configuration.

- Incorrect router address.
- Incorrect DNS server address.
- Incorrect WINS server address.
- Use of a Network Scope setting — watch out for this one!

The most common reasons for which a Windows NT/200x/XP Professional client cannot join the Samba controlled domain are:

- `smb.conf` does not have correct add machine script settings.
- “*root*” account is not in password backend database.
- Attempt to use a user account instead of the “*root*” account to join a machine to the domain.
- Open connections from the workstation to the server.
- Firewall or filter configurations in place on either the client or on the Samba server.

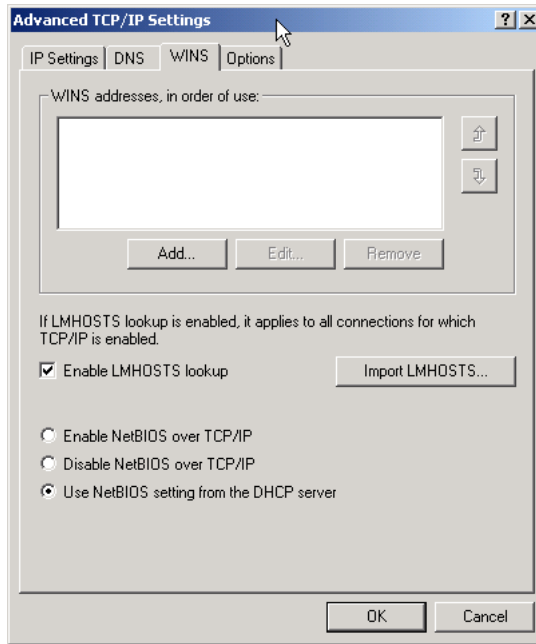

Figure 8.10. WINS Configuration.

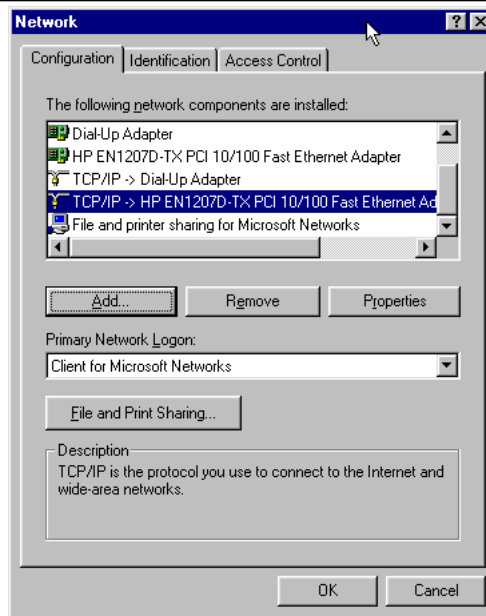

Figure 8.11. The Windows Me Network Configuration Panel.

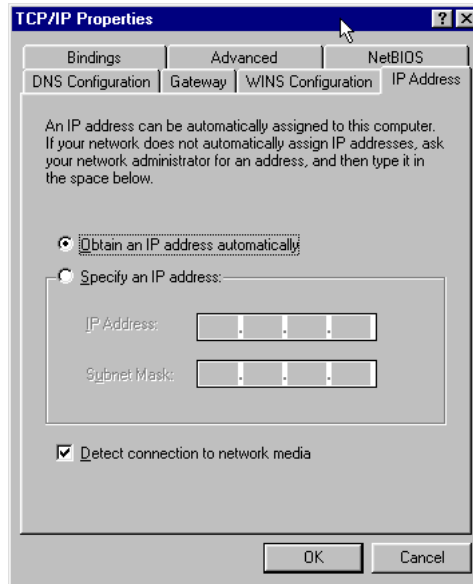

Figure 8.12. IP Address.

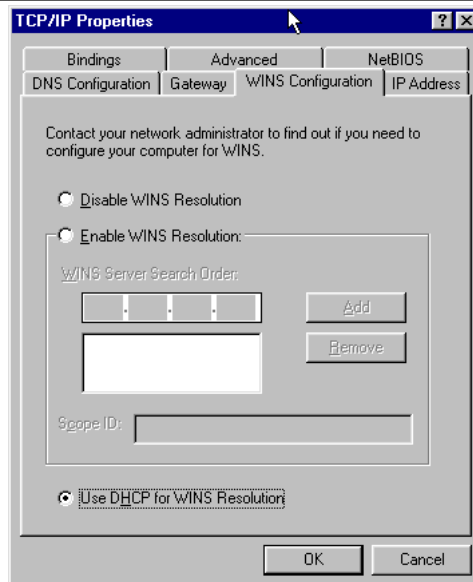

Figure 8.13. DNS Configuration.

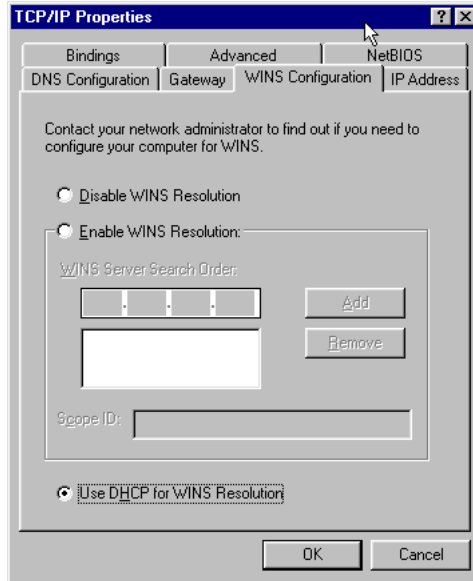

Figure 8.14. WINS Configuration.

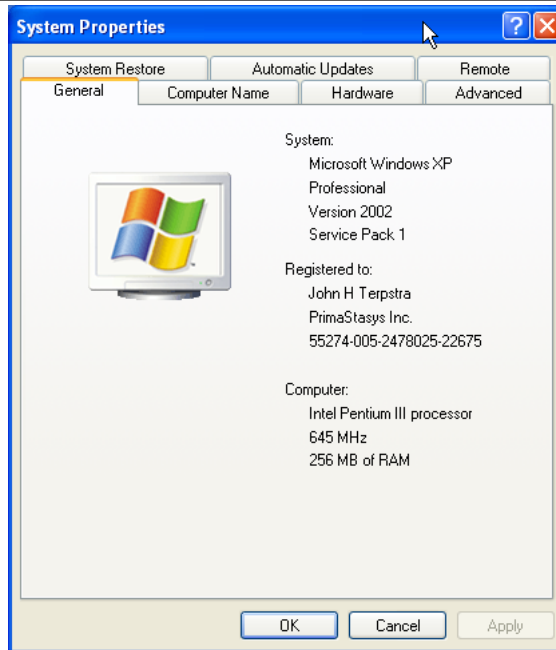

Figure 8.15. The General Panel.

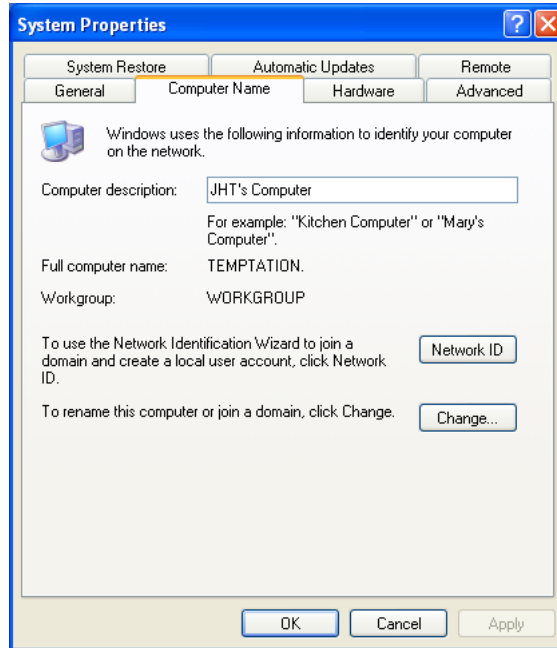

Figure 8.16. The Computer Name Panel.

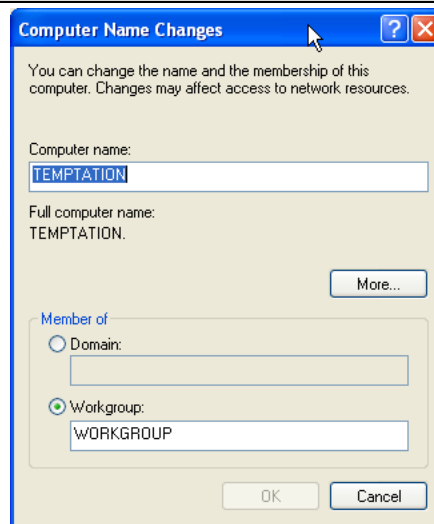

Figure 8.17. The Computer Name Changes Panel.

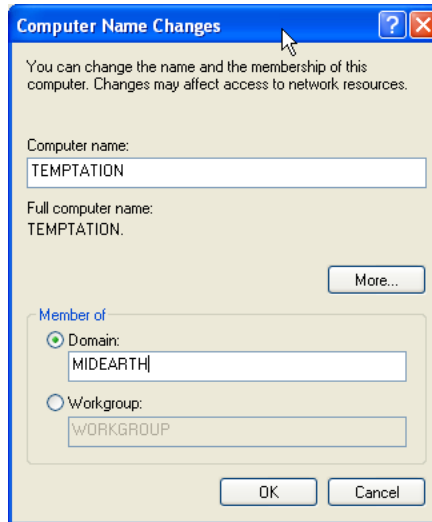

Figure 8.18. The Computer Name Changes Panel Domain MIDEARTH.



Figure 8.19. Computer Name Changes User name and Password Panel.

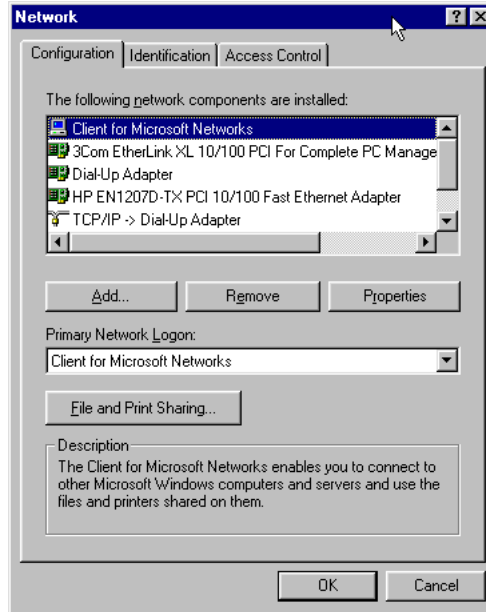

Figure 8.20. The Network Panel.

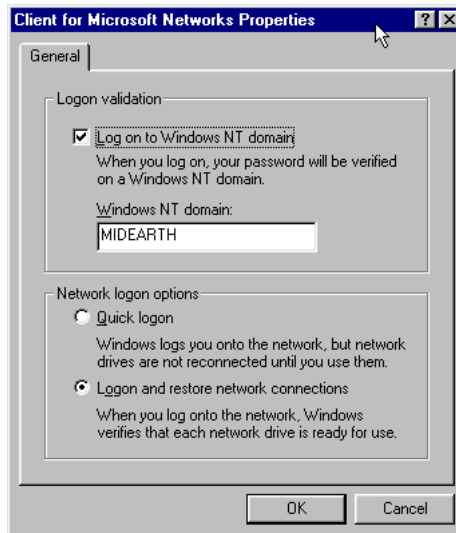

Figure 8.21. Client for Microsoft Networks Properties Panel.

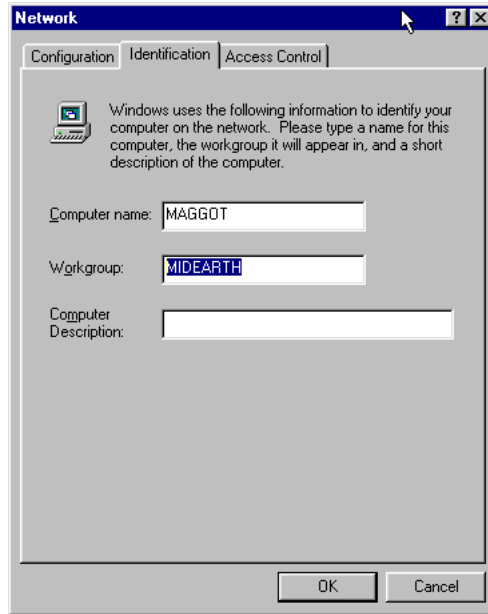

Figure 8.22. Identification Panel.

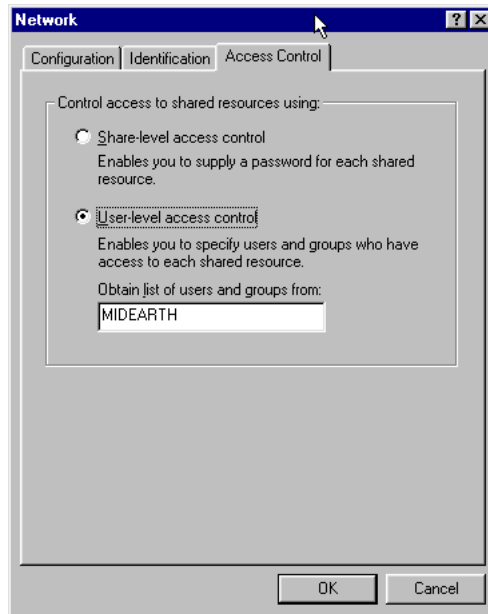

Figure 8.23. Identification Panel.

Part III

Advanced Configuration

VALUABLE NUTS AND BOLTS INFORMATION

Samba has several features that you might want or might not want to use. The chapters in this part each cover specific Samba features.

NETWORK BROWSING

This document contains detailed information as well as a fast track guide to implementing browsing across subnets and/or across workgroups (or domains). WINS is the best tool for resolution of NetBIOS names to IP addresses. WINS is not involved in browse list handling except by way of name to address resolution.

NOTE



MS Windows 2000 and later versions can be configured to operate with no NetBIOS over TCP/IP. Samba-3 and later versions also support this mode of operation. When the use of NetBIOS over TCP/IP has been disabled, the primary means for resolution of MS Windows machine names is via DNS and Active Directory. The following information assumes that your site is running NetBIOS over TCP/IP.

9.1 Features and Benefits

Someone once referred to the past in these words “It was the best of times, it was the worst of times.” The more we look back, the more we long for what was and hope it never returns.

For many MS Windows network administrators, that statement sums up their feelings about NetBIOS networking precisely. For those who mastered NetBIOS networking, its fickle nature was just par for the course. For those who never quite managed to tame its lusty features, NetBIOS is like Paterson’s Curse.

For those not familiar with botanical problems in Australia, Paterson’s Curse, *Echium plantagineum*, was introduced to Australia from Europe during the mid-nineteenth century. Since then it has spread rapidly. The high seed production, with densities of thousands of seeds per square meter, a seed longevity of more than seven years, and an ability to germinate at any time of year, given the right conditions, are some of the features which make it such a persistent weed.

In this chapter we explore vital aspects of Server Message Block (SMB) networking with a particular focus on SMB as implemented through running NetBIOS (Network Basic Input/Output System) over TCP/IP. Since Samba does not implement SMB or NetBIOS over any other protocols, we need to know how to configure our network environment and simply remember to use nothing but TCP/IP on all our MS Windows network clients.

Samba provides the ability to implement a WINS (Windows Inter-networking Name Server) and implements extensions to Microsoft's implementation of WINS. These extensions help Samba to effect stable WINS operations beyond the normal scope of MS WINS.

WINS is exclusively a service that applies only to those systems that run NetBIOS over TCP/IP. MS Windows 200x/XP have the capacity to operate with support for NetBIOS disabled, in which case WINS is of no relevance. Samba supports this also.

For those networks on which NetBIOS has been disabled (i.e., WINS is not required) the use of DNS is necessary for host name resolution.

9.2 What Is Browsing?

To most people browsing means they can see the MS Windows and Samba servers in the Network Neighborhood, and when the computer icon for a particular server is clicked, it opens up and shows the shares and printers available on the target server.

What seems so simple is in fact a complex interaction of different technologies. The technologies (or methods) employed in making all of this work include:

- MS Windows machines register their presence to the network.
- Machines announce themselves to other machines on the network.
- One or more machine on the network collates the local announcements.
- The client machine finds the machine that has the collated list of machines.
- The client machine is able to resolve the machine names to IP addresses.
- The client machine is able to connect to a target machine.

The Samba application that controls browse list management and name resolution is called `nmbd`. The configuration parameters involved in `nmbd`'s operation are:

Browsing options: `os level(*)`, `lm announce`, `lm interval`, `preferred master(*)`, `local master(*)`, `domain master(*)`, `browse list`, `enhanced browsing`.

Name Resolution Method: `name resolve order(*)`.

WINS options: `dns proxy`, `wins proxy`, `wins server(*)`, `wins support(*)`, `wins hook`.

For Samba, the WINS Server and WINS Support are mutually exclusive options. Those marked with an (*) are the only options that commonly may need to be modified. Even if none of these parameters is set, `nmbd` will still do its job.

9.3 Discussion

All MS Windows networking uses SMB-based messaging. SMB messaging may be implemented with or without NetBIOS. MS Windows 200x supports NetBIOS over TCP/IP for backwards compatibility. Microsoft appears intent on phasing out NetBIOS support.

9.3.1 NetBIOS over TCP/IP

Samba implements NetBIOS, as does MS Windows NT/200x/XP, by encapsulating it over TCP/IP. MS Windows products can do likewise. NetBIOS-based networking uses broadcast messaging to effect browse list management. When running NetBIOS over TCP/IP, this uses UDP-based messaging. UDP messages can be broadcast or unicast.

Normally, only uni-cast UDP messaging can be forwarded by routers. The remote announce parameter to `smb.conf` helps to project browse announcements to remote network segments via uni-cast UDP. Similarly, the remote browse sync parameter of `smb.conf` implements browse list collation using uni-cast UDP.

The methods used by MS Windows to perform name lookup requests (name resolution) is determined by a configuration parameter called the `netbios node-type`. There are four (4) basic NetBIOS node types:

- *b-node (type 0x01)*: The Windows client will use only NetBIOS broadcast requests using UDP broadcast.
- *p-node (type 0x02)*: The Windows client will use point-to-point (NetBIOS unicast) requests using UDP unicast directed to a WINS server.
- *m-node (type 0x04)*: The Windows client will first use NetBIOS broadcast requests using UDP broadcast, then it will use (NetBIOS unicast) requests using UDP unicast directed to a WINS server.
- *h-node (type 0x08)*: The Windows client will use (NetBIOS unicast) requests using UDP unicast directed to a WINS server, then it will use NetBIOS broadcast requests using UDP broadcast.

The default Windows network client (or server) network configuration enables NetBIOS over TCP/IP and b-node configuration. The use of WINS makes most sense with h-node (Hybrid mode) operation so that in the event of a WINS breakdown or non-availability the client can use broadcast based name resolution.

In those networks where Samba is the only SMB server technology, wherever possible `nmbd` should be configured on one machine as the WINS server. This makes it easy to manage the browsing environment. If each network segment is configured with its own Samba WINS server, then the only way to get cross-segment browsing to work is by using the remote announce and the remote browse sync parameters to your `smb.conf` file.

If only one WINS server is used for an entire multi-segment network, then the use of the remote announce and the remote browse sync parameters should not be necessary.

As of Samba-3 WINS replication is being worked on. The bulk of the code has been committed, but it still needs maturation. This is not a supported feature of the Samba-3.0.0

release. Hopefully, this will become a supported feature of one of the Samba-3 release series.

Right now Samba WINS does not support MS-WINS replication. This means that when setting up Samba as a WINS server, there must only be one `nmbd` configured as a WINS server on the network. Some sites have used multiple Samba WINS servers for redundancy (one server per subnet) and then used `remote browse sync` and `remote announce` to effect browse list collation across all segments. Note that this means clients will only resolve local names, and must be configured to use DNS to resolve names on other subnets in order to resolve the IP addresses of the servers they can see on other subnets. This setup is not recommended, but is mentioned as a practical consideration (i.e., an “*if all else fails*” scenario).

Lastly, take note that browse lists are a collection of unreliable broadcast messages that are repeated at intervals of not more than 15 minutes. This means that it will take time to establish a browse list and it can take up to 45 minutes to stabilize, particularly across network segments.

When an MS Windows 200x/XP system attempts to resolve a host name to an IP address it follows a defined path:

1. Checks the `hosts` file. It is located in `%SystemRoot%\System32\Drivers\etc`.
2. Does a DNS lookup.
3. Checks the NetBIOS name cache.
4. Queries the WINS server.
5. Does a broadcast name lookup over UDP.
6. Looks up entries in LMHOSTS, located in `%SystemRoot%\System32\Drivers\etc`.

9.3.2 TCP/IP without NetBIOS

All TCP/IP-enabled systems use various forms of host name resolution. The primary methods for TCP/IP hostname resolution involve either a static file (`/etc/hosts`) or the Domain Name System (DNS). DNS is the technology that makes the Internet usable. DNS-based host name resolution is supported by nearly all TCP/IP-enabled systems. Only a few embedded TCP/IP systems do not support DNS.

Windows 200x/XP can register its host name with a Dynamic DNS server. You can force register with a Dynamic DNS server in Windows 200x/XP using: `ipconfig /registerdns`.

With Active Directory (ADS), a correctly functioning DNS server is absolutely essential. In the absence of a working DNS server that has been correctly configured, MS Windows clients and servers will be unable to locate each other, so consequently network services will be severely impaired.

The use of Dynamic DNS is highly recommended with Active Directory, in which case the use of BIND9 is preferred for its ability to adequately support the SRV (service) records that are needed for Active Directory.

Use of raw SMB over TCP/IP (No NetBIOS layer) can be done only with Active Directory domains. Samba is not an Active Directory Domain Controller: ergo, it is not possible

run Samba as a domain controller and at the same time NOT use NetBIOS. Where Samba is used as an Active Directory Domain Member Server (DMS) it is possible to configure Samba to not use NetBIOS over TCP/IP. A Samba DMS can integrate fully into an Active Directory domain.

9.3.3 DNS and Active Directory

Occasionally we hear from UNIX network administrators who want to use a UNIX-based Dynamic DNS server in place of the Microsoft DNS server. While this might be desirable to some, the MS Windows 200x DNS server is auto-configured to work with Active Directory. It is possible to use BIND version 8 or 9, but it will almost certainly be necessary to create service records (SRV records) so MS Active Directory clients can resolve host names to locate essential network services. The following are some of the default service records that Active Directory requires:

_ldap._tcp.pdc._msdcs.Domain This provides the address of the Windows NT PDC for the Domain.

_ldap._tcp.pdc._msdcs.DomainTree Resolves the addresses of Global Catalog servers in the domain.

_ldap._tcp.site.sites.writable._msdcs.Domain Provides list of Domain Controllers based on sites.

_ldap._tcp.writable._msdcs.Domain Enumerates list of Domain Controllers that have the writable copies of the Active Directory data-store.

_ldap._tcp.GUID.domains._msdcs.DomainTree Entry used by MS Windows clients to locate machines using the Global Unique Identifier.

_ldap._tcp.Site.gc._msdcs.DomainTree Used by MS Windows clients to locate site configuration dependent Global Catalog server.

Specific entries used by Microsoft clients to locate essential services for an example domain called `quenia.org` includes:

- `_kerberos._udp.quenia.org` — Used to contact the KDC server via UDP. This entry must list port 88 for each KDC.
- `_kpasswd._udp.quenia.org` — Used to locate the `kpasswd` server when a user password change must be processed. This record must list port 464 on the master KDC.
- `_kerberos._tcp.quenia.org` — Used to locate the KDC server via TCP. This entry must list port 88 for each KDC.
- `_ldap._tcp.quenia.org` — Used to locate the LDAP service on the PDC. This record must list port 389 for the PDC.

- `_kpasswd._tcp.kenya.org` — Used to locate the `kpasswd` server to permit user password changes to be processed. This must list port 464.
- `_gc._tcp.kenya.org` — Used to locate the Global Catalog server for the top of the domain. This must list port 3268.

The following records are also used by the Windows Domain Member client to locate vital services on the Windows ADS domain controllers.

- `_ldap._tcp.pdc._msdcs.kenya.org`
- `_ldap.gc._msdcs.kenya.org`
- `_ldap.default-first-site-name._sites.gc._msdcs.kenya.org`
- `_ldap.{SecID}.domains._msdcs.kenya.org`
- `_ldap._tcp.dc._msdcs.kenya.org`
- `_kerberos._tcp.dc._msdcs.kenya.org`
- `_ldap.default-first-site-name._sites.dc._msdcs.kenya.org`
- `_kerberos.default-first-site-name._sites.dc._msdcs.kenya.org`
- `SecID._msdcs.kenya.org`

Presence of the correct DNS entries can be validated by executing:

```
root# dig @frodo -t any _ldap._tcp.dc._msdcs.kenya.org

; <lt;>> DiG 9.2.2 <lt;>> @frodo -t any _ldap._tcp.dc._msdcs.kenya.org
;; global options: printcmd
;; Got answer:
;; ->>HEADER<<- opcode: QUERY, status: NOERROR, id: 3072
;; flags: qr aa rd ra; QUERY: 1, ANSWER: 2, AUTHORITY: 0, ADDITIONAL: 2

;; QUESTION SECTION:
;_ldap._tcp.dc._msdcs.kenya.org. IN      ANY

;; ANSWER SECTION:
_ldap._tcp.dc._msdcs.kenya.org. 600 IN SRV 0 100 389 frodo.kenya.org.
_ldap._tcp.dc._msdcs.kenya.org. 600 IN SRV 0 100 389 noldor.kenya.org.

;; ADDITIONAL SECTION:
frodo.kenya.org. 3600 IN      A          10.1.1.16
noldor.kenya.org. 1200 IN      A          10.1.1.17

;; Query time: 0 msec
```



```
;; SERVER: frodo#53(10.1.1.16)
;; WHEN: Wed Oct 7 14:39:31 2004
;; MSG SIZE rcvd: 171
```

9.4 How Browsing Functions

MS Windows machines register their NetBIOS names (i.e., the machine name for each service type in operation) on start-up. The exact method by which this name registration takes place is determined by whether or not the MS Windows client/server has been given a WINS server address, whether or not LMHOSTS lookup is enabled, or if DNS for NetBIOS name resolution is enabled, etc.

In the case where there is no WINS server, all name registrations as well as name lookups are done by UDP broadcast. This isolates name resolution to the local subnet, unless LMHOSTS is used to list all names and IP addresses. In such situations, Samba provides a means by which the Samba server name may be forcibly injected into the browse list of a remote MS Windows network (using the remote announce parameter).

Where a WINS server is used, the MS Windows client will use UDP uni-cast to register with the WINS server. Such packets can be routed and thus WINS allows name resolution to function across routed networks.

During the startup process an election will take place to create a Local Master Browser if one does not already exist. On each NetBIOS network one machine will be elected to function as the Domain Master Browser. This domain browsing has nothing to do with MS security Domain Control. Instead, the Domain Master Browser serves the role of contacting each local master browser (found by asking WINS or from LMHOSTS) and exchanging browse list contents. This way every master browser will eventually obtain a complete list of all machines that are on the network. Every 11 to 15 minutes an election is held to determine which machine will be the master browser. By the nature of the election criteria used, the machine with the highest uptime, or the most senior protocol version or other criteria, will win the election as Domain Master Browser.

Clients wishing to browse the network make use of this list, but also depend on the availability of correct name resolution to the respective IP address/addresses.

Any configuration that breaks name resolution and/or browsing intrinsics will annoy users because they will have to put up with protracted inability to use the network services.

Samba supports a feature that allows forced synchronization of browse lists across routed networks using the remote browse sync parameter in the `smb.conf` file. This causes Samba to contact the local master browser on a remote network and to request browse list synchronization. This effectively bridges two networks that are separated by routers. The two remote networks may use either broadcast-based name resolution or WINS-based name resolution, but it should be noted that the remote browse sync parameter provides browse list synchronization — and that is distinct from name to address resolution. In other words, for cross-subnet browsing to function correctly it is essential that a name-to-address resolution mechanism be provided. This mechanism could be via DNS, `/etc/hosts`, and so on.

9.4.1 Configuring WORKGROUP Browsing

To configure cross-subnet browsing on a network containing machines in a WORKGROUP, not an NT Domain, you need to set up one Samba server to be the Domain Master Browser (note that this is not the same as a Primary Domain Controller, although in an NT Domain the same machine plays both roles). The role of a Domain Master Browser is to collate the browse lists from Local Master Browsers on all the subnets that have a machine participating in the workgroup. Without one machine configured as a Domain Master Browser, each subnet would be an isolated workgroup unable to see any machines on another subnet. It is the presence of a Domain Master Browser that makes cross-subnet browsing possible for a workgroup.

In a WORKGROUP environment the Domain Master Browser must be a Samba server, and there must only be one Domain Master Browser per workgroup name. To set up a Samba server as a Domain Master Browser, set the following option in the *[global]* section of the `smb.conf` file:

```
domain master = yes
```

The Domain Master Browser should preferably be the local master browser for its own subnet. In order to achieve this, set the following options in the *[global]* section of the `smb.conf` file as shown in the following example:

Example 9.4.1. Domain Master Browser `smb.conf`

```
[global]  
domain master = yes  
local master = yes  
preferred master = yes  
os level = 65
```

The Domain Master Browser may be the same machine as the WINS server, if necessary.

Next, you should ensure that each of the subnets contains a machine that can act as a Local Master Browser for the workgroup. Any MS Windows NT/200x/XP machine should be able to do this, as will Windows 9x/Me machines (although these tend to get rebooted more often, so it is not such a good idea to use these). To make a Samba server a Local Master Browser set the following options in the *[global]* section of the `smb.conf` file as shown in following example:

Example 9.4.2. Local master browser `smb.conf`

```
[global]  
domain master = no  
local master = yes  
preferred master = yes  
os level = 65
```

Do not do this for more than one Samba server on each subnet, or they will war with each other over which is to be the Local Master Browser.

The local master parameter allows Samba to act as a Local Master Browser. The preferred master causes **nmbd** to force a browser election on startup and the `os level` parameter sets Samba high enough so it should win any browser elections.

If you have an NT machine on the subnet that you wish to be the Local Master Browser, you can disable Samba from becoming a Local Master Browser by setting the following options in the `[global]` section of the `smb.conf` file as shown in following example:

Example 9.4.3. `smb.conf` for not being a Master Browser

```
[global]
    domain master = no
    local master = no
    preferred master = no
    os level = 0
```

9.4.2 DOMAIN Browsing Configuration

If you are adding Samba servers to a Windows NT Domain, then you must not set up a Samba server as a Domain Master Browser. By default, a Windows NT Primary Domain Controller for a domain is also the Domain Master Browser for that domain. Network browsing may break if a Samba server registers the domain master browser NetBIOS name (`DOMAIN<1B>`) with WINS instead of the PDC.

For subnets other than the one containing the Windows NT PDC, you may set up Samba servers as Local Master Browsers as described. To make a Samba server a Local Master Browser, set the following options in the `[global]` section of the `smb.conf` file as shown in following example:

Example 9.4.4. Local Master Browser `smb.conf`

```
[global]
    domain master = no
    local master = yes
    preferred master = yes
    os level = 65
```

If you wish to have a Samba server fight the election with machines on the same subnet you may set the `os level` parameter to lower levels. By doing this you can tune the order of machines that will become Local Master Browsers if they are running. For more details on this refer to Forcing Samba to Be the Master section.

If you have Windows NT machines that are members of the domain on all subnets and you are sure they will always be running, you can disable Samba from taking part in browser

elections and ever becoming a Local Master Browser by setting the following options in the `[global]` section of the `smb.conf` file as shown in next example:

Example 9.4.5. `smb.conf` for not being a master browser

```
[global]
    domain master = no
    local master = no
    preferred master = no
    os level = 0
```

9.4.3 Forcing Samba to Be the Master

Who becomes the master browser is determined by an election process using broadcasts. Each election packet contains a number of parameters that determine what precedence (bias) a host should have in the election. By default Samba uses a low precedence and thus loses elections to just about every Windows network server or client.

If you want Samba to win elections, set the `os level` global option in `smb.conf` to a higher number. It defaults to 20. Using 34 would make it win all elections every other system (except other samba systems).

An `os level` of two would make it beat Windows for Workgroups and Windows 9x/Me, but not MS Windows NT/200x Server. An MS Windows NT/200x Server Domain Controller uses level 32. The maximum `os level` is 255.

If you want Samba to force an election on startup, set the `preferred master` global option in `smb.conf` to `yes`. Samba will then have a slight advantage over other potential master browsers that are not Preferred Master Browsers. Use this parameter with care, as if you have two hosts (whether they are Windows 9x/Me or NT/200x/XP or Samba) on the same local subnet both set with `preferred master` to `yes`, then periodically and continually they will force an election in order to become the Local Master Browser.

If you want Samba to be a *Domain Master Browser*, then it is recommended that you also set `preferred master` to `yes`, because Samba will not become a Domain Master Browser for the whole of your LAN or WAN if it is not also a Local Master Browser on its own broadcast isolated subnet.

It is possible to configure two Samba servers to attempt to become the Domain Master Browser for a domain. The first server that comes up will be the Domain Master Browser. All other Samba servers will attempt to become the Domain Master Browser every five minutes. They will find that another Samba server is already the domain master browser and will fail. This provides automatic redundancy, should the current Domain Master Browser fail.

9.4.4 Making Samba the Domain Master

The domain master is responsible for collating the browse lists of multiple subnets so browsing can occur between subnets. You can make Samba act as the Domain Master by setting `domain master = yes` in `smb.conf`. By default it will not be a Domain Master.

Do not set Samba to be the Domain Master for a workgroup that has the same name as an NT/200x Domain. If Samba is configured to be the Domain Master for a workgroup that is present on the same network as a Windows NT/200x domain that has the same name, network browsing problems will certainly be experienced.

When Samba is the Domain Master and the Master Browser, it will listen for master announcements (made roughly every twelve minutes) from Local Master Browsers on other subnets and then contact them to synchronize browse lists.

If you want Samba to be the domain master, you should also set the `os level` high enough to make sure it wins elections, and set `preferred master` to `yes`, to get Samba to force an election on startup.

All servers (including Samba) and clients should be using a WINS server to resolve NetBIOS names. If your clients are only using broadcasting to resolve NetBIOS names, then two things will occur:

1. Local Master Browsers will be unable to find a Domain Master Browser, as they will be looking only on the local subnet.
2. If a client happens to get hold of a domain-wide browse list and a user attempts to access a host in that list, it will be unable to resolve the NetBIOS name of that host.

If, however, both Samba and your clients are using a WINS server, then:

1. Local master browsers will contact the WINS server and, as long as Samba has registered that it is a Domain Master Browser with the WINS server, the Local Master Browser will receive Samba's IP address as its Domain Master Browser.
2. When a client receives a domain-wide browse list and a user attempts to access a host in that list, it will contact the WINS server to resolve the NetBIOS name of that host. As long as that host has registered its NetBIOS name with the same WINS server, the user will be able to see that host.

9.4.5 Note about Broadcast Addresses

If your network uses a 0 based broadcast address (for example, if it ends in a 0) then you will strike problems. Windows for Workgroups does not seem to support a zeros broadcast and you will probably find that browsing and name lookups will not work.

9.4.6 Multiple Interfaces

Samba supports machines with multiple network interfaces. If you have multiple interfaces, you will need to use the `interfaces` option in `smb.conf` to configure them.

9.4.7 Use of the Remote Announce Parameter

The remote announce parameter of `smb.conf` can be used to forcibly ensure that all the NetBIOS names on a network get announced to a remote network. The syntax of the remote announce parameter is:

```
remote announce = a.b.c.d [e.f.g.h] ... or  
remote announce = a.b.c.d/WORKGROUP [e.f.g.h/WORKGROUP] ... where:
```

a.b.c.d and *e.f.g.h* is either the LMB (Local Master Browser) IP address or the broadcast address of the remote network. i.e., the LMB is at 192.168.1.10, or the address could be given as 192.168.1.255 where the netmask is assumed to be 24 bits (255.255.255.0). When the remote announcement is made to the broadcast address of the remote network, every host will receive our announcements. This is noisy and therefore undesirable but may be necessary if we do not know the IP address of the remote LMB.

WORKGROUP is optional and can be either our own workgroup or that of the remote network. If you use the workgroup name of the remote network, our NetBIOS machine names will end up looking like they belong to that workgroup. This may cause name resolution problems and should be avoided.

9.4.8 Use of the Remote Browse Sync Parameter

The remote browse sync parameter of `smb.conf` is used to announce to another LMB that it must synchronize its NetBIOS name list with our Samba LMB. This works only if the Samba server that has this option is simultaneously the LMB on its network segment.

The syntax of the remote browse sync parameter is:

```
remote browse sync = a.b.c.d
```

where *a.b.c.d* is either the IP address of the remote LMB or else is the network broadcast address of the remote segment.

9.5 WINS — The Windows Inter-networking Name Server

Use of WINS (either Samba WINS or MS Windows NT Server WINS) is highly recommended. Every NetBIOS machine registers its name together with a `name_type` value for each of several types of service it has available. It registers its name directly as a unique (the type 0x03) name. It also registers its name if it is running the LanManager compatible server service (used to make shares and printers available to other users) by registering the server (the type 0x20) name.

All NetBIOS names are up to 15 characters in length. The `name_type` variable is added to the end of the name, thus creating a 16 character name. Any name that is shorter than 15 characters is padded with spaces to the 15th character. Thus, all NetBIOS names are 16 characters long (including the `name_type` information).

WINS can store these 16-character names as they get registered. A client that wants to log onto the network can ask the WINS server for a list of all names that have registered the NetLogon service `name_type`. This saves broadcast traffic and greatly expedites logon

processing. Since broadcast name resolution cannot be used across network segments this type of information can only be provided via WINS or via a statically configured `lmhosts` file that must reside on all clients in the absence of WINS.

WINS also serves the purpose of forcing browse list synchronization by all LMBs. LMBs must synchronize their browse list with the DMB (Domain Master Browser) and WINS helps the LMB to identify its DMB. By definition this will work only within a single workgroup. Note that the Domain Master Browser has nothing to do with what is referred to as an MS Windows NT Domain. The later is a reference to a security environment while the DMB refers to the master controller for browse list information only.

WINS will work correctly only if every client TCP/IP protocol stack has been configured to use the WINS servers. Any client that has not been configured to use the WINS server will continue to use only broadcast-based name registration so WINS may never get to know about it. In any case, machines that have not registered with a WINS server will fail name to address lookup attempts by other clients and will therefore cause workstation access errors.

To configure Samba as a WINS server just add `wins support = yes` to the `smb.conf` file `[global]` section.

To configure Samba to register with a WINS server just add `wins server = a.b.c.d` to your `smb.conf` file `[global]` section.

IMPORTANT

Never use both `wins support = yes` together with `wins server = a.b.c.d` particularly not using its own IP address. Specifying both will cause `nmbd` to refuse to start!

9.5.1 WINS Server Configuration

Either a Samba Server or a Windows NT Server machine may be set up as a WINS server. To configure a Samba Server to be a WINS server you must add to the `smb.conf` file on the selected Server the following line to the `[global]` section:

```
wins support = yes
```

Versions of Samba prior to 1.9.17 had this parameter default to `yes`. If you have any older versions of Samba on your network it is strongly suggested you upgrade to a recent version, or at the very least set the parameter to `no` on all these machines.

Machines configured with `wins support = yes` will keep a list of all NetBIOS names registered with them, acting as a DNS for NetBIOS names.

It is strongly recommended to set up only one WINS server. Do not set the `wins support = yes` option on more than one Samba server.

To configure Windows NT/200x Server as a WINS server, install and configure the WINS service. See the Windows NT/200x documentation for details. Windows NT/200x WINS servers can replicate to each other, allowing more than one to be set up in a complex subnet environment. As Microsoft refuses to document the replication protocols, Samba cannot currently participate in these replications. It is possible in the future that a Samba-to-Samba WINS replication protocol may be defined, in which case more than one Samba machine could be set up as a WINS server. Currently only one Samba server should have the `wins support = yes` parameter set.

After the WINS server has been configured, you must ensure that all machines participating on the network are configured with the address of this WINS server. If your WINS server is a Samba machine, fill in the Samba machine IP address in the **Primary WINS Server** field of the **Control Panel->Network->Protocols->TCP->WINS Server** dialogs in Windows 9x/Me or Windows NT/200x. To tell a Samba server the IP address of the WINS server, add the following line to the *[global]* section of all `smb.conf` files:

```
wins server = <name or IP address>
```

where `<name or IP address>` is either the DNS name of the WINS server machine or its IP address.

This line must not be set in the `smb.conf` file of the Samba server acting as the WINS server itself. If you set both the `wins support = yes` option and the `wins server = <name>` option then `nmbd` will fail to start.

There are two possible scenarios for setting up cross-subnet browsing. The first details setting up cross-subnet browsing on a network containing Windows 9x/Me, Samba and Windows NT/200x machines that are not configured as part of a Windows NT Domain. The second details setting up cross-subnet browsing on networks that contain NT Domains.

9.5.2 WINS Replication

Samba-3 permits WINS replication through the use of the `wrepld` utility. This tool is not currently capable of being used as it is still in active development. As soon as this tool becomes moderately functional, we will prepare man pages and enhance this section of the documentation to provide usage and technical details.

9.5.3 Static WINS Entries

Adding static entries to your Samba WINS server is actually fairly easy. All you have to do is add a line to `wins.dat`, typically located in `/usr/local/samba/var/locks` or `/var/run/samba`.

Entries in `wins.dat` take the form of:

```
"NAME#TYPE" TTL ADDRESS+ FLAGS
```

where NAME is the NetBIOS name, TYPE is the NetBIOS type, TTL is the time-to-live as an absolute time in seconds, ADDRESS+ is one or more addresses corresponding to the registration and FLAGS are the NetBIOS flags for the registration.

A typical dynamic entry looks like this:

```
"MADMAN#03" 1055298378 192.168.1.2 66R
```

To make it static, all that has to be done is set the TTL to 0, like this:

```
"MADMAN#03" 0 192.168.1.2 66R
```

Though this method works with early Samba-3 versions, there is a possibility that it may change in future versions if WINS replication is added.

9.6 Helpful Hints

The following hints should be carefully considered as they are stumbling points for many new network administrators.

9.6.1 Windows Networking Protocols

A common cause of browsing problems results from installing more than one protocol on an MS Windows machine.

WARNING

Do not use more than one protocol on MS Windows clients.

Every NetBIOS machine takes part in a process of electing the LMB (and DMB) every 15 minutes. A set of election criteria is used to determine the order of precedence for winning this election process. A machine running Samba or Windows NT will be biased so the most suitable machine will predictably win and thus retain its role.

The election process is “*fought out*” so to speak over every NetBIOS network interface. In the case of a Windows 9x/Me machine that has both TCP/IP and IPX installed and has NetBIOS enabled over both protocols, the election will be decided over both protocols. As often happens, if the Windows 9x/Me machine is the only one with both protocols then the LMB may be won on the NetBIOS interface over the IPX protocol. Samba will then lose the LMB role as Windows 9x/Me will insist it knows who the LMB is. Samba will then

cease to function as an LMB and thus browse list operation on all TCP/IP-only machines will fail.

Windows 95, 98, 98se, and Me are referred to generically as Windows 9x/Me. The Windows NT4, 200x, and XP use common protocols. These are roughly referred to as the Windows NT family, but it should be recognized that 2000 and XP/2003 introduce new protocol extensions that cause them to behave differently from MS Windows NT4. Generally, where a server does not support the newer or extended protocol, these will fall back to the NT4 protocols.

The safest rule of all to follow is: use only one protocol!

9.6.2 Name Resolution Order

Resolution of NetBIOS names to IP addresses can take place using a number of methods. The only ones that can provide NetBIOS name_type information are:

- WINS — the best tool.
- LMHOSTS — static and hard to maintain.
- Broadcast — uses UDP and cannot resolve names across remote segments.

Alternative means of name resolution include:

- Static `/etc/hosts` — hard to maintain, and lacks name_type info.
- DNS — is a good choice but lacks essential name_type info.

Many sites want to restrict DNS lookups and avoid broadcast name resolution traffic. The *name resolve order* parameter is of great help here. The syntax of the *name resolve order* parameter is: `name resolve order = wins lmhosts bcast host` or `name resolve order = wins lmhosts (eliminates bcast and host)` The default is: `name resolve order = host lmhost wins bcast` where “host” refers to the native methods used by the UNIX system to implement the `gethostbyname()` function call. This is normally controlled by `/etc/host.conf`, `/etc/nsswitch.conf` and `/etc/resolv.conf`.

9.7 Technical Overview of Browsing

SMB networking provides a mechanism by which clients can access a list of machines in a network, a so-called browse list. This list contains machines that are ready to offer file and/or print services to other machines within the network. Thus it does not include machines that aren’t currently able to do server tasks. The browse list is heavily used by all SMB clients. Configuration of SMB browsing has been problematic for some Samba users, hence this document.

MS Windows 2000 and later versions, as with Samba-3 and later versions, can be configured to not use NetBIOS over TCP/IP. When configured this way, it is imperative that name resolution (using DNS/LDAP/ADS) be correctly configured and operative. Browsing will not work if name resolution from SMB machine names to IP addresses does not function correctly.

Where NetBIOS over TCP/IP is enabled, use of a WINS server is highly recommended to aid the resolution of NetBIOS (SMB) names to IP addresses. WINS allows remote segment clients to obtain NetBIOS name.type information that cannot be provided by any other means of name resolution.

9.7.1 Browsing Support in Samba

Samba facilitates browsing. The browsing is supported by `nmbd` and is also controlled by options in the `smb.conf` file. Samba can act as a local browse master for a workgroup and the ability to support domain logons and scripts is now available.

Samba can also act as a Domain Master Browser for a workgroup. This means that it will collate lists from Local Master Browsers into a wide area network server list. In order for browse clients to resolve the names they may find in this list, it is recommended that both Samba and your clients use a WINS server.

Do not set Samba to be the Domain Master for a workgroup that has the same name as an NT Domain. On each wide area network, you must only ever have one Domain Master Browser per workgroup, regardless of whether it is NT, Samba or any other type of domain master that is providing this service.

NOTE



nmbd can be configured as a WINS server, but it is not necessary to specifically use Samba as your WINS server. MS Windows NT4, Server or Advanced Server 200x can be configured as your WINS server. In a mixed NT/200x server and Samba environment on a Wide Area Network, it is recommended that you use the Microsoft WINS server capabilities. In a Samba-only environment, it is recommended that you use one and only one Samba server as the WINS server.

To get browsing to work you need to run `nmbd` as usual, but will need to use the workgroup option in `smb.conf` to control what workgroup Samba becomes a part of.

Samba also has a useful option for a Samba server to offer itself for browsing on another subnet. It is recommended that this option is only used for “*unusual*” purposes: announcements over the Internet, for example. See `remote announce` in the `smb.conf` man page.

9.7.2 Problem Resolution

If something does not work, the `log.nmbd` file will help to track down the problem. Try a log level of 2 or 3 for finding problems. Also note that the current browse list usually gets stored in text form in a file called `browse.dat`.

If it does not work, you should still be able to type the server name as `\\SERVER` in **filemanager**, then press enter and **filemanager** should display the list of available shares.

Some people find browsing fails because they do not have the global guest account set to a valid account. Remember that the IPC\$ connection that lists the shares is done as guest and, thus, you must have a valid guest account.

MS Windows 2000 and later (as with Samba) can be configured to disallow anonymous (i.e., guest account) access to the IPC\$ share. In that case, the MS Windows 2000/XP/2003 machine acting as an SMB/CIFS client will use the name of the currently logged-in user to query the IPC\$ share. MS Windows 9x/Me clients are not able to do this and thus will not be able to browse server resources.

The other big problem people have is that their broadcast address, netmask or IP address is wrong (specified with the interfaces option in `smb.conf`)

9.7.3 Cross-Subnet Browsing

Since the release of Samba 1.9.17 (alpha1), Samba has supported the replication of browse lists across subnet boundaries. This section describes how to set this feature up in different settings.

To see browse lists that span TCP/IP subnets (i.e., networks separated by routers that do not pass broadcast traffic), you must set up at least one WINS server. The WINS server acts as a DNS for NetBIOS names. This will allow NetBIOS name-to-IP address translation to be completed by a direct query of the WINS server. This is done via a directed UDP packet on port 137 to the WINS server machine. The WINS server avoids the necessity of default NetBIOS name-to-IP address translation, which is done using UDP broadcasts from the querying machine. This means that machines on one subnet will not be able to resolve the names of machines on another subnet without using a WINS server.

Remember, for browsing across subnets to work correctly, all machines, be they Windows 95, Windows NT or Samba servers, must have the IP address of a WINS server given to them by a DHCP server, or by manual configuration (for Windows 9x/Me and Windows NT/200x/XP, this is in the TCP/IP Properties, under Network settings); for Samba, this is in the `smb.conf` file.

9.7.3.1 Behavior of Cross-Subnet Browsing

Cross-subnet Browsing is a complicated dance, containing multiple moving parts. It has taken Microsoft several years to get the code that achieves this correct, and Samba lags behind in some areas. Samba is capable of cross-subnet browsing when configured correctly.

Consider a network set up as in Cross-Subnet Browsing Example.

This consists of 3 subnets (1, 2, 3) connected by two routers (R1, R2) which do not pass broadcasts. Subnet 1 has five machines on it, subnet 2 has four machines, subnet 3 has four machines. Assume for the moment that all machines are configured to be in the same workgroup (for simplicity's sake). Machine N1_C on subnet 1 is configured as Domain Master Browser (i.e., it will collate the browse lists for the workgroup). Machine N2_D is configured as WINS server and all the other machines are configured to register their NetBIOS names with it.

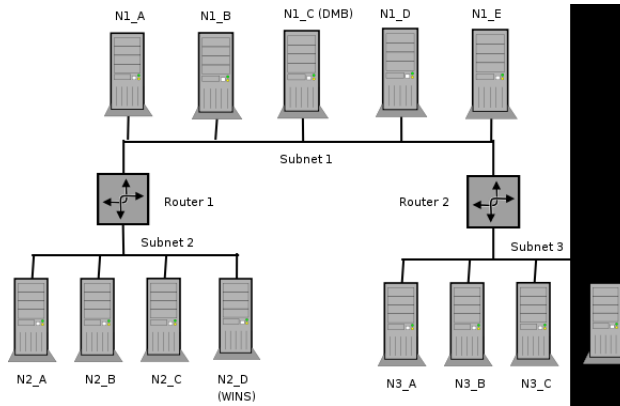

Figure 9.1. Cross-Subnet Browsing Example.

As these machines are booted up, elections for master browsers will take place on each of the three subnets. Assume that machine N1_C wins on subnet 1, N2_B wins on subnet 2, and N3_D wins on subnet 3. These machines are known as Local Master Browsers for their particular subnet. N1_C has an advantage in winning as the Local Master Browser on subnet 1 as it is set up as Domain Master Browser.

On each of the three networks, machines that are configured to offer sharing services will broadcast that they are offering these services. The Local Master Browser on each subnet will receive these broadcasts and keep a record of the fact that the machine is offering a service. This list of records is the basis of the browse list. For this case, assume that all the machines are configured to offer services, so all machines will be on the browse list.

For each network, the Local Master Browser on that network is considered “*authoritative*” for all the names it receives via local broadcast. This is because a machine seen by the Local Master Browser via a local broadcast must be on the same network as the Local Master Browser and thus is a “*trusted*” and “*verifiable*” resource. Machines on other networks that the Local Master Browsers learn about when collating their browse lists have not been directly seen. These records are called “*non-authoritative*.”

At this point the browse lists appear as shown in the next example (these are the machines you would see in your network neighborhood if you looked in it on a particular network right now).

Table 9.1. Browse Subnet Example 1

Subnet	Browse Master	List
Subnet1	N1_C	N1_A, N1_B, N1_C, N1_D, N1_E
Subnet2	N2_B	N2_A, N2_B, N2_C, N2_D
Subnet3	N3_D	N3_A, N3_B, N3_C, N3_D

At this point all the subnets are separate, and no machine is seen across any of the subnets.

Now examine subnet 2. As soon as N2_B has become the Local Master Browser it looks

for a Domain Master Browser with which to synchronize its browse list. It does this by querying the WINS server (N2.D) for the IP address associated with the NetBIOS name WORKGROUP<1B>. This name was registered by the Domain Master Browser (N1.C) with the WINS server as soon as it was started.

Once N2.B knows the address of the Domain Master Browser, it tells it that is the Local Master Browser for subnet 2 by sending a *MasterAnnouncement* packet as a UDP port 138 packet. It then synchronizes with it by doing a *NetServerEnum2* call. This tells the Domain Master Browser to send it all the server names it knows about. Once the Domain Master Browser receives the *MasterAnnouncement* packet, it schedules a synchronization request to the sender of that packet. After both synchronizations are complete the browse lists look as shown in following example:

Table 9.2. Browse Subnet Example 2

Subnet	Browse Master	List
Subnet1	N1.C	N1.A, N1.B, N1.C, N1.D, N1.E, N2.A(*), N2.B(*), N2.C(*), N2.D(*)
Subnet2	N2.B	N2.A, N2.B, N2.C, N2.D, N1.A(*), N1.B(*), N1.C(*), N1.D(*), N1.E(*)
Subnet3	N3.D	N3.A, N3.B, N3.C, N3.D

Servers with an (*) after them are non-authoritative names.

At this point users looking in their network neighborhood on subnets 1 or 2 will see all the servers on both, users on subnet 3 will still only see the servers on their own subnet.

The same sequence of events that occurred for N2.B now occurs for the Local Master Browser on subnet 3 (N3.D). When it synchronizes browse lists with the Domain Master Browser (N1.A) it gets both the server entries on subnet 1, and those on subnet 2. After N3.D has synchronized with N1.C and vica versa, the browse lists will appear as shown in following example.

Table 9.3. Browse Subnet Example 3

Subnet	Browse Master	List
Subnet1	N1.C	N1.A, N1.B, N1.C, N1.D, N1.E, N2.A(*), N2.B(*), N2.C(*), N2.D(*), N3.A(*), N3.B(*), N3.C(*), N3.D(*)
Subnet2	N2.B	N2.A, N2.B, N2.C, N2.D, N1.A(*), N1.B(*), N1.C(*), N1.D(*), N1.E(*)
Subnet3	N3.D	N3.A, N3.B, N3.C, N3.D, N1.A(*), N1.B(*), N1.C(*), N1.D(*), N1.E(*), N2.A(*), N2.B(*), N2.C(*), N2.D(*)

Servers with an (*) after them are non-authoritative names.

At this point, users looking in their network neighborhood on subnets 1 or 3 will see all the servers on all subnets, while users on subnet 2 will still only see the servers on subnets 1 and 2, but not 3.

Finally, the Local Master Browser for subnet 2 (N2.B) will sync again with the Domain Master Browser (N1.C) and will receive the missing server entries. Finally, as when a

steady state (if no machines are removed or shut off) has been achieved, the browse lists will appear as shown in example below.

Table 9.4. Browse Subnet Example 4

Subnet	Browse Master	List
Subnet1	N1_C	N1_A, N1_B, N1_C, N1_D, N1_E, N2_A(*), N2_B(*), N2_C(*), N2_D(*), N3_A(*), N3_B(*), N3_C(*), N3_D(*)
Subnet2	N2_B	N2_A, N2_B, N2_C, N2_D, N1_A(*), N1_B(*), N1_C(*), N1_D(*), N1_E(*), N3_A(*), N3_B(*), N3_C(*), N3_D(*)
Subnet3	N3_D	N3_A, N3_B, N3_C, N3_D, N1_A(*), N1_B(*), N1_C(*), N1_D(*), N1_E(*), N2_A(*), N2_B(*), N2_C(*), N2_D(*)

Servers with an (*) after them are non-authoritative names.

Synchronizations between the Domain Master Browser and Local Master Browsers will continue to occur, but this should remain a steady state operation.

If either router R1 or R2 fails, the following will occur:

1. Names of computers on each side of the inaccessible network fragments will be maintained for as long as 36 minutes in the network neighborhood lists.
2. Attempts to connect to these inaccessible computers will fail, but the names will not be removed from the network neighborhood lists.
3. If one of the fragments is cut off from the WINS server, it will only be able to access servers on its local subnet using subnet-isolated broadcast NetBIOS name resolution. The effects are similar to that of losing access to a DNS server.

9.8 Common Errors

Many questions are asked on the mailing lists regarding browsing. The majority of browsing problems originate from incorrect configuration of NetBIOS name resolution. Some are of particular note.

9.8.1 How Can One Flush the Samba NetBIOS Name Cache without Restarting Samba?

Samba's **nmbd** process controls all browse list handling. Under normal circumstances it is safe to restart **nmbd**. This will effectively flush the Samba NetBIOS name cache and cause it to be rebuilt. This does not make certain that a rogue machine name will not re-appear in the browse list. When **nmbd** is taken out of service, another machine on the network will become the Browse Master. This new list may still have the rogue entry in it. If you really want to clear a rogue machine from the list, every machine on the network will need to be shut down and restarted after all machines are down. Failing a complete restart, the only other thing you can do is wait until the entry times out and is then flushed from the list. This may take a long time on some networks (perhaps months).

9.8.2 Server Resources Can Not Be Listed

“My Client Reports ‘This server is not configured to list shared resources’”

Your guest account is probably invalid for some reason. Samba uses the guest account for browsing in `smbd`. Check that your guest account is valid.

Also see guest account in the `smb.conf` man page.

9.8.3 I get an ‘Unable to browse the network’ error

This error can have multiple causes:

- There is no Local Master Browser. Configure `nmbd` or any other machine to serve as Local Master Browser.
- You cannot log onto the machine that is the local master browser. Can you logon to it as a guest user?
- There is no IP connectivity to the Local Master Browser. Can you reach it by broadcast?

9.8.4 Browsing of Shares and Directories is Very Slow

“There are only two machines on a test network. One a Samba server, the other a Windows XP machine. Authentication and logons work perfectly, but when I try to explore shares on the Samba server, the Windows XP client becomes unresponsive. Sometimes it does not respond for some minutes. Eventually, Windows Explorer will respond and displays files and directories without problem. display file and directory.”

“But, the share is immediately available from a command shell (`cmd`, followed by exploration with `dos` command. Is this a Samba problem or is it a Windows problem? How can I solve this?”

Here are a few possibilities:

Bad Networking Hardware Most common defective hardware problems center around low cost or defective HUBs, routers, Network Interface Controllers (NICs) and bad wiring. If one piece of hardware is defective the whole network may suffer. Bad networking hardware can cause data corruption. Most bad networking hardware problems are accompanied by an increase in apparent network traffic, but not all.

The Windows XP WebClient A number of sites have reported similar slow network browsing problems and found that when the WebClient service is turned off, the problem disappears. This is certainly something that should be explored as it is a simple solution — if it works.

Inconsistent WINS Configuration This type of problem is common when one client is configured to use a WINS server (that is a TCP/IP configuration setting) and there is

no WINS server on the network. Alternately, this will happen if there is a WINS server and Samba is not configured to use it. The use of WINS is highly recommended if the network is using NetBIOS over TCP/IP protocols. If use of NetBIOS over TCP/IP is disabled on all clients, Samba should not be configured as a WINS server neither should it be configured to use one.

Incorrect DNS Configuration If use of NetBIOS over TCP/IP is disabled, Active Directory is in use and the DNS server has been incorrectly configured. Refer DNS and Active Directory for more information.

ACCOUNT INFORMATION DATABASES

Samba-3 implements a new capability to work concurrently with multiple account backends. The possible new combinations of password backends allows Samba-3 a degree of flexibility and scalability that previously could be achieved only with MS Windows Active Directory. This chapter describes the new functionality and how to get the most out of it.

10.1 Features and Benefits

Samba-3 provides for complete backward compatibility with Samba-2.2.x functionality as follows:

10.1.1 Backward Compatibility Backends

Plain Text This option uses nothing but the UNIX/Linux `/etc/passwd` style backend. On systems that have Pluggable Authentication Modules (PAM) support, all PAM modules are supported. The behavior is just as it was with Samba-2.2.x, and the protocol limitations imposed by MS Windows clients apply likewise. Please refer to Technical Information for more information regarding the limitations of Plain Text password usage.

smbpasswd This option allows continued use of the `smbpasswd` file that maintains a plain ASCII (text) layout that includes the MS Windows LanMan and NT encrypted passwords as well as a field that stores some account information. This form of password backend does not store any of the MS Windows NT/200x SAM (Security Account Manager) information required to provide the extended controls that are needed for more comprehensive inter-operation with MS Windows NT4/200x servers.

This backend should be used only for backward compatibility with older versions of Samba. It may be deprecated in future releases.

ldapsam_compat (Samba-2.2 LDAP Compatibility) There is a password backend option that allows continued operation with an existing OpenLDAP backend that uses the Samba-2.2.x LDAP schema extension. This option is provided primarily as a migration tool, although there is no reason to force migration at this time. This tool will eventually be deprecated.

Samba-3 introduces a number of new password backend capabilities.

10.1.2 New Backends

tdbsam This backend provides a rich database backend for local servers. This backend is not suitable for multiple Domain Controllers (i.e., PDC + one or more BDC) installations.

The `tdbsam` password backend stores the old `smbpasswd` information plus the extended MS Windows NT / 200x SAM information into a binary format TDB (trivial database) file. The inclusion of the extended information makes it possible for Samba-3 to implement the same account and system access controls that are possible with MS Windows NT4/200x-based systems.

The inclusion of the `tdbsam` capability is a direct response to user requests to allow simple site operation without the overhead of the complexities of running OpenLDAP. It is recommended to use this only for sites that have fewer than 250 users. For larger sites or implementations, the use of OpenLDAP or of Active Directory integration is strongly recommended.

ldapsam This provides a rich directory backend for distributed account installation.

Samba-3 has a new and extended LDAP implementation that requires configuration of OpenLDAP with a new format Samba schema. The new format schema file is included in the `examples/LDAP` directory of the Samba distribution.

The new LDAP implementation significantly expands the control abilities that were possible with prior versions of Samba. It is now possible to specify “*per user*” profile settings, home directories, account access controls, and much more. Corporate sites will see that the Samba Team has listened to their requests both for capability and to allow greater scalability.

mysqksam (MySQL based backend) It is expected that the MySQL-based SAM will be very popular in some corners. This database backend will be of considerable interest to sites that want to leverage existing MySQL technology.

xmlsam (XML based datafile) Allows the account and password data to be stored in an XML format data file. This backend cannot be used for normal operation, it can only be used in conjunction with **pdbedit**'s `pdb2pdb` functionality. The DTD that is used might be subject to changes in the future.

The `xmlsam` option can be useful for account migration between database backends or backups. Use of this tool will allow the data to be edited before migration into another backend format.

10.2 Technical Information

Old Windows clients send plain text passwords over the wire. Samba can check these passwords by encrypting them and comparing them to the hash stored in the UNIX user database.

Newer Windows clients send encrypted passwords (so-called LanMan and NT hashes) over the wire, instead of plain text passwords. The newest clients will send only encrypted passwords and refuse to send plain text passwords, unless their registry is tweaked.

These passwords can't be converted to UNIX-style encrypted passwords. Because of that, you can't use the standard UNIX user database, and you have to store the LanMan and NT hashes somewhere else.

In addition to differently encrypted passwords, Windows also stores certain data for each user that is not stored in a UNIX user database. For example, workstations the user may logon from, the location where the user's profile is stored, and so on. Samba retrieves and stores this information using a `passdb` backend. Commonly available backends are LDAP, plain text file, and MySQL. For more information, see the man page for `smb.conf` regarding the `passdb` backend parameter.

The resolution of SIDs to UIDs is fundamental to correct operation of Samba. In both cases shown, if `winbindd` is not running, or cannot be contacted, then only local SID/UID resolution is possible. See resolution of SIDs to UIDs and resolution of UIDs to SIDs diagrams.

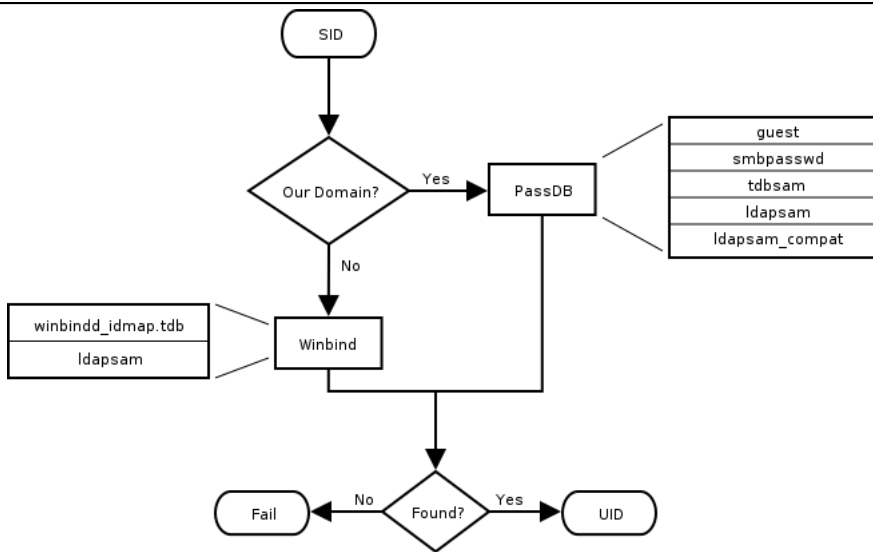

Figure 10.1. IDMAP: Resolution of SIDs to UIDs.

10.2.1 Important Notes About Security

The UNIX and SMB password encryption techniques seem similar on the surface. This similarity is, however, only skin deep. The UNIX scheme typically sends clear-text passwords over the network when logging in. This is bad. The SMB encryption scheme never sends the clear-text password over the network but it does store the 16 byte hashed values on disk. This is also bad. Why? Because the 16 byte hashed values are a “*password equivalent*.” You cannot derive the user’s password from them, but they could potentially be used in a modified client to gain access to a server. This would require considerable technical knowledge on behalf of the attacker but is perfectly possible. You should thus treat the data stored in whatever passwd backend you use (smbpasswd file, LDAP, MYSQL) as though it contained the clear-text passwords of all your users. Its contents must be kept secret and the file should be protected accordingly.

Ideally, we would like a password scheme that involves neither plain text passwords on the network nor on disk. Unfortunately, this is not available as Samba is stuck with having to be compatible with other SMB systems (Windows NT, Windows for Workgroups, Windows 9x/Me).

Windows NT 4.0 Service Pack 3 changed the default setting so plaintext passwords are disabled from being sent over the wire. This mandates either the use of encrypted password support or editing the Windows NT registry to re-enable plaintext passwords.

The following versions of Microsoft Windows do not support full domain security protocols, although they may log onto a domain environment:

- MS DOS Network client 3.0 with the basic network redirector installed.
- Windows 95 with the network redirector update installed.

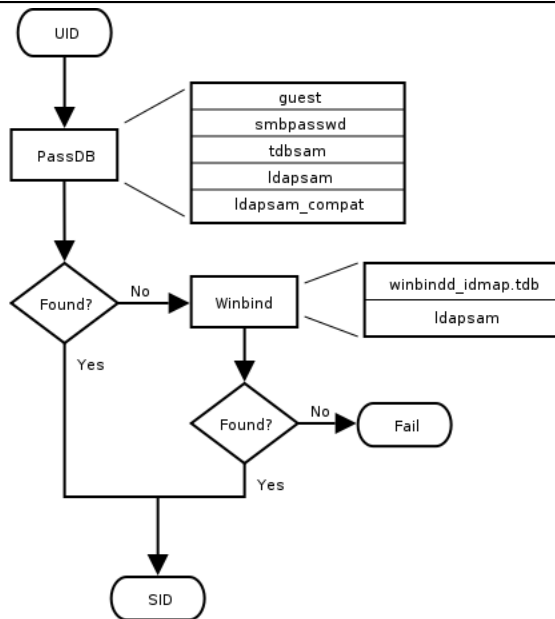

Figure 10.2. IDMAP: Resolution of UIDs to SIDs.

- Windows 98 [Second Edition].
- Windows Me.

NOTE



MS Windows XP Home does not have facilities to become a Domain Member and it cannot participate in domain logons.

The following versions of MS Windows fully support domain security protocols.

- Windows NT 3.5x.
- Windows NT 4.0.
- Windows 2000 Professional.
- Windows 200x Server/Advanced Server.
- Windows XP Professional.

All current releases of Microsoft SMB/CIFS clients support authentication via the SMB Challenge/Response mechanism described here. Enabling clear-text authentication does not disable the ability of the client to participate in encrypted authentication. Instead, it

allows the client to negotiate either plain text or encrypted password handling.

MS Windows clients will cache the encrypted password alone. Where plain text passwords are re-enabled through the appropriate registry change, the plain text password is never cached. This means that in the event that a network connections should become disconnected (broken), only the cached (encrypted) password will be sent to the resource server to effect an auto-reconnect. If the resource server does not support encrypted passwords the auto-reconnect will fail. Use of encrypted passwords is strongly advised.

10.2.1.1 Advantages of Encrypted Passwords

- Plaintext passwords are not passed across the network. Someone using a network sniffer cannot just record passwords going to the SMB server.
- Plaintext passwords are not stored anywhere in memory or on disk.
- Windows NT does not like talking to a server that does not support encrypted passwords. It will refuse to browse the server if the server is also in User Level security mode. It will insist on prompting the user for the password on each connection, which is very annoying. The only things you can do to stop this is to use SMB encryption.
- Encrypted password support allows automatic share (resource) reconnects.
- Encrypted passwords are essential for PDC/BDC operation.

10.2.1.2 Advantages of Non-Encrypted Passwords

- Plaintext passwords are not kept on disk, and are not cached in memory.
- Uses same password file as other UNIX services such as Login and FTP.
- Use of other services (such as Telnet and FTP) that send plain text passwords over the network, so sending them for SMB is not such a big deal.

10.2.2 Mapping User Identifiers between MS Windows and UNIX

Every operation in UNIX/Linux requires a user identifier (UID), just as in MS Windows NT4/200x this requires a Security Identifier (SID). Samba provides two means for mapping an MS Windows user to a UNIX/Linux UID.

First, all Samba SAM (Security Account Manager database) accounts require a UNIX/Linux UID that the account will map to. As users are added to the account information database, Samba will call the add user script interface to add the account to the Samba host OS. In essence all accounts in the local SAM require a local user account.

The second way to effect Windows SID to UNIX UID mapping is via the *idmap uid* and *idmap gid* parameters in `smb.conf`. Please refer to the man page for information about these parameters. These parameters are essential when mapping users from a remote SAM server.

10.2.3 Mapping Common UIDs/GIDs on Distributed Machines

Samba-3 has a special facility that makes it possible to maintain identical UIDs and GIDs on all servers in a distributed network. A distributed network is one where there exists a PDC, one or more BDCs and/or one or more Domain Member servers. Why is this important? This is important if files are being shared over more than one protocol (e.g., NFS) and where users are copying files across UNIX/Linux systems using tools such as **rsync**.

The special facility is enabled using a parameter called *idmap backend*. The default setting for this parameter is an empty string. Technically it is possible to use an LDAP based idmap backend for UIDs and GIDs, but it makes most sense when this is done for network configurations that also use LDAP for the SAM backend. Following example shows that.

Example 10.2.1. Example configuration with the LDAP idmap backend

```
[global]
    idmap backend = ldap:ldap://ldap-server.kenya.org:636
    idmap backend = ldap:ldaps://ldap-server.kenya.org
```

A network administrator who wants to make significant use of LDAP backends will sooner or later be exposed to the excellent work done by PADL Software. PADL <<http://www.padl.com>> have produced and released to open source an array of tools that might be of interest. These tools include:

- *nss_ldap*: An LDAP Name Service Switch module to provide native name service support for AIX, Linux, Solaris, and other operating systems. This tool can be used for centralized storage and retrieval of UIDs/GIDs.
- *pam_ldap*: A PAM module that provides LDAP integration for UNIX/Linux system access authentication.
- *idmap_ad*: An IDMAP backend that supports the Microsoft Services for UNIX RFC 2307 schema available from their web site <http://www.padl.com/download/xad_oss_plugins.tar.gz>.

10.3 Account Management Tools

Samba provides two tools for management of user and machine accounts. These tools are called **smbpasswd** and **pdbedit**.

10.3.1 The *smbpasswd* Command

The **smbpasswd** utility is similar to the **passwd** or **yppasswd** programs. It maintains the two 32 byte password fields in the **passwd** backend.

smbpasswd works in a client-server mode where it contacts the local **smbd** to change the user's password on its behalf. This has enormous benefits.

smbpasswd has the capability to change passwords on Windows NT servers (this only works when the request is sent to the NT Primary Domain Controller if changing an NT Domain user's password).

smbpasswd can be used to:

- *add* user or machine accounts.
- *delete* user or machine accounts.
- *enable* user or machine accounts.
- *disable* user or machine accounts.
- *set to NULL* user passwords.
- *manage interdomain trust accounts*.

To run **smbpasswd** as a normal user just type:

```
$ smbpasswd
Old SMB password: secret
```

For *secret*, type old value here or press return if there is no old password.

```
New SMB Password: new secret
Repeat New SMB Password: new secret
```

If the old value does not match the current value stored for that user, or the two new values do not match each other, then the password will not be changed.

When invoked by an ordinary user, the command will only allow the user to change his or her own SMB password.

When run by root, **smbpasswd** may take an optional argument specifying the user name whose SMB password you wish to change. When run as root, **smbpasswd** does not prompt for or check the old password value, thus allowing root to set passwords for users who have forgotten their passwords.

smbpasswd is designed to work in the way familiar to UNIX users who use the **passwd** or **yppasswd** commands. While designed for administrative use, this tool provides essential User Level password change capabilities.

For more details on using **smbpasswd**, refer to the man page (the definitive reference).

10.3.2 The *pdbedit* Command

pdbedit is a tool that can be used only by root. It is used to manage the **passdb** backend. **pdbedit** can be used to:

- add, remove or modify user accounts.

- list user accounts.
- migrate user accounts.

The **pdbedit** tool is the only one that can manage the account security and policy settings. It is capable of all operations that `smbpasswd` can do as well as a super set of them.

One particularly important purpose of the **pdbedit** is to allow the migration of account information from one `passwd` backend to another. See the XML password backend section of this chapter.

The following is an example of the user account information that is stored in a `tdbsam` password backend. This listing was produced by running:

```
$ pdbedit -Lv met
UNIX username:      met
NT username:
Account Flags:      [UX          ]
User SID:           S-1-5-21-1449123459-1407424037-3116680435-2004
Primary Group SID: S-1-5-21-1449123459-1407424037-3116680435-1201
Full Name:          Melissa E Terpstra
Home Directory:     \\frodo\met\Win9Profile
HomeDir Drive:      H:
Logon Script:       scripts\logon.bat
Profile Path:       \\frodo\Profiles\met
Domain:             MIDEARTH
Account desc:
Workstations:       melbelle
Munged dial:
Logon time:         0
Logoff time:        Mon, 18 Jan 2038 20:14:07 GMT
Kickoff time:       Mon, 18 Jan 2038 20:14:07 GMT
Password last set:  Sat, 14 Dec 2002 14:37:03 GMT
Password can change: Sat, 14 Dec 2002 14:37:03 GMT
Password must change: Mon, 18 Jan 2038 20:14:07 GMT
```

The **pdbedit** tool allows migration of authentication (account) databases from one backend to another. For example: To migrate accounts from an old `smbpasswd` database to a `tdbsam` backend:

1. Set the `passwd` backend = `tdbsam`, `smbpasswd`.
2. Execute:

```
root# pdbedit -i smbpasswd -e tdbsam
```

3. Now remove the `smbpasswd` from the `passwd` backend configuration in `smb.conf`.

10.4 Password Backends

Samba offers the greatest flexibility in backend account database design of any SMB/CIFS server technology available today. The flexibility is immediately obvious as one begins to explore this capability.

It is possible to specify not only multiple different password backends, but even multiple backends of the same type. For example, to use two different `tdbsam` databases:

```
passdb backend = tdbsam:/etc/samba/passdb.tdb \  
tdbsam:/etc/samba/old-passdb.tdb
```

10.4.1 Plaintext

Older versions of Samba retrieved user information from the UNIX user database and eventually some other fields from the file `/etc/samba/smbpasswd` or `/etc/smbpasswd`. When password encryption is disabled, no SMB specific data is stored at all. Instead all operations are conducted via the way that the Samba host OS will access its `/etc/passwd` database. Linux systems For example, all operations are done via PAM.

10.4.2 smbpasswd — Encrypted Password Database

Traditionally, when configuring `encrypt passwords = yes` in Samba's `smb.conf` file, user account information such as username, LM/NT password hashes, password change times, and account flags have been stored in the `smbpasswd(5)` file. There are several disadvantages to this approach for sites with large numbers of users (counted in the thousands).

- The first problem is that all lookups must be performed sequentially. Given that there are approximately two lookups per domain logon (one for a normal session connection such as when mapping a network drive or printer), this is a performance bottleneck for large sites. What is needed is an indexed approach such as used in databases.
- The second problem is that administrators who desire to replicate a `smbpasswd` file to more than one Samba server were left to use external tools such as `rsync(1)` and `ssh(1)` and wrote custom, in-house scripts.
- Finally, the amount of information that is stored in an `smbpasswd` entry leaves no room for additional attributes such as a home directory, password expiration time, or even a Relative Identifier (RID).

As a result of these deficiencies, a more robust means of storing user attributes used by `smbd` was developed. The API which defines access to user accounts is commonly referred to as the `samdb` interface (previously this was called the `passdb` API, and is still so named in the Samba CVS trees).

Samba provides an enhanced set of `passdb` backends that overcome the deficiencies of the `smbpasswd` plain text database. These are `tdbsam`, `ldapsam` and `xmsam`. Of these, `ldapsam` will be of most interest to large corporate or enterprise sites.

10.4.3 tdbsam

Samba can store user and machine account data in a “*TDB*” (Trivial Database). Using this backend does not require any additional configuration. This backend is recommended for new installations that do not require LDAP.

As a general guide, the Samba Team does not recommend using the tdbsam backend for sites that have 250 or more users. Additionally, tdbsam is not capable of scaling for use in sites that require PDB/BDC implementations that require replication of the account database. Clearly, for reason of scalability, the use of ldapsam should be encouraged.

The recommendation of a 250 user limit is purely based on the notion that this would generally involve a site that has routed networks, possibly spread across more than one physical location. The Samba Team has not at this time established the performance based scalability limits of the tdbsam architecture.

10.4.4 ldapsam

There are a few points to stress that the ldapsam does not provide. The LDAP support referred to in this documentation does not include:

- A means of retrieving user account information from an Windows 200x Active Directory server.
- A means of replacing `/etc/passwd`.

The second item can be accomplished by using LDAP NSS and PAM modules. LGPL versions of these libraries can be obtained from PADL Software <<http://www.padl.com/>>. More information about the configuration of these packages may be found at *LDAP, System Administration*; Gerald Carter by O'Reilly; Chapter 6: Replacing NIS.” <<http://safari.oreilly.com/?xmlId=1-56592-491-6>>

This document describes how to use an LDAP directory for storing Samba user account information traditionally stored in the `smbpasswd(5)` file. It is assumed that the reader already has a basic understanding of LDAP concepts and has a working directory server already installed. For more information on LDAP architectures and directories, please refer to the following sites:

- OpenLDAP <<http://www.openldap.org/>>
- Sun iPlanet Directory Server <<http://iplanet.netscape.com/directory>>

Two additional Samba resources which may prove to be helpful are:

- The Samba-PDC-LDAP-HOWTO <<http://www.unav.es/cti/ldap-smb/ldap-smb-3-howto.html>> maintained by Ignacio Coupeau.
- The NT migration scripts from IDEALX <<http://samba.idealx.org/>> that are geared to manage users and group in such a Samba-LDAP Domain Controller configuration.

10.4.4.1 Supported LDAP Servers

The LDAP `ldapsam` code has been developed and tested using the OpenLDAP 2.0 and 2.1 server and client libraries. The same code should work with Netscape's Directory Server and client SDK. However, there are bound to be compile errors and bugs. These should not be hard to fix. Please submit fixes via the process outlined in Reporting Bugs chapter.

10.4.4.2 Schema and Relationship to the RFC 2307 `posixAccount`

Samba-3.0 includes the necessary schema file for OpenLDAP 2.0 in `examples/LDAP/samba.schema`. The `sambaSamAccount` ObjectClass is given here:

```
ObjectClass (1.3.6.1.4.1.7165.2.2.6 NAME 'sambaSamAccount' SUP top AUXILIARY
  DESC 'Samba-3.0 Auxiliary SAM Account'
  MUST ( uid $ sambaSID )
  MAY ( cn $ sambaLMPassword $ sambaNTPassword $ sambaPwdLastSet $
        sambaLogonTime $ sambaLogoffTime $ sambaKickoffTime $
        sambaPwdCanChange $ sambaPwdMustChange $ sambaAcctFlags $
        displayName $ sambaHomePath $ sambaHomeDrive $ sambaLogonScript $
        sambaProfilePath $ description $ sambaUserWorkstations $
        sambaPrimaryGroupSID $ sambaDomainName ))
```

The `samba.schema` file has been formatted for OpenLDAP 2.0/2.1. The Samba Team owns the OID space used by the above schema and recommends its use. If you translate the schema to be used with Netscape DS, please submit the modified schema file as a patch to jerry@samba.org <<mailto:jerry@samba.org>>.

Just as the `smbpasswd` file is meant to store information that provides information additional to a user's `/etc/passwd` entry, so is the `sambaSamAccount` object meant to supplement the UNIX user account information. A `sambaSamAccount` is a `AUXILIARY` ObjectClass so it can be used to augment existing user account information in the LDAP directory, thus providing information needed for Samba account handling. However, there are several fields (e.g., `uid`) that overlap with the `posixAccount` ObjectClass outlined in RFC2307. This is by design.

In order to store all user account information (UNIX and Samba) in the directory, it is necessary to use the `sambaSamAccount` and `posixAccount` ObjectClasses in combination. However, `smbd` will still obtain the user's UNIX account information via the standard C library calls (e.g., `getpwnam()`, et al). This means that the Samba server must also have the LDAP NSS library installed and functioning correctly. This division of information makes it possible to store all Samba account information in LDAP, but still maintain UNIX account information in NIS while the network is transitioning to a full LDAP infrastructure.

10.4.4.3 OpenLDAP Configuration

To include support for the `sambaSamAccount` object in an OpenLDAP directory server, first copy the `samba.schema` file to `slapd`'s configuration directory. The `samba.schema` file can be found in the directory `examples/LDAP` in the Samba source distribution.

```
root# cp samba.schema /etc/openldap/schema/
```

Next, include the `samba.schema` file in `slapd.conf`. The `sambaSamAccount` object contains two attributes that depend on other schema files. The `uid` attribute is defined in `cosine.schema` and the `displayName` attribute is defined in the `inetorgperson.schema` file. Both of these must be included before the `samba.schema` file.

```
## /etc/openldap/slapd.conf

## schema files (core.schema is required by default)
include          /etc/openldap/schema/core.schema

## needed for sambaSamAccount
include          /etc/openldap/schema/cosine.schema
include          /etc/openldap/schema/inetorgperson.schema
include          /etc/openldap/schema/nis.schema
include          /etc/openldap/schema/samba.schema
....
```

It is recommended that you maintain some indices on some of the most useful attributes, as in the following example, to speed up searches made on `sambaSamAccount` objectclasses (and possibly `posixAccount` and `posixGroup` as well):

```
# Indices to maintain
## required by OpenLDAP
index objectclass          eq

index cn                   pres,sub,eq
index sn                   pres,sub,eq
## required to support pdb_getsampwnam
index uid                  pres,sub,eq
## required to support pdb_getsambapwrid()
index displayName          pres,sub,eq

## uncomment these if you are storing posixAccount and
## posixGroup entries in the directory as well
##index uidNumber          eq
##index gidNumber          eq
##index memberUid          eq

index sambaSID              eq
index sambaPrimaryGroupSID eq
index sambaDomainName      eq
index default               sub
```

Create the new index by executing:

```
root# ./sbin/slapindex -f slapd.conf
```

Remember to restart slapd after making these changes:

```
root# /etc/init.d/slapd restart
```

10.4.4.4 Initialize the LDAP Database

Before you can add accounts to the LDAP database you must create the account containers that they will be stored in. The following LDIF file should be modified to match your needs (DNS entries, and so on):

```
# Organization for Samba Base
dn: dc=quenia,dc=org
objectclass: dcObject
objectclass: organization
dc: quenia
o: Quenia Org Network
description: The Samba-3 Network LDAP Example

# Organizational Role for Directory Management
dn: cn=Manager,dc=quenia,dc=org
objectclass: organizationalRole
cn: Manager
description: Directory Manager

# Setting up container for users
dn: ou=People,dc=quenia,dc=org
objectclass: top
objectclass: organizationalUnit
ou: People

# Setting up admin handle for People OU
dn: cn=admin,ou=People,dc=quenia,dc=org
cn: admin
objectclass: top
objectclass: organizationalRole
objectclass: simpleSecurityObject
userPassword: {SSHA}c3ZM9tBaBo9autm1dL3waDS21+JSfQVz

# Setting up container for groups
dn: ou=Groups,dc=quenia,dc=org
```

```
objectclass: top
objectclass: organizationalUnit
ou: Groups

# Setting up admin handle for Groups OU
dn: cn=admin,ou=Groups,dc=kenya,dc=org
cn: admin
objectclass: top
objectclass: organizationalRole
objectclass: simpleSecurityObject
userPassword: {SSHA}c3ZM9tBaBo9autm1dL3waDS21+JSfQVz

# Setting up container for computers
dn: ou=Computers,dc=kenya,dc=org
objectclass: top
objectclass: organizationalUnit
ou: Computers

# Setting up admin handle for Computers OU
dn: cn=admin,ou=Computers,dc=kenya,dc=org
cn: admin
objectclass: top
objectclass: organizationalRole
objectclass: simpleSecurityObject
userPassword: {SSHA}c3ZM9tBaBo9autm1dL3waDS21+JSfQVz
```

The userPassword shown above should be generated using **slappasswd**.

The following command will then load the contents of the LDIF file into the LDAP database.

```
$ slapadd -v -l initldap.dif
```

Do not forget to secure your LDAP server with an adequate access control list as well as an admin password.

NOTE



Before Samba can access the LDAP server you need to store the LDAP admin password into the Samba-3 `secrets.tdb` database by:

```
root# smbpasswd -w secret
```

10.4.4.5 Configuring Samba

The following parameters are available in `smb.conf` only if your version of Samba was built with LDAP support. Samba automatically builds with LDAP support if the LDAP libraries are found.

LDAP related `smb.conf` options: `passdb backend = ldapsam:url`, `ldap admin dn`, `ldap delete dn`, `ldap filter`, `ldap group suffix`, `ldap idmap suffix`, `ldap machine suffix`, `ldap passwd sync`, `ldap ssl`, `ldap suffix`, `ldap user suffix`,

These are described in the `smb.conf` man page and so will not be repeated here. However, a sample `smb.conf` file for use with an LDAP directory could appear as shown below.

Example 10.4.1. Configuration with LDAP

```
[global]
    security = user
    encrypt passwords = yes
    netbios name = MORIA
    workgroup = NOLDOR
# ldap related parameters
# define the DN to use when binding to the directory servers
# The password for this DN is not stored in smb.conf. Rather it
# must be set by using 'smbpasswd -w secretpw' to store the
# passphrase in the secrets.tdb file. If the "ldap admin dn" values
# change, this password will need to be reset.
    ldap admin dn = "cn=Manager,dc=kenya,dc=org"
# Define the SSL option when connecting to the directory
# ('off', 'start tls', or 'on' (default))
    ldap ssl = start tls
# syntax: passdb backend = ldapsam:ldap://server-name[:port]
    passdb backend = ldapsam:ldap://frodo.kenya.org
# smbpasswd -x delete the entire dn-entry
    ldap delete dn = no
# the machine and user suffix added to the base suffix
# wrote WITHOUT quotes. NULL suffixes by default
    ldap user suffix = ou=People
    ldap group suffix = ou=Groups
    ldap machine suffix = ou=Computers
# Trust UNIX account information in LDAP
# (see the smb.conf man page for details)
# specify the base DN to use when searching the directory
    ldap suffix = dc=kenya,dc=org
# generally the default ldap search filter is ok
    ldap filter = (uid=%u)
```

10.4.4.6 Accounts and Groups Management

As user accounts are managed through the `sambaSamAccount` objectclass, you should modify your existing administration tools to deal with `sambaSamAccount` attributes.

Machine accounts are managed with the `sambaSamAccount` objectclass, just like users accounts. However, it is up to you to store those accounts in a different tree of your LDAP namespace. You should use “`ou=Groups,dc=quenya,dc=org`” to store groups and “`ou=People,dc=quenya,dc=org`” to store users. Just configure your NSS and PAM accordingly (usually, in the `/etc/openldap/sldap.conf` configuration file).

In Samba-3, the group management system is based on POSIX groups. This means that Samba makes use of the `posixGroup` objectclass. For now, there is no NT-like group system management (global and local groups). Samba-3 knows only about **Domain Groups** and, unlike MS Windows 2000 and Active Directory, Samba-3 does not support nested groups.

10.4.4.7 Security and `sambaSamAccount`

There are two important points to remember when discussing the security of `sambaSamAccount` entries in the directory.

- *Never* retrieve the `SambaLMPassword` or `SambaNTPassword` attribute values over an unencrypted LDAP session.
- *Never* allow non-admin users to view the `SambaLMPassword` or `SambaNTPassword` attribute values.

These password hashes are clear-text equivalents and can be used to impersonate the user without deriving the original clear-text strings. For more information on the details of LM/NT password hashes, refer to the Account Information Database section of this chapter.

To remedy the first security issue, the `ldap ssl smb.conf` parameter defaults to require an encrypted session (`ldap ssl = on`) using the default port of 636 when contacting the directory server. When using an OpenLDAP server, it is possible to use the StartTLS LDAP extended operation in the place of LDAPS. In either case, you are strongly discouraged to disable this security (`ldap ssl = off`).

Note that the LDAPS protocol is deprecated in favor of the LDAPv3 StartTLS extended operation. However, the OpenLDAP library still provides support for the older method of securing communication between clients and servers.

The second security precaution is to prevent non-administrative users from harvesting password hashes from the directory. This can be done using the following ACL in `slapd.conf`:

```
## allow the "ldap admin dn" access, but deny everyone else
access to attrs=SambaLMPassword,SambaNTPassword
    by dn="cn=Samba Admin,ou=People,dc=quenya,dc=org" write
    by * none
```

10.4.4.8 LDAP Special Attributes for sambaSamAccounts

The sambaSamAccount objectclass is composed of the attributes shown in next tables: Part A, and Part B.

The majority of these parameters are only used when Samba is acting as a PDC of a domain (refer to Domain Control, for details on how to configure Samba as a Primary Domain Controller). The following four attributes are only stored with the sambaSamAccount entry if the values are non-default values:

- sambaHomePath
- sambaLogonScript
- sambaProfilePath
- sambaHomeDrive

These attributes are only stored with the sambaSamAccount entry if the values are non-default values. For example, assume MORIA has now been configured as a PDC and that logon home = `\\%L\%u` was defined in its `smb.conf` file. When a user named “*becky*” logons to the domain, the logon home string is expanded to `\\MORIA\becky`. If the `smbHome` attribute exists in the entry “*uid=becky,ou=People,dc=samba,dc=org*”, this value is used. However, if this attribute does not exist, then the value of the logon home parameter is used in its place. Samba will only write the attribute value to the directory entry if the value is something other than the default (e.g., `\\MOBY\becky`).

10.4.4.9 Example LDIF Entries for a sambaSamAccount

The following is a working LDIF that demonstrates the use of the SambaSamAccount objectclass:

```
dn: uid=guest2, ou=People,dc=kenya,dc=org
sambaLMPassword: 878D8014606CDA29677A44EFA1353FC7
sambaPwdMustChange: 2147483647
sambaPrimaryGroupSID: S-1-5-21-2447931902-1787058256-3961074038-513
sambaNTPassword: 552902031BEDE9EFAAD3B435B51404EE
sambaPwdLastSet: 1010179124
sambaLogonTime: 0
objectClass: sambaSamAccount
uid: guest2
sambaKickoffTime: 2147483647
sambaAcctFlags: [UX      ]
sambaLogoffTime: 2147483647
sambaSID: S-1-5-21-2447931902-1787058256-3961074038-5006
sambaPwdCanChange: 0
```

The following is an LDIF entry for using both the sambaSamAccount and posixAccount objectclasses:

```
dn: uid=gcarter, ou=People,dc=kenya,dc=org
sambaLogonTime: 0
displayName: Gerald Carter
sambaLMPassword: 552902031BEDE9EFAAD3B435B51404EE
sambaPrimaryGroupSID: S-1-5-21-2447931902-1787058256-3961074038-1201
objectClass: posixAccount
objectClass: sambaSamAccount
sambaAcctFlags: [UX          ]
userPassword: {crypt}BpM2ej8Rkzogo
uid: gcarter
uidNumber: 9000
cn: Gerald Carter
loginShell: /bin/bash
logoffTime: 2147483647
gidNumber: 100
sambaKickoffTime: 2147483647
sambaPwdLastSet: 1010179230
sambaSID: S-1-5-21-2447931902-1787058256-3961074038-5004
homeDirectory: /home/moria/gcarter
sambaPwdCanChange: 0
sambaPwdMustChange: 2147483647
sambaNTPassword: 878D8014606CDA29677A44EFA1353FC7
```

10.4.4.10 Password Synchronization

Samba-3 and later can update the non-samba (LDAP) password stored with an account. When using `pam_ldap`, this allows changing both UNIX and Windows passwords at once.

The `ldap passwd sync` options can have the values shown in the next table.

More information can be found in the `smb.conf` man page.

10.4.5 MySQL

Every so often someone will come along with a great new idea. Storing user accounts in a SQL backend is one of them. Those who want to do this are in the best position to know what the specific benefits are to them. This may sound like a cop-out, but in truth we cannot attempt to document every little detail why certain things of marginal utility to the bulk of Samba users might make sense to the rest. In any case, the following instructions should help the determined SQL user to implement a working system.

10.4.5.1 Creating the Database

You can set up your own table and specify the field names to `pdb_mysql` (see below for the column names) or use the default table. The file `examples/pdb/mysql/mysql.dump` contains the correct queries to create the required tables. Use the command:

```
$ mysql -username -hostname -ppassword \  
    databasename < /path/to/samba/examples/pdb/mysql/mysql.dump
```

10.4.5.2 Configuring

This plug-in lacks some good documentation, but here is some brief information. Add the following to the `passdb backend` variable in your `smb.conf`: `passdb backend = [other-plugins]`

The identifier can be any string you like, as long as it does not collide with the identifiers of other plugins or other instances of `pdb_mysql`. If you specify multiple `pdb_mysql.so` entries in `passdb backend`, you also need to use different identifiers.

Additional options can be given through the `smb.conf` file in the `[global]` section. Refer to the following table.

WARNING

Since the password for the MySQL user is stored in the `smb.conf` file, you should make the `smb.conf` file readable only to the user who runs Samba. This is considered a security bug and will soon be fixed.

Names of the columns are given in the next table. The default column names can be found in the example table dump.

You can put a colon (:) after the name of each column, which should specify the column to update when updating the table. One can also specify nothing behind the colon, in which case the field data will not be updated. Setting a column name to `NULL` means the field should not be used.

An example configuration looks like:

10.4.5.3 Using Plaintext Passwords or Encrypted Password

I strongly discourage the use of plaintext passwords, however, you can use them.

If you would like to use plaintext passwords, set 'identifier:lanman pass column' and 'identifier:nt pass column' to 'NULL' (without the quotes) and 'identifier:plain pass column' to the name of the column containing the plaintext passwords.

If you use encrypted passwords, set the 'identifier:plain pass column' to 'NULL' (without the quotes). This is the default.

Example 10.4.2. Example configuration for the MySQL passdb backend

```
[global]
    passdb backend = mysql:foo
    foo:mysql user = samba
    foo:mysql password = abmas
    foo:mysql database = samba
# domain name is static and can't be changed
    foo:domain column = 'MYWORKGROUP':
# The fullname column comes from several other columns
    foo:fullname column = CONCAT(firstname,' ',surname):
# Samba should never write to the password columns
    foo:lanman pass column = lm_pass:
    foo:nt pass column = nt_pass:
# The unknown 3 column is not stored
    foo:unknown 3 column = NULL
```

10.4.5.4 Getting Non-Column Data from the Table

It is possible to have not all data in the database by making some ‘constant’.

For example, you can set ‘identifier:fullname column’ to something like **CONCAT(Firstname,’’,Surname)**

Or, set ‘identifier:workstations column’ to: **NULL**

See the MySQL documentation for more language constructs.

10.4.6 XML

This module requires libxml2 to be installed.

The usage of `pdb_xml` is fairly straightforward. To export data, use:

```
$ pdbedit -e xml:filename
```

(where filename is the name of the file to put the data in)

To import data, use: `$ pdbedit -i xml:filename`

10.5 Common Errors

10.5.1 Users Cannot Logon

“I’ve installed Samba, but now I can’t log on with my UNIX account!”

Make sure your user has been added to the current Samba passdb backend. Read the section Account Management Tools for details.

10.5.2 Users Being Added to the Wrong Backend Database

A few complaints have been received from users that just moved to Samba-3. The following `smb.conf` file entries were causing problems, new accounts were being added to the old `smbpasswd` file, not to the `tdbsam` `passdb.tdb` file:

```
[global]
...
    passdb backend = smbpasswd, tdbsam
...
```

Samba will add new accounts to the first entry in the `passdb backend` parameter entry. If you want to update to the `tdbsam`, then change the entry to:

```
passdb backend = tdbsam, smbpasswd
```

10.5.3 Configuration of auth methods

When explicitly setting an auth methods parameter, `guest` must be specified as the first entry on the line, for example, `auth methods = guest sam`.

This is the exact opposite of the requirement for the `passdb` backend option, where it must be the *LAST* parameter on the line.

Table 10.1. Attributes in the `sambaSamAccount` objectclass (LDAP) — Part A

<code>sambaLMPassword</code>	The LANMAN password 16-byte hash stored as a character representation of a hexadecimal string.
<code>sambaNTPassword</code>	The NT password hash 16-byte stored as a character representation of a hexadecimal string.
<code>sambaPwdLastSet</code>	The integer time in seconds since 1970 when the <code>sambaLMPassword</code> and <code>sambaNTPassword</code> attributes were last set.
<code>sambaAcctFlags</code>	String of 11 characters surrounded by square brackets [] representing account flags such as U (user), W (workstation), X (no password expiration), I (Domain trust account), H (Home dir required), S (Server trust account), and D (disabled).
<code>sambaLogonTime</code>	Integer value currently unused
<code>sambaLogoffTime</code>	Integer value currently unused
<code>sambaKickoffTime</code>	Specifies the time (UNIX time format) when the user will be locked down and cannot login any longer. If this attribute is omitted, then the account will never expire. If you use this attribute together with ‘shadowExpire’ of the ‘shadowAccount’ objectClass, will enable accounts to expire completely on an exact date.
<code>sambaPwdCanChange</code>	Specifies the time (UNIX time format) from which on the user is allowed to change his password. If attribute is not set, the user will be free to change his password whenever he wants.
<code>sambaPwdMustChange</code>	Specifies the time (UNIX time format) since when the user is forced to change his password. If this value is set to ‘0’, the user will have to change his password at first login. If this attribute is not set, then the password will never expire.
<code>sambaHomeDrive</code>	Specifies the drive letter to which to map the UNC path specified by <code>sambaHomePath</code> . The drive letter must be specified in the form “X.” where X is the letter of the drive to map. Refer to the “ <i>logon drive</i> ” parameter in the <code>smb.conf(5)</code> man page for more information.
<code>sambaLogonScript</code>	The <code>sambaLogonScript</code> property specifies the path of the user’s logon script, .CMD, .EXE, or .BAT file. The string can be null. The path is relative to the netlogon share. Refer to the logon script parameter in the <code>smb.conf</code> man page for more information.
<code>sambaProfilePath</code>	Specifies a path to the user’s profile. This value can be a null string, a local absolute path, or a UNC path. Refer to the logon path parameter in the <code>smb.conf</code> man page for more information.
<code>sambaHomePath</code>	The <code>sambaHomePath</code> property specifies the path of the home directory for the user. The string can be null. If <code>sambaHomeDrive</code> is set and specifies a drive letter, <code>sambaHomePath</code> should be a UNC path. The path must be a network UNC path of the form <code>\\server\share\directory</code> . This value can be a null string. Refer to the logon home parameter in the <code>smb.conf</code> man page for more information.

Table 10.2. Attributes in the sambaSamAccount objectclass (LDAP) — Part B

sambaUserWorkstations	Here you can give a comma-separated list of machines on which the user is allowed to login. You may observe problems when you try to connect to an Samba Domain Member. Because Domain Members are not in this list, the Domain Controllers will reject them. Where this attribute is omitted, the default implies no restrictions.
sambaSID	The security identifier(SID) of the user. The Windows equivalent of UNIX UIDs.
sambaPrimaryGroupSID	The Security IDentifier (SID) of the primary group of the user.
sambaDomainName	Domain the user is part of.

Table 10.3. Possible *ldap passwd sync* values

Value	Description
yes	When the user changes his password, update SambaNTPassword, SambaLMPassword and the password fields.
no	Only update SambaNTPassword and SambaLMPassword.
only	Only update the LDAP password and let the LDAP server worry about the other fields. This option is only available on some LDAP servers. Only when the LDAP server supports LDAP_EXOP_X_MODIFY_PASSWD.

Table 10.4. Basic smb.conf options for MySQL passdb backend

Field	Contents
mysql host	Host name, defaults to 'localhost'
mysql password	
mysql user	Defaults to 'samba'
mysql database	Defaults to 'samba'
mysql port	Defaults to 3306
table	Name of the table containing the users

Table 10.5. MySQL field names for MySQL passwd backend

Field	Type	Contents
logon time column	int(9)	UNIX time stamp of last logon of user
logoff time column	int(9)	UNIX time stamp of last logoff of user
kickoff time column	int(9)	UNIX time stamp of moment user should be kicked off workstation (not enforced)
pass last set time column	int(9)	UNIX time stamp of moment password was last set
pass can change time column	int(9)	UNIX time stamp of moment from which password can be changed
pass must change time column	int(9)	UNIX time stamp of moment on which password must be changed
username column	varchar(255)	UNIX username
domain column	varchar(255)	NT domain user belongs to
nt username column	varchar(255)	NT username
fullname column	varchar(255)	Full name of user
home dir column	varchar(255)	UNIX homedir path (equivalent of the logon home parameter.
dir drive column	varchar(2)	Directory drive path (e.g., "H:")
logon script column	varchar(255)	Batch file to run on client side when logging on
profile path column	varchar(255)	Path of profile
acct desc column	varchar(255)	Some ASCII NT user data
workstations column	varchar(255)	Workstations user can logon to (or NULL for all)
unknown string column	varchar(255)	Unknown string
munged dial column	varchar(255)	Unknown
user sid column	varchar(255)	NT user SID
group sid column	varchar(255)	NT group SID
lanman pass column	varchar(255)	Encrypted lanman password
nt pass column	varchar(255)	Encrypted nt passwd
plain pass column	varchar(255)	Plaintext password
acct ctrl column	int(9)	NT user data
unknown 3 column	int(9)	Unknown
logon divs column	int(9)	Unknown
hours len column	int(9)	Unknown
bad password count column	int(5)	Number of failed password tries before disabling an account
logon count column	int(5)	Number of logon attempts
unknown 6 column	int(9)	Unknown

GROUP MAPPING — MS WINDOWS AND UNIX

Starting with Samba-3, new group mapping functionality is available to create associations between Windows group SIDs and UNIX groups. The **groupmap** subcommand included with the `net` tool can be used to manage these associations.

The new facility for mapping NT Groups to UNIX system groups allows the administrator to decide which NT Domain Groups are to be exposed to MS Windows clients. Only those NT Groups that map to a UNIX group that has a value other than the default (-1) will be exposed in group selection lists in tools that access domain users and groups.

WARNING

The *domain admin group* parameter has been removed in Samba-3 and should no longer be specified in `smb.conf`. In Samba-2.2.x, this parameter was used to give the listed users membership in the Domain Admins Windows group which gave local admin rights on their workstations (in default configurations).

11.1 Features and Benefits

Samba allows the administrator to create MS Windows NT4/200x group accounts and to arbitrarily associate them with UNIX/Linux group accounts.

Group accounts can be managed using the MS Windows NT4 or MS Windows 200x/XP Professional MMC tools. Appropriate interface scripts should be provided in `smb.conf` if it is desired that UNIX/Linux system accounts should be automatically created when these tools are used. In the absence of these scripts, and so long as **winbindd** is running, Samba group accounts that are created using these tools will be allocated UNIX UIDs/GIDs from the ID range specified by the `idmap uid/idmap gid` parameters in the `smb.conf` file.

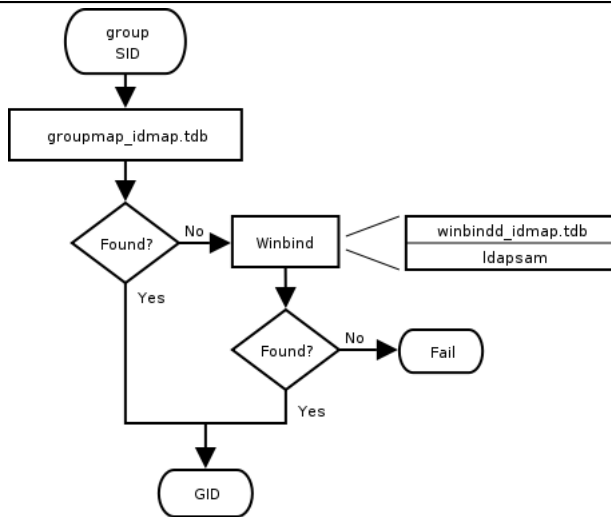

Figure 11.1.

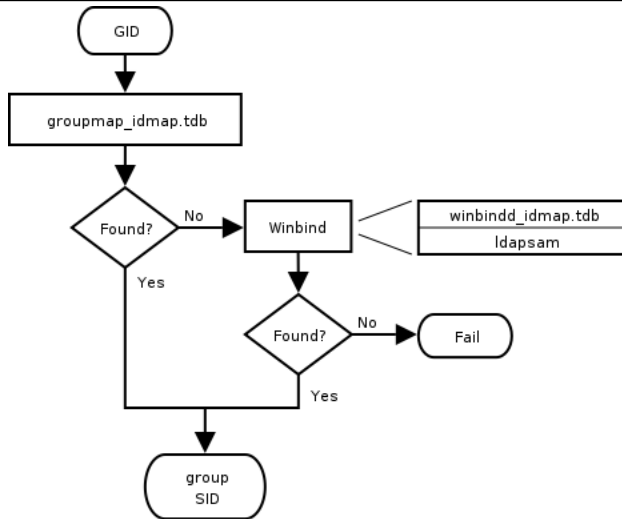

Figure 11.2.

In both cases, when winbindd is not running, only locally resolvable groups can be recognized. Please refer to IDMAP: group SID to GID resolution and IDMAP: GID resolution to matching SID. The **net groupmap** is used to establish UNIX group to NT SID mappings as shown in IDMAP: storing group mappings.

Administrators should be aware that where `smb.conf` group interface scripts make direct calls to the UNIX/Linux system tools (the shadow utilities, **groupadd**, **groupdel**, and **groupmod**), the resulting UNIX/Linux group names will be subject to any limits imposed by these tools. If the tool does not allow upper case characters or space characters, then the



Figure 11.3.

creation of an MS Windows NT4/200x style group of *Engineering Managers* will attempt to create an identically named UNIX/Linux group, an attempt that will of course fail.

There are several possible work-arounds for the operating system tools limitation. One method is to use a script that generates a name for the UNIX/Linux system group that fits the operating system limits, and that then just passes the UNIX/Linux group ID (GID) back to the calling Samba interface. This will provide a dynamic work-around solution.

Another work-around is to manually create a UNIX/Linux group, then manually create the MS Windows NT4/200x group on the Samba server and then use the **net groupmap** tool to connect the two to each other.

11.2 Discussion

When installing MS Windows NT4/200x on a computer, the installation program creates default users and groups, notably the **Administrators** group, and gives that group privileges necessary privileges to perform essential system tasks, such as the ability to change the date and time or to kill (or close) any process running on the local machine.

The **Administrator** user is a member of the **Administrators** group, and thus inherits **Administrators** group privileges. If a **joe** user is created to be a member of the **Administrators** group, **joe** has exactly the same rights as the user, **Administrator**.

When an MS Windows NT4/200x/XP machine is made a Domain Member, the “*Domain Admins*” group of the PDC is added to the local **Administrators** group of the workstation. Every member of the **Domain Administrators** group inherits the rights of the local **Administrators** group when logging on the workstation.

The following steps describe how to make Samba PDC users members of the **Domain Admins** group?

1. Create a UNIX group (usually in `/etc/group`), let’s call it `domadm`.
2. Add to this group the users that must be “*Administrators*”. For example, if you want `joe`, `john` and `mary` to be administrators, your entry in `/etc/group` will look like this:

```
domadm:x:502:joe,john,mary
```

3. Map this `domadm` group to the “*Domain Admins*” group by running the command:

```
root# net groupmap add ntgroup=Domain Admins unixgroup=domadm
```

The quotes around “*Domain Admins*” are necessary due to the space in the group name. Also make sure to leave no white-space surrounding the equal character (=).

Now `joe`, `john` and `mary` are domain administrators.

It is possible to map any arbitrary UNIX group to any Windows NT4/200x group as well as making any UNIX group a Windows domain group. For example, if you wanted to include a UNIX group (e.g., `acct`) in an ACL on a local file or printer on a Domain Member machine, you would flag that group as a domain group by running the following on the Samba PDC:

```
root# net groupmap add rid=1000 ntgroup="Accounting" unixgroup=acct
```

Be aware that the RID parameter is a unsigned 32-bit integer that should normally start at 1000. However, this RID must not overlap with any RID assigned to a user. Verification for this is done differently depending on the `passdb` backend you are using. Future versions of the tools may perform the verification automatically, but for now the burden is on you.

11.2.1 Important Administrative Information

Administrative rights are necessary in two specific forms:

1. For Samba-3 Domain Controllers and Domain Member Servers/Clients.
2. To manage Domain Member Windows workstations.

Administrative tasks on UNIX/Linux systems, such as adding users or groups, requires `root` level privilege. The addition of a Windows client to a Samba Domain involves the addition of a user account for the Windows client.

Many UNIX administrators continue to request the Samba Team make it possible to add Windows workstations, or to ability to add/delete or modify user accounts, without requiring `root` privileges. Such a request violates every understanding of basic UNIX system security.

There is no safe way to provide access on a UNIX/Linux system without providing `root` level privilege. Provision of `root` privileges can be done either by logging onto the Domain as the user `root`, or by permitting particular users to use a UNIX account that has a `UID=0` in the `/etc/passwd` database. Users of such accounts can use tools like the NT4 Domain User Manager, and the NT4 Domain Server Manager to manage user and group accounts as well as Domain Member server and client accounts. This level of privilege is also needed to manage share level ACLs.

Administrative tasks on a Windows Domain Member workstation, can be done by anyone who is a member of the `Domain Admins` group. This group can be mapped to any convenient UNIX group.

11.2.2 Default Users, Groups and Relative Identifiers

When first installed, Microsoft Windows NT4/200x/XP are pre-configured with certain User, Group, and Alias entities. Each has a well-known Relative Identifier (RID). These must be preserved for continued integrity of operation. Samba must be provisioned with

certain essential Domain Groups that require the appropriate RID value. When Samba-3 is configured to use `tdbsam` the essential Domain Groups are automatically created. It is the LDAP administrators' responsibility to create (provision) the default NT Groups.

Each essential Domain Group must be assigned its respective well-known RID. The default Users, Groups, Aliases, and RIDs are shown in Well-Known User Default RIDs table.

NOTE



When the *passwd* backend uses LDAP (`ldapsam`) it is the administrators' responsibility to create the essential Domain Groups, and to assign each its default RID.

It is permissible to create any Domain Group that may be necessary, just make certain that the essential Domain Groups (well known) have been created and assigned its default RID. Other groups you create may be assigned any arbitrary RID you care to use.

Be sure to map each Domain Group to a UNIX system group. That is the only way to ensure that the group will be available for use as an NT Domain Group.

Table 11.1. Well-Known User Default RIDs

Well-Known Entity	RID	Type	Essential
Domain Administrator	500	User	No
Domain Guest	501	User	No
Domain KRBTGT	502	User	No
Domain Admins	512	Group	Yes
Domain Users	513	Group	Yes
Domain Guests	514	Group	Yes
Domain Computers	515	Group	No
Domain Controllers	516	Group	No
Domain Certificate Admins	517	Group	No
Domain Schema Admins	518	Group	No
Domain Enterprise Admins	519	Group	No
Domain Policy Admins	520	Group	No
Builtin Admins	544	Alias	No
Builtin users	545	Alias	No
Builtin Guests	546	Alias	No
Builtin Power Users	547	Alias	No
Builtin Account Operators	548	Alias	No
Builtin System Operators	549	Alias	No
Builtin Print Operators	550	Alias	No
Builtin Backup Operators	551	Alias	No
Builtin Replicator	552	Alias	No
Builtin RAS Servers	553	Alias	No

11.2.3 Example Configuration

You can list the various groups in the mapping database by executing `net groupmap list`. Here is an example:

```
root# net groupmap list
Domain Admins (S-1-5-21-2547222302-1596225915-2414751004-512) -> domadmin
Domain Users (S-1-5-21-2547222302-1596225915-2414751004-513) -> domuser
Domain Guests (S-1-5-21-2547222302-1596225915-2414751004-514) -> domguest
```

For complete details on `net groupmap`, refer to the `net(8)` man page.

11.3 Configuration Scripts

Everyone needs tools. Some of us like to create our own, others prefer to use canned tools (i.e., prepared by someone else for general use).

11.3.1 Sample `smb.conf` Add Group Script

A script to create complying group names for use by the Samba group interfaces is provided in `smbgrpadd.sh`. This script will add a temporary entry in the `/etc/group` file and then rename it to to the desired name. This is an example of a method to get around operating system maintenance tool limitations such as that present in some version of the `groupadd` tool.

Example 11.3.1. `smbgrpadd.sh`

```
#!/bin/bash

# Add the group using normal system groupadd tool.
groupadd smbtmpgrp00

thegid='cat /etc/group | grep ^smbtmpgrp00 | cut -d ":" -f3'

# Now change the name to what we want for the MS Windows networking end
cp /etc/group /etc/group.bak
cat /etc/group.bak | sed "s/^smbtmpgrp00/$1/g" > /etc/group

# Now return the GID as would normally happen.
echo $thegid
exit 0
```

The `smb.conf` entry for the above script would be something like that in the following example.

Example 11.3.2. Configuration of `smb.conf` for the add group script.

```
[global]
...
    add group script = /path_to_tool/smbgrpadd.sh "%g"
...
```

11.3.2 Script to Configure Group Mapping

In our example we have created a UNIX/Linux group called `ntadmin`. Our script will create the additional groups `Orks`, `Elves`, and `Gnomes`. It is a good idea to save this shell script for later re-use just in case you ever need to rebuild your mapping database. For the sake of convenience we elect to save this script as a file called `initGroups.sh`. This script is given in `intGroups.sh`.

Example 11.3.3. Script to Set Group Mapping

```
#!/bin/bash

net groupmap modify ntgroup="Domain Admins" unixgroup=ntadmin
net groupmap modify ntgroup="Domain Users" unixgroup=users
net groupmap modify ntgroup="Domain Guests" unixgroup=nobody

groupadd Orks
groupadd Elves
groupadd Gnomes

net groupmap add ntgroup="Orks"    unixgroup=Orks    type=d
net groupmap add ntgroup="Elves"   unixgroup=Elves   type=d
net groupmap add ntgroup="Gnomes"  unixgroup=Gnomes type=d
```

Of course it is expected that the administrator will modify this to suit local needs. For information regarding the use of the `net groupmap` tool please refer to the man page.

11.4 Common Errors

At this time there are many little surprises for the unwary administrator. In a real sense it is imperative that every step of automated control scripts must be carefully tested manually before putting them into active service.

11.4.1 Adding Groups Fails

This is a common problem when the **groupadd** is called directly by the Samba interface script for the add group script in the **smb.conf** file.

The most common cause of failure is an attempt to add an MS Windows group account that has either an upper case character and/or a space character in it.

There are three possible work-arounds. First, use only group names that comply with the limitations of the UNIX/Linux **groupadd** system tool. Second, it involves the use of the script mentioned earlier in this chapter, and third is the option is to manually create a UNIX/Linux group account that can substitute for the MS Windows group name, then use the procedure listed above to map that group to the MS Windows group.

11.4.2 Adding MS Windows Groups to MS Windows Groups Fails

Samba-3 does not support nested groups from the MS Windows control environment.

11.4.3 Adding *Domain Users* to the *Power Users* Group

“*What must I do to add Domain Users to the Power Users group?*” The Power Users group is a group that is local to each Windows 200x/XP Professional workstation. You cannot add the Domain Users group to the Power Users group automatically, it must be done on each workstation by logging in as the local workstation *administrator* and then using the following procedure:

1. Click **Start** -> **Control Panel** -> **Users and Passwords**.
2. Click the **Advanced** tab.
3. Click the **Advanced** button.
4. Click **Groups**.
5. Double click **Power Users**. This will launch the panel to add users or groups to the local machine **Power Uses** group.
6. Click the **Add** button.
7. Select the domain from which the **Domain Users** group is to be added.
8. Double click the **Domain Users** group.
9. Click the **Ok** button. If a logon box is presented during this process please remember to enter the connect as **DOMAIN\UserName**. i.e., For the domain **MIDEARTH** and the user **root** enter **MIDEARTH\root**.

IDENTITY MAPPING (IDMAP)

The Microsoft Windows operating system has a number of features that impose specific challenges to interoperability with operating system on which Samba is implemented. This chapter deals explicitly with the mechanisms Samba-3 (version 3.0.8 and later) uses to overcome one of the key challenges in the integration of Samba servers into an MS Windows networking environment. This chapter deals with Identify Mapping (IDMAP) of Windows Security Identifiers (SIDs) to UNIX UIDs and GIDs.

To ensure good sufficient coverage each possible Samba deployment type will be discussed. This is followed by an overview of how the IDMAP facility may be implemented.

The IDMAP facility is usually of concern where more than one Samba server (or Samba network client) is installed in the one Domain. Where there is a single Samba server do not be too concerned regarding the IDMAP infrastructure - the default behavior of Samba is nearly always sufficient.

The use of IDMAP is important where the Samba server will be accessed by workstations or servers from more than one domain, in which case it is important to run winbind so it can handle the resolution (ID mapping) of foreign SIDs to local UNIX UIDs and GIDs.

The use of the IDMAP facility requires that the **winbindd** be executed on Samba start-up.

12.1 Samba Server Deployment Types and IDMAP

There are four (4) basic server deployment types, as documented in the chapter on Server Types and Security Modes.

12.1.1 Stand-Alone Samba Server

A stand-alone Samba server is an implementation that is not a member of a Windows NT4 Domain, a Windows 200X Active Directory Domain, or of a Samba Domain.

By definition, this means that users and groups will be created and controlled locally and the identity of a network user must match a local UNIX/Linux user login. The IDMAP facility is therefore of little to no interest, winbind will not be necessary, and the IDMAP facility will not be relevant or of interest.

12.1.2 Domain Member Server or Domain Member Client

Samba-3 can act as a Windows NT4 PDC or BDC thereby providing domain control protocols that are compatible with Windows NT4. Samba-3 file and print sharing protocols are compatible with all version of Microsoft Windows products. Windows NT4, as with Microsoft Active Directory, extensively makes use of Windows security identifiers (SIDs).

Samba-3 Domain Member servers and clients must interact correctly with MS Windows SIDs. Incoming Windows SIDs must be translated to local UNIX UIDs and GIDs. Outgoing information from the Samba server must provide to MS Windows clients and servers appropriate SIDs.

A Samba member of a Windows networking domain (NT4-style or ADS) can be configured to handle identity mapping in a variety of ways. The mechanism it will use depends on whether or not the **winbindd** daemon is used, and how the winbind functionality is configured. The configuration options are briefly described here:

Winbind is not used, users and groups are local: — Where **winbindd** is not used Samba (**smbd**) uses the underlying UNIX/Linux mechanisms to resolve the identity of incoming network traffic. This will be done using the LoginID (account name) in the session setup request and passing it to the `getpwnam()` system function call. This call is implemented using the name service switch (NSS) mechanism on modern UNIX/Linux systems. By saying “*users and groups are local*” we are implying that they are stored only on the local system, in the `/etc/passwd` and `/etc/group` respectively.

For example, if an incoming `SessionSetupAndX` request is owned by the user `BERYLIUM\WambatW`, a system call will be made to look up the user `WambatW` in the `/etc/passwd` file.

This configuration may be used with stand-alone Samba servers, Domain Member servers (NT4 or ADS), and may be used for a PDC that uses either an `smbpasswd` or a `tdbsam` based Samba `passdb` backend.

Winbind is not used, users and groups resolved via NSS: — In this situation user and group accounts are treated as if they are local accounts, the only way in which this differs from having local accounts is that the accounts are stored in a repository that can be shared. In practice this means that they will reside in either a NIS type database or else in LDAP.

This configuration may be used with stand-alone Samba servers, Domain Member servers (NT4 or ADS), and may be used for a PDC that uses either an `smbpasswd` or a `tdbsam` based Samba `passdb` backend.

Winbind/NSS with the default local IDMAP table: — There are many sites that require only a simple Samba server, or a single Samba server that is a member of a Windows NT4 Domain or an ADS Domain. A typical example is an appliance like file server on which no local accounts are configured and winbind is used to obtain account credentials from the domain controllers for the domain. The domain control can be provided by Samba-3, MS Windows NT4 or MS Windows Active Directory.

Winbind is a great convenience in this situation. All that is needed is a range of UID numbers and GID numbers that can be defined in the `smb.conf` file, the `/etc/nsswitch.conf` file is configured to use **winbind** which does all the difficult work of mapping incoming SIDs to appropriate UIDs and GIDs. The SIDs are allocated a UID/GID in the order in which winbind receives them.

This configuration is not convenient or practical in sites that have more than one Samba server and that require the same UID or GID for the same user or group across all servers. One of the hazards of this method is that in the event that the winbind IDMAP file may become corrupted or lost, the repaired or rebuilt IDMAP file may allocate UIDs and GIDs to differing users and groups from what was there previously with the result that MS Windows files that are stored on the Samba server may now not belong to to rightful owner.

Winbind/NSS uses RID based IDMAP: — The IDMAP_RID facility is new to Samba version 3.0.8. It was added to make life easier for a number of sites that are committed to use of MS ADS, who do not want to apply an ADS schema extension, and who do not wish to install an LDAP directory server just for the purpose of maintaining an IDMAP table. If you have a single ADS domain (not a forest of domains, and not multiple domain trees) and you want a simple cookie-cutter solution to the IDMAP table problem, then IDMAP_RID is an obvious choice.

This facility requires the allocation of the *idmap uid* and the *idmap gid* ranges, and within the *idmap uid* it is possible to allocate a sub-set of this range for automatic mapping of the relative identifier (RID) portion of the SID directly to the base of the UID plus the RID value. For example, if the *idmap uid* range is 1000-100000000 and the *idmap backend = idmap_rid:DOMAIN_NAME=1000-50000000*, and a SID is encountered that has the value S-1-5-21-34567898-12529001-32973135-1234, the resulting UID will be 1000 + 1234 = 2234.

Winbind with an NSS/LDAP backend based IDMAP facility: — In this configuration **winbind** resolved SIDs to UIDs and GIDs from the *idmap uid* and *idmap gid* ranges specified in the `smb.conf` file, but instead of using a local winbind IDMAP table it is stored in an LDAP directory so that all Domain Member machines (clients and servers) can share a common IDMAP table.

It is important that all LDAP IDMAP clients use only the master LDAP server as the *idmap backend* facility in the `smb.conf` file does not correctly handle LDAP redirects.

Winbind with NSS to resolve UNIX/Linux user and group IDs: — When Samba is being used as the PDC and BDC the of an LDAP passdb backend is a smart solution, certainly for the domain controllers, but also for Domain Member servers. It is a neat method for assuring that UIDs, GIDs and the matching SIDs will be consistent across all servers.

The use of the LDAP based passdb backend requires use of the PADL `nss_ldap` utility, or an equivalent. In this situation winbind is used to handle foreign SIDs; ie: SIDs from stand-alone Windows clients (i.e.: not a member of our domain) as well as SIDs

IDMAP information can however be written directly to the LDAP server so long as all domain controllers have access to the master (writable) LDAP server. Samba-3 at this time does not handle LDAP redirects in the IDMAP backend. This means that it is unsafe to use a slave (replicate) LDAP server with the IDMAP facility.

12.2 Examples of IDMAP Backend Usage

Anyone who wishes to use **winbind** will find the following example configurations helpful. Remember that in the majority of cases **winbind** is of primary interest for use with Domain Member Servers (DMSs) and Domain Member Clients (DMCs).

12.2.1 Default Winbind TDB

Two common configurations are used:

- Networks that have an NT4 PDC (with or without BDCs) or a Samba PDC (with or without BDCs).
- Networks that use MS Windows 200X ADS.

12.2.1.1 NT4 Style Domains (includes Samba Domains)

The following is a simple example of an NT4 DMS `smb.conf` file that shows only the global section.

```
#Global parameters
[global]
    workgroup = MEGANET2
    security = DOMAIN
    idmap uid = 10000-20000
    idmap gid = 10000-20000
    template primary group = "Domain Users"
    template shell = /bin/bash
```

The use of **winbind** requires configuration of NSS. Edit the `/etc/nsswitch.conf` so it includes the following entries:

```
...
passwd: files winbind
shadow: files winbind
group: files winbind
...
hosts: files wins
...
```

The creation of the DMS requires the following steps:

1. Create or install and `smb.conf` file with the above configuration.
2. Execute:

```
root# net rpc join -UAdministrator%password
Joined domain MEGANET2.
```

The success or failure of the join can be confirmed with the following command:

```
root# net rpc testjoin
Join to 'MIDEARTH' is OK
```

A failed join would report an error message like the following:

```
root# net rpc testjoin
[2004/11/05 16:34:12, 0] utils/net_rpc_join.c:net_rpc_join_ok(66)
Join to domain 'MEGANET2' is not valid
```

3. Start the `nmbd`, `winbind`, and `smbd` daemons in the order shown.

12.2.1.2 ADS Domains

The procedure for joining and ADS domain is similar to the NT4 domain join, except the `smb.conf` file will have the following contents:

```
# Global parameters
[global]
    workgroup = BUTTERNET
    netbios name = GARGOYLE
    realm = BUTTERNET.BIZ
    security = ADS
    template shell = /bin/bash
    idmap uid = 500-10000000
    idmap gid = 500-10000000
    winbind use default domain = Yes
    winbind nested groups = Yes
    printer admin = "BUTTERNET\Domain Admins"
```

ADS DMS operation requires use of kerberos (KRB). For this to work the `krb5.conf` must be configured. The exact requirements depends on which version of MIT or Heimdal kerberos is being used. It is sound advice to use only the latest version, which at this time are MIT kerberos version 1.3.5 and Heimdal 0.61.

The creation of the DMS requires the following steps:

1. Create or install and `smb.conf` file with the above configuration.
2. Edit the `/etc/nsswitch.conf` file as shown above.
3. Execute:

```
root# net ads join -UAdministrator%password
Joined domain BUTTERNET.
```

The success or failure of the join can be confirmed with the following command:

```
root# net ads testjoin
Using short domain name -- BUTTERNET
Joined 'GARGOYLE' to realm 'BUTTERNET.BIZ'
```

An invalid or failed join can be detected by executing:

```
root# net ads testjoin
GARGOYLE$@'s password:
[2004/11/05 16:53:03, 0] utils/net_ads.c:ads_startup(186)
  ads_connect: No results returned
Join to domain is not valid
```

The specific error message may differ from the above as it depends on the type of failure that may have occurred. Increase the *log level* to 10, repeat the above test and then examine the log files produced to identify the nature of the failure.

4. Start the `nmbd`, `winbind`, and `smbd` daemons in the order shown.

12.2.2 IDMAP_RID with Winbind

The `idmap_rid` facility is a new tool that, unlike native winbind, creates a predictable mapping of MS Windows SIDs to UNIX UIDs and GIDs. The key benefit of this method of implementing the Samba IDMAP facility is that it eliminates the need to store the IDMAP data in a central place. The down-side is that it can be used only within a single ADS Domain and is not compatible with trusted domain implementations.

This alternate method of SID to UID/GID mapping can be achieved uses the `idmap_rid` plug-in. This plug-in uses the RID of the user SID to derive the UID and GID by adding the RID to a base value specified. This utility requires that the parameter “*allow trusted domains = No*” must be specified, as it is not compatible with multiple domain environments. The *idmap uid* and *idmap gid* ranges must be specified.

The `idmap_rid` facility can be used both for NT4/Samba style domains as well as with Active Directory. To use this with an NT4 Domain the *realm* is not used, additionally the method used to join the domain uses the `net rpc join` process.

An example `smb.conf` file for an ADS domain environment is shown here:

```
# Global parameters
[global]
    workgroup = KPAK
    netbios name = BIGJOE
    realm = CORP.KPAK.COM
    server string = Office Server
    security = ADS
    allow trusted domains = No
    idmap backend = idmap_rid:KPAK=500-100000000
    idmap uid = 500-100000000
    idmap gid = 500-100000000
    template shell = /bin/bash
    winbind use default domain = Yes
    winbind enum users = No
    winbind enum groups = No
    winbind nested groups = Yes
    printer admin = "Domain Admins"
```

In a large domain with many users it is imperative to disable enumeration of users and groups. For example, at a site that has 22,000 users in Active Directory the winbind based user and group resolution is unavailable for nearly 12 minutes following first start-up of **winbind**. Disabling of such enumeration resulted in instantaneous response. The disabling of user and group enumeration means that it will not be possible to list users or groups using the **getent passwd** and **getent group** commands. It will be possible to perform the lookup for individual users, as shown in the procedure below.

The use of this tool requires configuration of NSS as per the native use of winbind. Edit the `/etc/nsswitch.conf` so it has the following parameters:

```
...
passwd: files winbind
shadow: files winbind
group: files winbind
...
hosts: files wins
...
```

The following procedure can be used to utilize the `idmap_rid` facility:

1. Create or install an `smb.conf` file with the above configuration.
2. Edit the `/etc/nsswitch.conf` file as shown above.
3. Execute:

```
root# net ads join -Uadministrator%password
Using short domain name -- KPAK
Joined 'BIGJOE' to realm 'CORP.KPAK.COM'
```

An invalid or failed join can be detected by executing:

```
root# net ads testjoin
BIGJOE$@'s password:
[2004/11/05 16:53:03, 0] utils/net_ads.c:ads_startup(186)
  ads_connect: No results returned
Join to domain is not valid
```

The specific error message may differ from the above as it depends on the type of failure that may have occurred. Increase the *log level* to 10, repeat the above test and then examine the log files produced to identify the nature of the failure.

4. Start the **nmbd**, **winbind**, and **smbd** daemons in the order shown.
5. Validate the operation of this configuration by executing:

```
root# getent passwd administrator
administrator:x:1000:1013:Administrator:/home/BE/administrator:/bin/bash
```

12.2.3 IDMAP Storage in LDAP using Winbind

The storage of IDMAP information in LDAP can be used with both NT4/Samba-3 style domains as well as with ADS domains. OpenLDAP is a commonly used LDAP server for this purpose, although any standards complying LDAP server can be used. It is therefore possible to deploy this IDMAP configuration using the Sun iPlanet LDAP server, Novell eDirectory, Microsoft ADS plus ADAM, and so on.

The following example is for an ADS style domain:

```
# Global parameters
[global]
    workgroup = SNOWSHOW
    netbios name = GOODELF
    realm = SNOWSHOW.COM
    server string = Samba Server
    security = ADS
    log level = 1 ads:10 auth:10 sam:10 rpc:10
    ldap admin dn = cn=Manager,dc=SNOWSHOW,dc=COM
    ldap idmap suffix = ou=Idmap
    ldap suffix = dc=SNOWSHOW,dc=COM
    idmap backend = ldap:ldap://ldap.snowshow.com
```

```
idmap uid = 150000-550000
idmap gid = 150000-550000
template shell = /bin/bash
winbind use default domain = Yes
```

In the case of an NT4 or Samba-3 style Domain the *realm* is not used and the command used to join the domain is: **net rpc join**. The above example also demonstrates advanced error reporting techniques that are documented in the chapter called Reporting Bugs.

Where MIT kerberos is installed (version 1.3.4 or later) edit the `/etc/krb5.conf` file so it has the following contents:

```
[logging]
default = FILE:/var/log/krb5libs.log
kdc = FILE:/var/log/krb5kdc.log
admin_server = FILE:/var/log/kadmind.log

[libdefaults]
default_realm = SNOWSHOW.COM
dns_lookup_realm = false
dns_lookup_kdc = true

[appdefaults]
pam = {
    debug = false
    ticket_lifetime = 36000
    renew_lifetime = 36000
    forwardable = true
    krb4_convert = false
}
```

Where Heimdal kerberos is installed edit the `/etc/krb5.conf` file so it is either empty (i.e.: no contents) or it has the following contents:

```
[libdefaults]
    default_realm = SNOWSHOW.COM
    clocks skew = 300

[realms]
    SNOWSHOW.COM = {
        kdc = ADSDC.SHOWSHOW.COM
    }

[domain_realm]
    .snowshow.com = SNOWSHOW.COM
```

NOTE



Samba can not use the Heimdal libraries if there is no `/etc/krb5.conf` file. So long as there is an empty file the Heimdal kerberos libraries will be usable. There is no need to specify any settings as Samba using the Heimdal libraries can figure this out automatically.

Edit the NSS control file `/etc/nsswitch.conf` so it has the following entries:

```
...
passwd: files ldap
shadow: files ldap
group: files ldap
...
hosts: files wins
...
```

You will need the PADL <<http://www.padl.com>> **nss_ldap** tool set for this solution. Configure the `/etc/ldap.conf` file so it has the information needed. The following is an example of a working file:

```
host      192.168.2.1
base      dc=snowshow,dc=com
binddn    cn=Manager,dc=snowshow,dc=com
bindpw    not24get

pam_password exop

nss_base_passwd ou=People,dc=snowshow,dc=com?one
nss_base_shadow ou=People,dc=snowshow,dc=com?one
nss_base_group  ou=Groups,dc=snowshow,dc=com?one
ssl            no
```

The following procedure may be followed to affect a working configuration:

1. Configure the `smb.conf` file as shown above.
2. Create the `/etc/krb5.conf` file following the indications above.
3. Configure the `/etc/nsswitch.conf` file as shown above.
4. Download, build and install the PADL `nss_ldap` tool set. Configure the `/etc/ldap.conf` file as shown above.

5. Configure an LDAP server, initialize the directory with the top level entries needed by IDMAP as shown in the following LDIF file:

```
dn: dc=snowshow,dc=com
objectClass: dcObject
objectClass: organization
dc: snowshow
o: The Greatest Snow Show in Singapore.
description: Posix and Samba LDAP Identity Database

dn: cn=Manager,dc=snowshow,dc=com
objectClass: organizationalRole
cn: Manager
description: Directory Manager

dn: ou=Idmap,dc=snowshow,dc=com
objectClass: organizationalUnit
ou: idmap
```

6. Execute the command to join the Samba Domain Member Server to the ADS domain as shown here:

```
root# net ads testjoin
Using short domain name -- SNOWSHOW
Joined 'GOODELF' to realm 'SNOWSHOW.COM'
```

7. Start the **nmbd**, **winbind**, and **smbd** daemons in the order shown.

Follow the diagnostic procedures shown earlier in this chapter to identify success or failure of the join. In many cases a failure is indicated by a silent return to the command prompt with no indication of the reason for failure.

12.2.4 IDMAP and NSS Using LDAP From ADS with RFC2307bis Schema Extension

The use of this method is messy. The information provided in the following is for guidance only and is very definitely not complete. This method does work; it is used in a number of large sites and has an acceptable level of performance.

The following is an example `smb.conf` file:

```
# Global parameters
[global]
    workgroup = BOBBY
    realm = BOBBY.COM
    security = ADS
```

```
idmap uid = 150000-550000
idmap gid = 150000-550000
template shell = /bin/bash
winbind cache time = 5
winbind use default domain = Yes
winbind trusted domains only = Yes
winbind nested groups = Yes
```

The DMS must be joined to the domain using the usual procedure. Additionally, it is necessary to build and install the PADL `nss.ldap` tool set. Be sure to build this tool set with the following:

```
./configure --enable-rfc2307bis --enable-schema-mapping
make install
```

The following `/etc/nsswitch.conf` file contents are required:

```
...
passwd: files ldap
shadow: files ldap
group: files ldap
...
hosts: files wins
...
```

The `/etc/ldap.conf` file must be configured also. Refer to the PADL documentation and source code for `nss.ldap` to specific instructions.

The next step involves preparation on the ADS schema. This is briefly discussed in the remaining part of this chapter.

12.2.4.1 IDMAP, Active Directory and MS Services for UNIX 3.5

The Microsoft Windows Service for UNIX (SFU) version 3.5 is available for free download <<http://www.microsoft.com/windows/sfu/>> from the Microsoft Web site. You will need to download this tool and install it following Microsoft instructions.

12.2.4.2 IDMAP, Active Directory and AD4UNIX

Instructions for obtaining and installing the AD4UNIX tool set can be found from the Geekcomix <http://www.geekcomix.com/cgi-bin/classnotes/wiki.pl?LDAP01/An_Alternative_Approach> web site.

FILE, DIRECTORY AND SHARE ACCESS CONTROLS

Advanced MS Windows users are frequently perplexed when file, directory and share manipulation of resources shared via Samba do not behave in the manner they might expect. MS Windows network administrators are often confused regarding network access controls and how to provide users with the access they need while protecting resources from unauthorized access.

Many UNIX administrators are unfamiliar with the MS Windows environment and in particular have difficulty in visualizing what the MS Windows user wishes to achieve in attempts to set file and directory access permissions.

The problem lies in the differences in how file and directory permissions and controls work between the two environments. This difference is one that Samba cannot completely hide, even though it does try to bridge the chasm to a degree.

POSIX Access Control List technology has been available (along with Extended Attributes) for UNIX for many years, yet there is little evidence today of any significant use. This explains to some extent the slow adoption of ACLs into commercial Linux products. MS Windows administrators are astounded at this, given that ACLs were a foundational capability of the now decade-old MS Windows NT operating system.

The purpose of this chapter is to present each of the points of control that are possible with Samba-3 in the hope that this will help the network administrator to find the optimum method for delivering the best environment for MS Windows desktop users.

This is an opportune point to mention that Samba was created to provide a means of interoperability and interchange of data between differing operating environments. Samba has no intent to change UNIX/Linux into a platform like MS Windows. Instead the purpose was and is to provide a sufficient level of exchange of data between the two environments. What is available today extends well beyond early plans and expectations, yet the gap continues to shrink.

13.1 Features and Benefits

Samba offers a lot of flexibility in file system access management. These are the key access control facilities present in Samba today:

SAMBA ACCESS CONTROL FACILITIES

- *UNIX File and Directory Permissions*

Samba honors and implements UNIX file system access controls. Users who access a Samba server will do so as a particular MS Windows user. This information is passed to the Samba server as part of the logon or connection setup process. Samba uses this user identity to validate whether or not the user should be given access to file system resources (files and directories). This chapter provides an overview for those to whom the UNIX permissions and controls are a little strange or unknown.

- *Samba Share Definitions*

In configuring share settings and controls in the `smb.conf` file, the network administrator can exercise overrides to native file system permissions and behaviors. This can be handy and convenient to effect behavior that is more like what MS Windows NT users expect but it is seldom the *best* way to achieve this. The basic options and techniques are described herein.

- *Samba Share ACLs*

Just like it is possible in MS Windows NT to set ACLs on shares themselves, so it is possible to do this in Samba. Few people make use of this facility, yet it remains one of the easiest ways to affect access controls (restrictions) and can often do so with minimum invasiveness compared with other methods.

- *MS Windows ACLs through UNIX POSIX ACLs*

The use of POSIX ACLs on UNIX/Linux is possible only if the underlying operating system supports them. If not, then this option will not be available to you. Current UNIX technology platforms have native support for POSIX ACLs. There are patches for the Linux kernel that also provide this. Sadly, few Linux platforms ship today with native ACLs and Extended Attributes enabled. This chapter has pertinent information for users of platforms that support them.

13.2 File System Access Controls

Perhaps the most important recognition to be made is the simple fact that MS Windows NT4/200x/XP implement a totally divergent file system technology from what is provided in the UNIX operating system environment. First we consider what the most significant differences are, then we look at how Samba helps to bridge the differences.

13.2.1 MS Windows NTFS Comparison with UNIX File Systems

Samba operates on top of the UNIX file system. This means it is subject to UNIX file system conventions and permissions. It also means that if the MS Windows networking

environment requires file system behavior that differs from UNIX file system behavior then somehow Samba is responsible for emulating that in a transparent and consistent manner.

It is good news that Samba does this to a large extent and on top of that provides a high degree of optional configuration to override the default behavior. We look at some of these over-rides, but for the greater part we will stay within the bounds of default behavior. Those wishing to explore the depths of control ability should review the `smb.conf` man page.

The following compares file system features for UNIX with those of Microsoft Windows NT/200x:

Name Space MS Windows NT4/200x/XP files names may be up to 254 characters long, and UNIX file names may be 1023 characters long. In MS Windows, file extensions indicate particular file types, in UNIX this is not so rigorously observed as all names are considered arbitrary.

What MS Windows calls a folder, UNIX calls a directory.

Case Sensitivity MS Windows file names are generally upper case if made up of 8.3 (8 character file name and 3 character extension. File names that are longer than 8.3 are case preserving and case insensitive.

UNIX file and directory names are case sensitive and case preserving. Samba implements the MS Windows file name behavior, but it does so as a user application. The UNIX file system provides no mechanism to perform case insensitive file name lookups. MS Windows does this by default. This means that Samba has to carry the processing overhead to provide features that are not native to the UNIX operating system environment.

Consider the following. All are unique UNIX names but one single MS Windows file name:

```
MYFILE.TXT
MyFile.txt
myfile.txt
```

So clearly, in an MS Windows file name space these three files cannot co-exist, but in UNIX they can.

So what should Samba do if all three are present? That which is lexically first will be accessible to MS Windows users, the others are invisible and unaccessible — any other solution would be suicidal.

Directory Separators MS Windows and DOS uses the backslash `\` as a directory delimiter, and UNIX uses the forward-slash `/` as its directory delimiter. This is handled transparently by Samba.

Drive Identification MS Windows products support a notion of drive letters, like **C:** to represent disk partitions. UNIX has no concept of separate identifiers for file partitions, each such file system is mounted to become part of the overall directory tree. The UNIX directory tree begins at / just like the root of a DOS drive is specified as **C:**.

File Naming Conventions MS Windows generally never experiences file names that begin with a dot (.) while in UNIX these are commonly found in a user's home directory. Files that begin with a dot (.) are typically either start-up files for various UNIX applications, or they may be files that contain start-up configuration data.

Links and Short-Cuts MS Windows make use of "*links and short-cuts*" that are actually special types of files that will redirect an attempt to execute the file to the real location of the file. UNIX knows of file and directory links, but they are entirely different from what MS Windows users are used to.

Symbolic links are files in UNIX that contain the actual location of the data (file or directory). An operation (like read or write) will operate directly on the file referenced. Symbolic links are also referred to as "*soft links*." A hard link is something that MS Windows is not familiar with. It allows one physical file to be known simultaneously by more than one file name.

There are many other subtle differences that may cause the MS Windows administrator some temporary discomfort in the process of becoming familiar with UNIX/Linux. These are best left for a text that is dedicated to the purpose of UNIX/Linux training and education.

13.2.2 Managing Directories

There are three basic operations for managing directories: **create**, **delete**, **rename**.

Table 13.1. Managing Directories with UNIX and Windows

Action	MS Windows Command	UNIX Command
create	md folder	mkdir folder
delete	rd folder	rmdir folder
rename	rename oldname newname	mv oldname newname

13.2.3 File and Directory Access Control

The network administrator is strongly advised to read foundational training manuals and reference materials regarding file and directory permissions maintenance. Much can be achieved with the basic UNIX permissions without having to resort to more complex facilities like POSIX Access Control Lists (ACLs) or Extended Attributes (EAs).

UNIX/Linux file and directory access permissions involves setting three primary sets of data and one control set. A UNIX file listing looks as follows:

```

$ ls -la
total 632
drwxr-xr-x  13 maryo  gnomes      816 2003-05-12 22:56 .
drwxrwxr-x  37 maryo  gnomes     3800 2003-05-12 22:29 ..
dr-xr-xr-x   2 maryo  gnomes      48 2003-05-12 22:29 mucho02
drwxrwxrwx   2 maryo  gnomes      48 2003-05-12 22:29 mucho03
drw-rw-rw-   2 maryo  gnomes      48 2003-05-12 22:29 mucho04
d-w--w--w-   2 maryo  gnomes      48 2003-05-12 22:29 mucho05
dr--r--r--   2 maryo  gnomes      48 2003-05-12 22:29 mucho06
drwsrwsrwx   2 maryo  gnomes      48 2003-05-12 22:29 mucho08
-----     1 maryo  gnomes     1242 2003-05-12 22:31 mydata00.lst
--w--w--w-   1 maryo  gnomes     7754 2003-05-12 22:33 mydata02.lst
-r--r--r--   1 maryo  gnomes    21017 2003-05-12 22:32 mydata04.lst
-rw-rw-rw-   1 maryo  gnomes    41105 2003-05-12 22:32 mydata06.lst
$

```

The columns above represent (from left to right): permissions, number of hard links to file, owner, group, size (bytes), access date, access time, file name.

An overview of the permissions field can be found in Overview of UNIX permissions field.

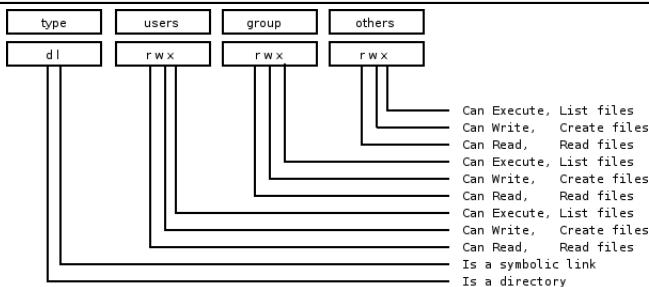

Figure 13.1. Overview of UNIX permissions field.

Any bit flag may be unset. An unset bit flag is the equivalent of “cannot” and is represented as a “-” character.

Example 13.2.1. Example File

```

-rwxr-x--- Means: The owner (user) can read, write, execute
              the group can read and execute
              everyone else cannot do anything with it.

```

Additional possibilities in the [type] field are: c = character device, b = block device, p = pipe device, s = UNIX Domain Socket.

The letters `rwXst` set permissions for the user, group and others as: read (r), write (w), execute (or access for directories) (x), execute only if the file is a directory or already has execute permission for some user (X), set user or group ID on execution (s), sticky (t).

When the sticky bit is set on a directory, files in that directory may be unlinked (deleted) or renamed only by root or their owner. Without the sticky bit, anyone able to write to the directory can delete or rename files. The sticky bit is commonly found on directories, such as `/tmp`, that are world-writable.

When the set user or group ID bit (s) is set on a directory, then all files created within it will be owned by the user and/or group whose ‘set user or group’ bit is set. This can be helpful in setting up directories for which it is desired that all users who are in a group should be able to write to and read from a file, particularly when it is undesirable for that file to be exclusively owned by a user whose primary group is not the group that all such users belong to.

When a directory is set `d-wx--x---` this means that the owner can read and create (write) files in it, but because the (r) read flags are not set, files cannot be listed (seen) in the directory by anyone. The group can read files in the directory but cannot create new files. If files in the directory are set to be readable and writable for the group, then group members will be able to write to (or delete) them.

13.3 Share Definition Access Controls

The following parameters in the `smb.conf` file sections define a share control or effect access controls. Before using any of the following options, please refer to the man page for `smb.conf`.

13.3.1 User and Group-Based Controls

User and group-based controls can prove quite useful. In some situations it is distinctly desirable to affect all file system operations as if a single user were doing so. The use of the `force user` and `force group` behavior will achieve this. In other situations it may be necessary to effect a paranoia level of control to ensure that only particular authorized persons will be able to access a share or its contents. Here the use of the `valid users` or the `invalid users` may be most useful.

As always, it is highly advisable to use the least difficult to maintain and the least ambiguous method for controlling access. Remember, when you leave the scene someone else will need to provide assistance and if he finds too great a mess or does not understand what you have done, there is risk of Samba being removed and an alternative solution being adopted.

Following table enumerates these controls.

13.3.2 File and Directory Permissions-Based Controls

The following file and directory permission-based controls, if misused, can result in considerable difficulty to diagnose causes of misconfiguration. Use them sparingly and carefully. By gradually introducing each one by one, undesirable side effects may be detected. In the

Table 13.2. User and Group Based Controls

Control Parameter	Description - Action - Notes
admin users	List of users who will be granted administrative privileges on the share. They will do all file operations as the super-user (root). Any user in this list will be able to do anything they like on the share, irrespective of file permissions.
force group	Specifies a UNIX group name that will be assigned as the default primary group for all users connecting to this service.
force user	Specifies a UNIX user name that will be assigned as the default user for all users connecting to this service. This is useful for sharing files. Incorrect use can cause security problems.
guest ok	If this parameter is set for a service, then no password is required to connect to the service. Privileges will be those of the guest account.
invalid users	List of users that should not be allowed to login to this service.
only user	Controls whether connections with usernames not in the user list will be allowed.
read list	List of users that are given read-only access to a service. Users in this list will not be given write access, no matter what the read only option is set to.
username	Refer to the <code>smb.conf</code> man page for more information – this is a complex and potentially misused parameter.
valid users	List of users that should be allowed to login to this service.
write list	List of users that are given read-write access to a service.

event of a problem, always comment all of them out and then gradually reintroduce them in a controlled way.

Refer to the following table for information regarding the parameters that may be used to affect file and directory permission-based access controls.

13.3.3 Miscellaneous Controls

The following are documented because of the prevalence of administrators creating inadvertent barriers to file access by not understanding the full implications of `smb.conf` file settings. See following table.

13.4 Access Controls on Shares

This section deals with how to configure Samba per share access control restrictions. By default, Samba sets no restrictions on the share itself. Restrictions on the share itself can be set on MS Windows NT4/200x/XP shares. This can be an effective way to limit who can connect to a share. In the absence of specific restrictions the default setting is to allow the global user `Everyone - Full Control` (full control, change and read).

Table 13.3. File and Directory Permission Based Controls

Control Parameter	Description - Action - Notes
create mask	Refer to the <code>smb.conf</code> man page.
directory mask	The octal modes used when converting DOS modes to UNIX modes when creating UNIX directories. See also: directory security mask.
dos filemode	Enabling this parameter allows a user who has write access to the file to modify the permissions on it.
force create mode	This parameter specifies a set of UNIX mode bit permissions that will always be set on a file created by Samba.
force directory mode	This parameter specifies a set of UNIX mode bit permissions that will always be set on a directory created by Samba.
force directory security mode	Controls UNIX permission bits modified when a Windows NT client is manipulating UNIX permissions on a directory.
force security mode	Controls UNIX permission bits modified when a Windows NT client manipulates UNIX permissions.
hide unreadable	Prevents clients from seeing the existence of files that cannot be read.
hide unwriteable files	Prevents clients from seeing the existence of files that cannot be written to. Unwriteable directories are shown as usual.
nt acl support	This parameter controls whether <code>smbd</code> will attempt to map UNIX permissions into Windows NT access control lists.
security mask	Controls UNIX permission bits modified when a Windows NT client is manipulating the UNIX permissions on a file.

At this time Samba does not provide a tool for configuring access control setting on the share itself. Samba does have the capacity to store and act on access control settings, but the only way to create those settings is to use either the NT4 Server Manager or the Windows 200x MMC for Computer Management.

Samba stores the per share access control settings in a file called `share.info.tdb`. The location of this file on your system will depend on how Samba was compiled. The default location for Samba's tdb files is under `/usr/local/samba/var`. If the `tdbdump` utility has been compiled and installed on your system, then you can examine the contents of this file by executing: `tdbdump share.info.tdb` in the directory containing the tdb files.

13.4.1 Share Permissions Management

The best tool for the task is platform dependant. Choose the best tool for your environment.

Table 13.4. Other Controls

Control Parameter	Description - Action - Notes
case sensitive, default case, short preserve case	This means that all file name lookup will be done in a case sensitive manner. Files will be created with the precise file name Samba received from the MS Windows client.
csc policy	Client Side Caching Policy - parallels MS Windows client side file caching capabilities.
dont descend	Allows specifying a comma-delimited list of directories that the server should always show as empty.
dos filetime resolution	This option is mainly used as a compatibility option for Visual C++ when used against Samba shares.
dos filetimes	DOS and Windows allow users to change file time stamps if they can write to the file. POSIX semantics prevent this. This option allows DOS and Windows behavior.
fake oplocks	Oplocks are the way that SMB clients get permission from a server to locally cache file operations. If a server grants an oplock, the client is free to assume that it is the only one accessing the file and it will aggressively cache file data.
hide dot files, hide files, veto files	Note: MS Windows Explorer allows override of files marked as hidden so they will still be visible.
read only	If this parameter is yes, then users of a service may not create or modify files in the service's directory.
veto files	List of files and directories that are neither visible nor accessible.

13.4.1.1 Windows NT4 Workstation/Server

The tool you need to use to manage share permissions on a Samba server is the NT Server Manager. Server Manager is shipped with Windows NT4 Server products but not with Windows NT4 Workstation. You can obtain the NT Server Manager for MS Windows NT4 Workstation from Microsoft — see details below.

Instructions

1. Launch the NT4 Server Manager, click on the Samba server you want to administer. From the menu select **Computer**, then click on **Shared Directories**.
2. Click on the share that you wish to manage, then click the **Properties** tab. then click the **Permissions** tab. Now you can add or change access control settings as you wish.

13.4.1.2 Windows 200x/XP

On MS Windows NT4/200x/XP system access control lists on the share itself are set using native tools, usually from File Manager. For example, in Windows 200x, right click on the shared folder, then select **Sharing**, then click on **Permissions**. The default Windows NT4/200x permission allows “*Everyone*” full control on the share.

MS Windows 200x and later versions come with a tool called the Computer Management snap-in for the Microsoft Management Console (MMC). This tool is located by clicking on **Control Panel -> Administrative Tools -> Computer Management**. Instructions

1. After launching the MMC with the Computer Management snap-in, click the menu item **Action**, and select **Connect to another computer**. If you are not logged onto a domain you will be prompted to enter a domain login user identifier and a password. This will authenticate you to the domain. If you are already logged in with administrative privilege, this step is not offered.
2. If the Samba server is not shown in the **Select Computer** box, type in the name of the target Samba server in the field **Name:**. Now click the on **[+]** next to **System Tools**, then on the **[+]** next to **Shared Folders** in the left panel.
3. In the right panel, double-click on the share on which you wish to set access control permissions. Then click the tab **Share Permissions**. It is now possible to add access control entities to the shared folder. Remember to set what type of access (full control, change, read) you wish to assign for each entry.

WARNING

Be careful. If you take away all permissions from the Everyone user without removing this user, effectively no user will be able to access the share. This is a result of what is known as ACL precedence. Everyone with *no access* means that MaryK who is part of the group Everyone will have no access even if she is given explicit full control access.

13.5 MS Windows Access Control Lists and UNIX Interoperability

13.5.1 Managing UNIX Permissions Using NT Security Dialogs

Windows NT clients can use their native security settings dialog box to view and modify the underlying UNIX permissions.

This ability is careful not to compromise the security of the UNIX host on which Samba is running, and still obeys all the file permission rules that a Samba administrator can set.

Samba does not attempt to go beyond POSIX ACLs, so the various finer-grained access control options provided in Windows are actually ignored.

NOTE



All access to UNIX/Linux system files via Samba is controlled by the operating system file access controls. When trying to figure out file access problems, it is vitally important to find the identity of the Windows user as it is presented by Samba at the point of file access. This can best be determined from the Samba log files.

13.5.2 Viewing File Security on a Samba Share

From an NT4/2000/XP client, right click on any file or directory in a Samba-mounted drive letter or UNC path. When the menu pops up, click on the **Properties** entry at the bottom of the menu. This brings up the file **Properties** dialog box. Click on the **Security** tab and you will see three buttons: **Permissions**, **Auditing**, and **Ownership**. The **Auditing** button will cause either an error message ‘A requested privilege is not held by the client’ to appear if the user is not the NT Administrator, or a dialog which is intended to allow an Administrator to add auditing requirements to a file if the user is logged on as the NT Administrator. This dialog is non-functional with a Samba share at this time, as the only useful button, the **Add** button, will not currently allow a list of users to be seen.

13.5.3 Viewing File Ownership

Clicking on the **Ownership** button brings up a dialog box telling you who owns the given file. The owner name will be displayed like this:

“*SERVER\user (Long name)*”

SERVER is the NetBIOS name of the Samba server, *user* is the user name of the UNIX user who owns the file, and (*Long name*) is the descriptive string identifying the user (normally found in the GECOS field of the UNIX password database). Click on the **Close** button to remove this dialog.

If the parameter `nt acl support` is set to `false`, the file owner will be shown as the NT user *Everyone*.

The **Take Ownership** button will not allow you to change the ownership of this file to yourself (clicking it will display a dialog box complaining that the user you are currently logged onto the NT client cannot be found). The reason for this is that changing the ownership of a file is a privileged operation in UNIX, available only to the *root* user. As clicking on this button causes NT to attempt to change the ownership of a file to the current user logged into the NT client, this will not work with Samba at this time.

There is an NT **chown** command that will work with Samba and allow a user with Administrator privilege connected to a Samba server as root to change the ownership of files on both a local NTFS filesystem or remote mounted NTFS or Samba drive. This is available as part of the Seclib NT security library written by Jeremy Allison of the Samba Team, and is available from the main Samba FTP site.

13.5.4 Viewing File or Directory Permissions

The third button is the **Permissions** button. Clicking on this brings up a dialog box that shows both the permissions and the UNIX owner of the file or directory. The owner is displayed like this:

```
SERVER\user (Long name)
```

Where *SERVER* is the NetBIOS name of the Samba server, *user* is the user name of the UNIX user who owns the file, and (*Long name*) is the descriptive string identifying the user (normally found in the GECOS field of the UNIX password database).

If the parameter `nt acl support` is set to `false`, the file owner will be shown as the NT user *Everyone* and the permissions will be shown as NT “*Full Control*”.

The permissions field is displayed differently for files and directories, so I’ll describe the way file permissions are displayed first.

13.5.4.1 File Permissions

The standard UNIX user/group/world triplet and the corresponding **read**, **write**, **execute** permissions triplets are mapped by Samba into a three element NT ACL with the “*r*”, “*w*” and “*x*” bits mapped into the corresponding NT permissions. The UNIX world permissions are mapped into the global NT group *Everyone*, followed by the list of permissions allowed for UNIX world. The UNIX owner and group permissions are displayed as an NT **user** icon and an NT **local group** icon, respectively, followed by the list of permissions allowed for the UNIX user and group.

Because many UNIX permission sets do not map into common NT names such as **read**, **change** or **full control**, usually the permissions will be prefixed by the words **Special Access** in the NT display list.

But what happens if the file has no permissions allowed for a particular UNIX user group or world component? In order to allow “*no permissions*” to be seen and modified Samba then overloads the NT **Take Ownership** ACL attribute (which has no meaning in UNIX) and

reports a component with no permissions as having the NT **O** bit set. This was chosen, of course, to make it look like a zero, meaning zero permissions. More details on the decision behind this is given below.

13.5.4.2 Directory Permissions

Directories on an NT NTFS file system have two different sets of permissions. The first set is the ACL set on the directory itself, which is usually displayed in the first set of parentheses in the normal RW NT style. This first set of permissions is created by Samba in exactly the same way as normal file permissions are, described above, and is displayed in the same way.

The second set of directory permissions has no real meaning in the UNIX permissions world and represents the *inherited* permissions that any file created within this directory would inherit.

Samba synthesizes these inherited permissions for NT by returning as an NT ACL the UNIX permission mode that a new file created by Samba on this share would receive.

13.5.5 Modifying File or Directory Permissions

Modifying file and directory permissions is as simple as changing the displayed permissions in the dialog box, and clicking on **OK**. However, there are limitations that a user needs to be aware of, and also interactions with the standard Samba permission masks and mapping of DOS attributes that need to also be taken into account.

If the parameter `nt acl support` is set to `false`, any attempt to set security permissions will fail with an ‘Access Denied’ message.

The first thing to note is that the **Add** button will not return a list of users in Samba (it will give an error message saying ‘The remote procedure call failed and did not execute’). This means that you can only manipulate the current user/group/world permissions listed in the dialog box. This actually works quite well as these are the only permissions that UNIX actually has.

If a permission triplet (either user, group, or world) is removed from the list of permissions in the NT dialog box, then when the **OK** button is pressed it will be applied as “*no permissions*” on the UNIX side. If you then view the permissions again, the “*no permissions*” entry will appear as the NT **O** flag, as described above. This allows you to add permissions back to a file or directory once you have removed them from a triplet component.

As UNIX supports only the “*r*”, “*w*” and “*x*” bits of an NT ACL, if other NT security attributes such as **Delete Access** are selected they will be ignored when applied on the Samba server.

When setting permissions on a directory, the second set of permissions (in the second set of parentheses) is by default applied to all files within that directory. If this is not what you want, you must un-check the **Replace permissions on existing files** check-box in the NT dialog before clicking on **OK**.

If you wish to remove all permissions from a user/group/world component, you may either highlight the component and click on the **Remove** button, or set the component to only

have the special **Take Ownership** permission (displayed as **O**) highlighted.

13.5.6 Interaction with the Standard Samba “*create mask*” Parameters

There are four parameters that control interaction with the standard Samba *create mask* parameters. These are:

- security mask
- force security mode
- directory security mask
- force directory security mode

Once a user clicks on **OK** to apply the permissions, Samba maps the given permissions into a user/group/world r/w/x triplet set, and then checks the changed permissions for a file against the bits set in the security mask parameter. Any bits that were changed that are not set to “1” in this parameter are left alone in the file permissions.

Essentially, zero bits in the security mask may be treated as a set of bits the user is *not* allowed to change, and one bits are those the user is allowed to change.

If not explicitly set, this parameter defaults to the same value as the create mask parameter. To allow a user to modify all the user/group/world permissions on a file, set this parameter to 0777.

Next Samba checks the changed permissions for a file against the bits set in the force security mode parameter. Any bits that were changed that correspond to bits set to “1” in this parameter are forced to be set.

Essentially, bits set in the *force security mode* parameter may be treated as a set of bits that, when modifying security on a file, the user has always set to be “on”.

If not explicitly set, this parameter defaults to the same value as the force create mode parameter. To allow a user to modify all the user/group/world permissions on a file with no restrictions set this parameter to 000. The security mask and *force security mode* parameters are applied to the change request in that order.

For a directory, Samba will perform the same operations as described above for a file except it uses the parameter *directory security mask* instead of *security mask*, and *force directory security mode* parameter instead of *force security mode*.

The directory security mask parameter by default is set to the same value as the *directory mask* parameter and the *force directory security mode* parameter by default is set to the same value as the force directory mode parameter. In this way Samba enforces the permission restrictions that an administrator can set on a Samba share, while still allowing users to modify the permission bits within that restriction.

If you want to set up a share that allows users full control in modifying the permission bits on their files and directories and does not force any particular bits to be set “on”, then set the following parameters in the `smb.conf` file in that share-specific section:

```
security mask = 0777  
force security mode = 0  
directory security mask = 0777  
force directory security mode = 0
```

13.5.7 Interaction with the Standard Samba File Attribute Mapping

NOTE



Samba maps some of the DOS attribute bits (such as “*read only*”) into the UNIX permissions of a file. This means there can be a conflict between the permission bits set via the security dialog and the permission bits set by the file attribute mapping.

If a file has no UNIX read access for the owner, it will show up as “*read only*” in the standard file attributes tabbed dialog. Unfortunately, this dialog is the same one that contains the security information in another tab.

What this can mean is that if the owner changes the permissions to allow himself read access using the security dialog, clicks on **OK** to get back to the standard attributes tab dialog, and clicks on **OK** on that dialog, then NT will set the file permissions back to read-only (as that is what the attributes still say in the dialog). This means that after setting permissions and clicking on **OK** to get back to the attributes dialog, you should always press **Cancel** rather than **OK** to ensure that your changes are not overridden.

13.6 Common Errors

File, directory and share access problems are common on the mailing list. The following are examples taken from the mailing list in recent times.

13.6.1 Users Cannot Write to a Public Share

*“We are facing some troubles with file/directory permissions. I can log on the domain as admin user(root), and there’s a public share on which everyone needs to have permission to create/modify files, but only root can change the file, no one else can. We need to constantly go to the server to `chgrp -R users *` and `chown -R nobody *` to allow others users to change the file.”*

There are many ways to solve this problem and here are a few hints:

1. Go to the top of the directory that is shared.
2. Set the ownership to what ever public owner and group you want

```
$ find 'directory_name' -type d -exec chown user.group {} \;  
$ find 'directory_name' -type d -exec chmod 1775 'directory_name'  
$ find 'directory_name' -type f -exec chmod 0775 {} \;  
$ find 'directory_name' -type f -exec chown user.group {} \;
```

NOTE



The above will set the sticky bit on all directories. Read your UNIX/Linux man page on what that does. It causes the OS to assign to all files created in the directories the ownership of the directory.

3. Directory is: */foodbar*

```
$ chown jack.engr /foodbar
```

NOTE



This is the same as doing:

```
$ chown jack /foodbar  
$ chgrp engr /foodbar
```

4. Now type:

```
$ chmod 6775 /foodbar  
$ ls -al /foodbar/..
```

You should see:

```
drwsrwsr-x  2 jack  engr    48 2003-02-04 09:55 foodbar
```

5. Now type:

```
$ su - jill
```

```
$ cd /foodbar
$ touch Afile
$ ls -al
```

You should see that the file `Afile` created by Jill will have ownership and permissions of Jack, as follows:

```
-rw-r--r--  1 jack  engr      0 2003-02-04 09:57 Afile
```

6. Now in your `smb.conf` for the share add:

```
force create mode = 0775
force directory mode = 6775
```

NOTE



These procedures are needed only if your users are not members of the group you have used. That is if within the OS do not have write permission on the directory.

An alternative is to set in the `smb.conf` entry for the share:

```
force user = jack
force group = engr
```

13.6.2 File Operations Done as `root` with `force user` Set

When you have a user in admin users, Samba will always do file operations for this user as `root`, even if `force user` has been set.

13.6.3 MS Word with Samba Changes Owner of File

Question: “When user `B` saves a word document that is owned by user `A` the updated file is now owned by user `B`. Why is Samba doing this? How do I fix this?”

Answer: Word does the following when you modify/change a Word document: MS Word creates a NEW document with a temporary name, Word then closes the old document and deletes it, Word then renames the new document to the original document name. There is no mechanism by which Samba can in any way know that the new document really should be owned by the owners of the original file. Samba has no way of knowing that the file will be renamed by MS Word. As far as Samba is able to tell, the file that gets created is a NEW file, not one that the application (Word) is updating.

There is a work-around to solve the permissions problem. That work-around involves understanding how you can manage file system behavior from within the `smb.conf` file, as well as understanding how UNIX file systems work. Set on the directory in which you are changing Word documents: `chmod g+s 'directory_name'` This ensures that all files will

be created with the group that owns the directory. In `smb.conf` share declaration section set:

```
force create mode = 0660  
force directory mode = 0770
```

These two settings will ensure that all directories and files that get created in the share will be read/writable by the owner and group set on the directory itself.

FILE AND RECORD LOCKING

One area that causes trouble for many network administrators is locking. The extent of the problem is readily evident from searches over the Internet.

14.1 Features and Benefits

Samba provides all the same locking semantics that MS Windows clients expect and that MS Windows NT4/200x servers also provide.

The term *locking* has exceptionally broad meaning and covers a range of functions that are all categorized under this one term.

Opportunistic locking is a desirable feature when it can enhance the perceived performance of applications on a networked client. However, the opportunistic locking protocol is not robust and, therefore, can encounter problems when invoked beyond a simplistic configuration or on extended slow or faulty networks. In these cases, operating system management of opportunistic locking and/or recovering from repetitive errors can offset the perceived performance advantage that it is intended to provide.

The MS Windows network administrator needs to be aware that file and record locking semantics (behavior) can be controlled either in Samba or by way of registry settings on the MS Windows client.

NOTE



Sometimes it is necessary to disable locking control settings on both the Samba server as well as on each MS Windows client!

14.2 Discussion

There are two types of locking that need to be performed by an SMB server. The first is *record locking* that allows a client to lock a range of bytes in an open file. The second is the *deny modes* that are specified when a file is open.

Record locking semantics under UNIX are very different from record locking under Windows. Versions of Samba before 2.2 have tried to use the native `fcntl()` UNIX system call to implement proper record locking between different Samba clients. This cannot be fully correct for several reasons. The simplest is the fact that a Windows client is allowed to lock a byte range up to 2^{32} or 2^{64} , depending on the client OS. The UNIX locking only supports byte ranges up to 2^{31} . So it is not possible to correctly satisfy a lock request above 2^{31} . There are many more differences, too many to be listed here.

Samba 2.2 and above implements record locking completely independent of the underlying UNIX system. If a byte range lock that the client requests happens to fall into the range of $0-2^{31}$, Samba hands this request down to the UNIX system. All other locks cannot be seen by UNIX, anyway.

Strictly speaking, an SMB server should check for locks before every read and write call on a file. Unfortunately with the way `fcntl()` works, this can be slow and may overstress the `rpc.lockd`. This is almost always unnecessary as clients are supposed to independently make locking calls before reads and writes if locking is important to them. By default, Samba only makes locking calls when explicitly asked to by a client, but if you set `strict locking = yes`, it will make lock checking calls on *every* read and write call.

You can also disable byte range locking completely by using `locking = no`. This is useful for those shares that do not support locking or do not need it (such as CDROMs). In this case, Samba fakes the return codes of locking calls to tell clients that everything is okay.

The second class of locking is the *deny modes*. These are set by an application when it opens a file to determine what types of access should be allowed simultaneously with its open. A client may ask for `DENY_NONE`, `DENY_READ`, `DENY_WRITE`, or `DENY_ALL`. There are also special compatibility modes called `DENY_FCB` and `DENY_DOS`.

14.2.1 Opportunistic Locking Overview

Opportunistic locking (Oplocks) is invoked by the Windows file system (as opposed to an API) via registry entries (on the server and the client) for the purpose of enhancing network performance when accessing a file residing on a server. Performance is enhanced by caching the file locally on the client that allows:

Read-ahead: The client reads the local copy of the file, eliminating network latency.

Write caching: The client writes to the local copy of the file, eliminating network latency.

Lock caching: The client caches application locks locally, eliminating network latency.

The performance enhancement of oplocks is due to the opportunity of exclusive access to the file — even if it is opened with deny-none — because Windows monitors the file’s status for concurrent access from other processes.

WINDOWS DEFINES 4 KINDS OF OPLOCKS:

Level1 Oplock The redirector sees that the file was opened with deny none (allowing concurrent access), verifies that no other process is accessing the file, checks that oplocks are enabled, then grants deny-all/read-write/exclusive access to the file. The client now performs operations on the cached local file.

If a second process attempts to open the file, the open is deferred while the redirector “breaks” the original oplock. The oplock break signals the caching client to write the local file back to the server, flush the local locks and discard read-ahead data. The break is then complete, the deferred open is granted, and the multiple processes can enjoy concurrent file access as dictated by mandatory or byte-range locking options. However, if the original opening process opened the file with a share mode other than deny-none, then the second process is granted limited or no access, despite the oplock break.

Level2 Oplock Performs like a Level1 oplock, except caching is only operative for reads. All other operations are performed on the server disk copy of the file.

Filter Oplock Does not allow write or delete file access.

Batch Oplock Manipulates file openings and closings and allows caching of file attributes.

An important detail is that oplocks are invoked by the file system, not an application API. Therefore, an application can close an oplocked file, but the file system does not relinquish the oplock. When the oplock break is issued, the file system then simply closes the file in preparation for the subsequent open by the second process.

Opportunistic locking is actually an improper name for this feature. The true benefit of this feature is client-side data caching, and oplocks is merely a notification mechanism for writing data back to the networked storage disk. The limitation of opportunistic locking is the reliability of the mechanism to process an oplock break (notification) between the server and the caching client. If this exchange is faulty (usually due to timing out for any number of reasons), then the client-side caching benefit is negated.

The actual decision that a user or administrator should consider is whether it is sensible to share among multiple users data that will be cached locally on a client. In many cases the answer is no. Deciding when to cache or not cache data is the real question, and thus “*opportunistic locking*” should be treated as a toggle for client-side caching. Turn it “*on*” when client-side caching is desirable and reliable. Turn it “*off*” when client-side caching is redundant, unreliable or counter-productive.

Opportunistic locking is by default set to “*on*” by Samba on all configured shares, so careful attention should be given to each case to determine if the potential benefit is worth the potential for delays. The following recommendations will help to characterize the environment

where opportunistic locking may be effectively configured.

Windows opportunistic locking is a lightweight performance-enhancing feature. It is not a robust and reliable protocol. Every implementation of opportunistic locking should be evaluated as a tradeoff between perceived performance and reliability. Reliability decreases as each successive rule above is not enforced. Consider a share with oplocks enabled, over a wide area network, to a client on a South Pacific atoll, on a high-availability server, serving a mission-critical multi-user corporate database during a tropical storm. This configuration will likely encounter problems with oplocks.

Oplocks can be beneficial to perceived client performance when treated as a configuration toggle for client-side data caching. If the data caching is likely to be interrupted, then oplock usage should be reviewed. Samba enables opportunistic locking by default on all shares. Careful attention should be given to the client usage of shared data on the server, the server network reliability and the opportunistic locking configuration of each share. In mission critical high availability environments, data integrity is often a priority. Complex and expensive configurations are implemented to ensure that if a client loses connectivity with a file server, a fail-over replacement will be available immediately to provide continuous data availability.

Windows client fail-over behavior is more at risk of application interruption than other platforms because it is dependent upon an established TCP transport connection. If the connection is interrupted — as in a file server fail-over — a new session must be established. It is rare for Windows client applications to be coded to recover correctly from a transport connection loss, therefore, most applications will experience some sort of interruption — at worst, abort and require restarting.

If a client session has been caching writes and reads locally due to opportunistic locking, it is likely that the data will be lost when the application restarts or recovers from the TCP interrupt. When the TCP connection drops, the client state is lost. When the file server recovers, an oplock break is not sent to the client. In this case, the work from the prior session is lost. Observing this scenario with oplocks disabled and with the client writing data to the file server real-time, the fail-over will provide the data on disk as it existed at the time of the disconnect.

In mission-critical high-availability environments, careful attention should be given to opportunistic locking. Ideally, comprehensive testing should be done with all affected applications with oplocks enabled and disabled.

14.2.1.1 Exclusively Accessed Shares

Opportunistic locking is most effective when it is confined to shares that are exclusively accessed by a single user, or by only one user at a time. Because the true value of opportunistic locking is the local client caching of data, any operation that interrupts the caching mechanism will cause a delay.

Home directories are the most obvious examples of where the performance benefit of opportunistic locking can be safely realized.

14.2.1.2 Multiple-Accessed Shares or Files

As each additional user accesses a file in a share with opportunistic locking enabled, the potential for delays and resulting perceived poor performance increases. When multiple users are accessing a file on a share that has oplocks enabled, the management impact of sending and receiving oplock breaks and the resulting latency while other clients wait for the caching client to flush data offset the performance gains of the caching user.

As each additional client attempts to access a file with oplocks set, the potential performance improvement is negated and eventually results in a performance bottleneck.

14.2.1.3 UNIX or NFS Client-Accessed Files

Local UNIX and NFS clients access files without a mandatory file-locking mechanism. Thus, these client platforms are incapable of initiating an oplock break request from the server to a Windows client that has a file cached. Local UNIX or NFS file access can therefore write to a file that has been cached by a Windows client, which exposes the file to likely data corruption.

If files are shared between Windows clients, and either local UNIX or NFS users, turn opportunistic locking off.

14.2.1.4 Slow and/or Unreliable Networks

The biggest potential performance improvement for opportunistic locking occurs when the client-side caching of reads and writes delivers the most differential over sending those reads and writes over the wire. This is most likely to occur when the network is extremely slow, congested, or distributed (as in a WAN). However, network latency also has a high impact on the reliability of the oplock break mechanism, and thus increases the likelihood of encountering oplock problems that more than offset the potential perceived performance gain. Of course, if an oplock break never has to be sent, then this is the most advantageous scenario to utilize opportunistic locking.

If the network is slow, unreliable, or a WAN, then do not configure opportunistic locking if there is any chance of multiple users regularly opening the same file.

14.2.1.5 Multi-User Databases

Multi-user databases clearly pose a risk due to their very nature — they are typically heavily accessed by numerous users at random intervals. Placing a multi-user database on a share with opportunistic locking enabled will likely result in a locking management bottleneck on the Samba server. Whether the database application is developed in-house or a commercially available product, ensure that the share has opportunistic locking disabled.

14.2.1.6 PDM Data Shares

Process Data Management (PDM) applications such as IMAN, Enovia and Clearcase are increasing in usage with Windows client platforms, and therefore SMB data-stores. PDM

applications manage multi-user environments for critical data security and access. The typical PDM environment is usually associated with sophisticated client design applications that will load data locally as demanded. In addition, the PDM application will usually monitor the data-state of each client. In this case, client-side data caching is best left to the local application and PDM server to negotiate and maintain. It is appropriate to eliminate the client OS from any caching tasks, and the server from any oplock management, by disabling opportunistic locking on the share.

14.2.1.7 Beware of Force User

Samba includes an `smb.conf` parameter called `force user` that changes the user accessing a share from the incoming user to whatever user is defined by the `smb.conf` variable. If opportunistic locking is enabled on a share, the change in user access causes an oplock break to be sent to the client, even if the user has not explicitly loaded a file. In cases where the network is slow or unreliable, an oplock break can become lost without the user even accessing a file. This can cause apparent performance degradation as the client continually reconnects to overcome the lost oplock break.

Avoid the combination of the following:

- `force user` in the `smb.conf` share configuration.
- Slow or unreliable networks
- Opportunistic locking enabled

14.2.1.8 Advanced Samba Opportunistic Locking Parameters

Samba provides opportunistic locking parameters that allow the administrator to adjust various properties of the oplock mechanism to account for timing and usage levels. These parameters provide good versatility for implementing oplocks in environments where they would likely cause problems. The parameters are: oplock break wait time, oplock contention limit.

For most users, administrators and environments, if these parameters are required, then the better option is to simply turn oplocks off. The Samba SWAT help text for both parameters reads: *“Do not change this parameter unless you have read and understood the Samba oplock code.”* This is good advice.

14.2.1.9 Mission-Critical High-Availability

In mission-critical high-availability environments, data integrity is often a priority. Complex and expensive configurations are implemented to ensure that if a client loses connectivity with a file server, a fail-over replacement will be available immediately to provide continuous data availability.

Windows client fail-over behavior is more at risk of application interruption than other platforms because it is dependant upon an established TCP transport connection. If the connection is interrupted — as in a file server fail-over — a new session must be established. It is rare for Windows client applications to be coded to recover correctly from a transport

connection loss, therefore, most applications will experience some sort of interruption — at worst, abort and require restarting.

If a client session has been caching writes and reads locally due to opportunistic locking, it is likely that the data will be lost when the application restarts, or recovers from the TCP interrupt. When the TCP connection drops, the client state is lost. When the file server recovers, an oplock break is not sent to the client. In this case, the work from the prior session is lost. Observing this scenario with oplocks disabled, and the client was writing data to the file server real-time, then the fail-over will provide the data on disk as it existed at the time of the disconnect.

In mission-critical high-availability environments, careful attention should be given to opportunistic locking. Ideally, comprehensive testing should be done with all effected applications with oplocks enabled and disabled.

14.3 Samba Opportunistic Locking Control

Opportunistic locking is a unique Windows file locking feature. It is not really file locking, but is included in most discussions of Windows file locking, so is considered a de facto locking feature. Opportunistic locking is actually part of the Windows client file caching mechanism. It is not a particularly robust or reliable feature when implemented on the variety of customized networks that exist in enterprise computing.

Like Windows, Samba implements opportunistic locking as a server-side component of the client caching mechanism. Because of the lightweight nature of the Windows feature design, effective configuration of opportunistic locking requires a good understanding of its limitations, and then applying that understanding when configuring data access for each particular customized network and client usage state.

Opportunistic locking essentially means that the client is allowed to download and cache a file on their hard drive while making changes; if a second client wants to access the file, the first client receives a break and must synchronize the file back to the server. This can give significant performance gains in some cases; some programs insist on synchronizing the contents of the entire file back to the server for a single change.

Level1 Oplocks (also known as just plain “*oplocks*”) is another term for opportunistic locking.

Level2 Oplocks provides opportunistic locking for a file that will be treated as *read only*. Typically this is used on files that are read-only or on files that the client has no initial intention to write to at time of opening the file.

Kernel Oplocks are essentially a method that allows the Linux kernel to co-exist with Samba’s oplocked files, although this has provided better integration of MS Windows network file locking with the underlying OS, SGI IRIX and Linux are the only two OSs that are oplock-aware at this time.

Unless your system supports kernel oplocks, you should disable oplocks if you are accessing the same files from both UNIX/Linux and SMB clients. Regardless, oplocks should always be disabled if you are sharing a database file (e.g., Microsoft Access) between multiple clients, as any break the first client receives will affect synchronization of the entire file (not just the single record), which will result in a noticeable performance impairment and,

more likely, problems accessing the database in the first place. Notably, Microsoft Outlook's personal folders (*.pst) react quite badly to oplocks. If in doubt, disable oplocks and tune your system from that point.

If client-side caching is desirable and reliable on your network, you will benefit from turning on oplocks. If your network is slow and/or unreliable, or you are sharing your files among other file sharing mechanisms (e.g., NFS) or across a WAN, or multiple people will be accessing the same files frequently, you probably will not benefit from the overhead of your client sending oplock breaks and will instead want to disable oplocks for the share.

Another factor to consider is the perceived performance of file access. If oplocks provide no measurable speed benefit on your network, it might not be worth the hassle of dealing with them.

14.3.1 Example Configuration

In the following section we examine two distinct aspects of Samba locking controls.

14.3.1.1 Disabling Oplocks

You can disable oplocks on a per-share basis with the following:

```
[acctdata]
    oplocks = False
    level2 oplocks = False
```

The default oplock type is Level1. Level2 oplocks are enabled on a per-share basis in the `smb.conf` file.

Alternately, you could disable oplocks on a per-file basis within the share:

```
veto oplock files = /*.mdb/*.MDB/*.dbf/*.DBF/
```

If you are experiencing problems with oplocks as apparent from Samba's log entries, you may want to play it safe and disable oplocks and Level2 oplocks.

14.3.1.2 Disabling Kernel Oplocks

Kernel oplocks is an `smb.conf` parameter that notifies Samba (if the UNIX kernel has the capability to send a Windows client an oplock break) when a UNIX process is attempting to open the file that is cached. This parameter addresses sharing files between UNIX and Windows with oplocks enabled on the Samba server: the UNIX process can open the file that is Oplocked (cached) by the Windows client and the `smbd` process will not send an oplock break, which exposes the file to the risk of data corruption. If the UNIX kernel has the ability to send an oplock break, then the kernel oplocks parameter enables Samba to send the oplock break. Kernel oplocks are enabled on a per-server basis in the `smb.conf` file.

```
kernel oplocks = yes The default is no.
```

Veto opLocks is an `smb.conf` parameter that identifies specific files for which oplocks are disabled. When a Windows client opens a file that has been configured for veto oplocks, the client will not be granted the oplock, and all operations will be executed on the original file on disk instead of a client-cached file copy. By explicitly identifying files that are shared with UNIX processes and disabling oplocks for those files, the server-wide Oplock configuration can be enabled to allow Windows clients to utilize the performance benefit of file caching without the risk of data corruption. Veto Oplocks can be enabled on a per-share basis, or globally for the entire server, in the `smb.conf` file as shown in Example 14.3.1.

Example 14.3.1. Share with some files oplocked

```
[global]
    veto oplock files = /filename.htm/*.txt/

[share_name]
    veto oplock files = /*.exe/filename.ext/
```

oplock break wait time is an `smb.conf` parameter that adjusts the time interval for Samba to reply to an oplock break request. Samba recommends: “*Do not change this parameter unless you have read and understood the Samba oplock code.*” Oplock break Wait Time can only be configured globally in the `smb.conf` file as shown below.

```
oplock break wait time = 0 (default)
```

Oplock break contention limit is an `smb.conf` parameter that limits the response of the Samba server to grant an oplock if the configured number of contending clients reaches the limit specified by the parameter. Samba recommends “*Do not change this parameter unless you have read and understood the Samba oplock code.*” Oplock break Contention Limit can be enable on a per-share basis, or globally for the entire server, in the `smb.conf` file as shown in Example 14.3.2.

Example 14.3.2. Configuration with oplock break contention limit

```
[global]
    oplock break contention limit = 2 (default)

[share_name]
    oplock break contention limit = 2 (default)
```

14.4 MS Windows Opportunistic Locking and Caching Controls

There is a known issue when running applications (like Norton Anti-Virus) on a Windows 2000/ XP workstation computer that can affect any application attempting to access shared database files across a network. This is a result of a default setting configured in the Windows 2000/XP operating system known as *opportunistic locking*. When a workstation attempts to access shared data files located on another Windows 2000/XP computer, the

Windows 2000/XP operating system will attempt to increase performance by locking the files and caching information locally. When this occurs, the application is unable to properly function, which results in an “*Access Denied*” error message being displayed during network operations.

All Windows operating systems in the NT family that act as database servers for data files (meaning that data files are stored there and accessed by other Windows PCs) may need to have opportunistic locking disabled in order to minimize the risk of data file corruption. This includes Windows 9x/Me, Windows NT, Windows 200x, and Windows XP.¹

If you are using a Windows NT family workstation in place of a server, you must also disable opportunistic locking (oplocks) on that workstation. For example, if you use a PC with the Windows NT Workstation operating system instead of Windows NT Server, and you have data files located on it that are accessed from other Windows PCs, you may need to disable oplocks on that system.

The major difference is the location in the Windows registry where the values for disabling oplocks are entered. Instead of the LanManServer location, the LanManWorkstation location may be used.

You can verify (change or add, if necessary) this registry value using the Windows Registry Editor. When you change this registry value, you will have to reboot the PC to ensure that the new setting goes into effect.

The location of the client registry entry for opportunistic locking has changed in Windows 2000 from the earlier location in Microsoft Windows NT.

NOTE



Windows 2000 will still respect the EnableOplocks registry value used to disable oplocks in earlier versions of Windows.

You can also deny the granting of opportunistic locks by changing the following registry entries:

```
HKEY_LOCAL_MACHINE\System\  
  CurrentControlSet\Services\MRXSmb\Parameters\  
  
  OplocksDisabled REG_DWORD 0 or 1  
  Default: 0 (not disabled)
```

¹Microsoft has documented this in Knowledge Base article 300216.

NOTE



The `OplocksDisabled` registry value configures Windows clients to either request or not request opportunistic locks on a remote file. To disable oplocks, the value of `OplocksDisabled` must be set to 1.

```
HKEY_LOCAL_MACHINE\System\  
CurrentControlSet\Services\LanmanServer\Parameters
```

```
EnableOplocks REG_DWORD 0 or 1  
Default: 1 (Enabled by Default)
```

```
EnableOpLockForceClose REG_DWORD 0 or 1  
Default: 0 (Disabled by Default)
```

NOTE



The `EnableOplocks` value configures Windows-based servers (including Workstations sharing files) to allow or deny opportunistic locks on local files.

To force closure of open oplocks on close or program exit, `EnableOpLockForceClose` must be set to 1.

An illustration of how Level2 oplocks work:

- Station 1 opens the file requesting oplock.
- Since no other station has the file open, the server grants station 1 exclusive oplock.
- Station 2 opens the file requesting oplock.
- Since station 1 has not yet written to the file, the server asks station 1 to break to Level2 oplock.
- Station 1 complies by flushing locally buffered lock information to the server.
- Station 1 informs the server that it has Broken to Level2 Oplock (alternately, station 1 could have closed the file).
- The server responds to station 2's open request, granting it Level2 oplock. Other stations can likewise open the file and obtain Level2 oplock.
- Station 2 (or any station that has the file open) sends a write request SMB. The server returns the write response.

- The server asks all stations that have the file open to break to none, meaning no station holds any oplock on the file. Because the workstations can have no cached writes or locks at this point, they need not respond to the break-to-none advisory; all they need do is invalidate locally cached read-ahead data.

14.4.1 Workstation Service Entries

```

\HKEY_LOCAL_MACHINE\System\
  CurrentControlSet\Services\LanmanWorkstation\Parameters

UseOpportunisticLocking  REG_DWORD  0 or 1
Default: 1 (true)

```

This indicates whether the redirector should use opportunistic-locking (oplock) performance enhancement. This parameter should be disabled only to isolate problems.

14.4.2 Server Service Entries

```

\HKEY_LOCAL_MACHINE\System\
  CurrentControlSet\Services\LanmanServer\Parameters

EnableOplocks  REG_DWORD  0 or 1
Default: 1 (true)

```

This specifies whether the server allows clients to use oplocks on files. Oplocks are a significant performance enhancement, but have the potential to cause lost cached data on some networks, particularly wide area networks.

```

MinLinkThroughput  REG_DWORD  0 to infinite bytes per second
Default: 0

```

This specifies the minimum link throughput allowed by the server before it disables raw and opportunistic locks for this connection.

```

MaxLinkDelay  REG_DWORD  0 to 100,000 seconds
Default: 60

```

This specifies the maximum time allowed for a link delay. If delays exceed this number, the server disables raw I/O and opportunistic locking for this connection.

```

OplockBreakWait  REG_DWORD  10 to 180 seconds

```

Default: 35

This specifies the time that the server waits for a client to respond to an oplock break request. Smaller values can allow detection of crashed clients more quickly but can potentially cause loss of cached data.

14.5 Persistent Data Corruption

If you have applied all of the settings discussed in this chapter but data corruption problems and other symptoms persist, here are some additional things to check out.

We have credible reports from developers that faulty network hardware, such as a single faulty network card, can cause symptoms similar to read caching and data corruption. If you see persistent data corruption even after repeated re-indexing, you may have to rebuild the data files in question. This involves creating a new data file with the same definition as the file to be rebuilt and transferring the data from the old file to the new one. There are several known methods for doing this that can be found in our Knowledge Base.

14.6 Common Errors

In some sites, locking problems surface as soon as a server is installed; in other sites locking problems may not surface for a long time. Almost without exception, when a locking problem does surface it will cause embarrassment and potential data corruption.

Over the past few years there have been a number of complaints on the Samba mailing lists that have claimed that Samba caused data corruption. Three causes have been identified so far:

- Incorrect configuration of opportunistic locking (incompatible with the application being used. This is a common problem even where MS Windows NT4 or MS Windows 200x-based servers were in use. It is imperative that the software application vendors' instructions for configuration of file locking should be followed. If in doubt, disable oplocks on both the server and the client. Disabling of all forms of file caching on the MS Windows client may be necessary also.
- Defective network cards, cables, or HUBs/Switched. This is generally a more prevalent factor with low cost networking hardware, although occasionally there have also been problems with incompatibilities in more up-market hardware.
- There have been some random reports of Samba log files being written over data files. This has been reported by very few sites (about five in the past three years) and all attempts to reproduce the problem have failed. The Samba Team has been unable to catch this happening and thus has not been able to isolate any particular cause. Considering the millions of systems that use Samba, for the sites that have been affected by this as well as for the Samba Team this is a frustrating and a vexing challenge. If you see this type of thing happening, please create a bug report on Samba Bugzilla <<https://bugzilla.samba.org>> without delay. Make sure that you give

as much information as you possibly can help isolate the cause and to allow replication of the problem (an essential step in problem isolation and correction).

14.6.1 locking.tdb Error Messages

“We are seeing lots of errors in the Samba logs, like:

```
tdb(/usr/local/samba_2.2.7/var/locks/locking.tdb): rec_read bad magic
0x4d6f4b61 at offset=36116
```

What do these mean?”

This error indicated a corrupted tdb. Stop all instances of smbd, delete locking.tdb, and restart smbd.

14.6.2 Problems Saving Files in MS Office on Windows XP

This is a bug in Windows XP. More information can be found in Microsoft Knowledge Base article 812937. <<http://support.microsoft.com/?id=812937>>

14.6.3 Long Delays Deleting Files Over Network with XP SP1

“It sometimes takes approximately 35 seconds to delete files over the network after XP SP1 has been applied.”

This is a bug in Windows XP. More information can be found in Microsoft Knowledge Base article 811492. <<http://support.microsoft.com/?id=811492>>

14.7 Additional Reading

You may want to check for an updated version of this white paper on our Web site from time to time. Many of our white papers are updated as information changes. For those papers, the last edited date is always at the top of the paper.

Section of the Microsoft MSDN Library on opportunistic locking:

Opportunistic Locks, Microsoft Developer Network (MSDN), Windows Development > Windows Base Services > Files and I/O > SDK Documentation > File Storage > File Systems > About File Systems > Opportunistic Locks, Microsoft Corporation. <http://msdn.microsoft.com/library/en-us/fileio/storage_5yk3.asp>

Microsoft Knowledge Base Article Q224992 “*Maintaining Transactional Integrity with OPLOCKS*”, Microsoft Corporation, April 1999, <<http://support.microsoft.com/default.aspx?scid=kb;en-us;Q224992>>.

Microsoft Knowledge Base Article Q296264 “*Configuring Opportunistic Locking in Windows 2000*”, Microsoft Corporation, April 2001, <<http://support.microsoft.com/default.aspx?scid=kb;en-us;Q296264>>.

Microsoft Knowledge Base Article Q129202 “*PC Ext: Explanation of Opportunistic Locking on Windows NT*”, Microsoft Corporation, April 1995, <<http://support.microsoft.com/default.aspx?scid=kb;en-us;Q129202>>.

SECURING SAMBA

15.1 Introduction

This note was attached to the Samba 2.2.8 release notes as it contained an important security fix. The information contained here applies to Samba installations in general.

A new apprentice reported for duty to the chief engineer of a boiler house. He said, “*Here I am, if you will show me the boiler I’ll start working on it.*” Then engineer replied, “*You’re leaning on it!*”

Security concerns are just like that. You need to know a little about the subject to appreciate how obvious most of it really is. The challenge for most of us is to discover that first morsel of knowledge with which we may unlock the secrets of the masters.

15.2 Features and Benefits

There are three levels at which security principals must be observed in order to render a site at least moderately secure. They are the perimeter firewall, the configuration of the host server that is running Samba and Samba itself.

Samba permits a most flexible approach to network security. As far as possible Samba implements the latest protocols to permit more secure MS Windows file and print operations.

Samba may be secured from connections that originate from outside the local network. This may be done using *host-based protection* (using Samba’s implementation of a technology known as “*tcpwrappers*,” or it may be done by using *interface-based exclusion* so `smbd` will bind only to specifically permitted interfaces. It is also possible to set specific share or resource-based exclusions, for example on the `[IPC$]` auto-share. The `[IPC$]` share is used for browsing purposes as well as to establish TCP/IP connections.

Another method by which Samba may be secured is by setting Access Control Entries (ACEs) in an Access Control List (ACL) on the shares themselves. This is discussed in File, Directory and Share Access Controls.

15.3 Technical Discussion of Protective Measures and Issues

The key challenge of security is the fact that protective measures suffice at best only to close the door on known exploits and breach techniques. Never assume that because you have followed these few measures that the Samba server is now an impenetrable fortress! Given the history of information systems so far, it is only a matter of time before someone will find yet another vulnerability.

15.3.1 Using Host-Based Protection

In many installations of Samba, the greatest threat comes from outside your immediate network. By default, Samba will accept connections from any host, which means that if you run an insecure version of Samba on a host that is directly connected to the Internet you can be especially vulnerable.

One of the simplest fixes in this case is to use the `hosts allow` and `hosts deny` options in the Samba `smb.conf` configuration file to only allow access to your server from a specific range of hosts. An example might be:

```
hosts allow = 127.0.0.1 192.168.2.0/24 192.168.3.0/24
hosts deny = 0.0.0.0/0
```

The above will only allow SMB connections from `localhost` (your own computer) and from the two private networks 192.168.2 and 192.168.3. All other connections will be refused as soon as the client sends its first packet. The refusal will be marked as not listening or called name error.

15.3.2 User-Based Protection

If you want to restrict access to your server to valid users only, then the following method may be of use. In the `smb.conf` `[global]` section put:

```
valid users = @smbusers, jacko
```

This restricts all server access to either the user `jacko` or to members of the system group `smbusers`.

15.3.3 Using Interface Protection

By default, Samba will accept connections on any network interface that it finds on your system. That means if you have a ISDN line or a PPP connection to the Internet then Samba will accept connections on those links. This may not be what you want.

You can change this behavior using options like this:

```
interfaces = eth* lo
bind interfaces only = yes
```

This tells Samba to only listen for connections on interfaces with a name starting with `eth` such as `eth0`, `eth1` plus on the loopback interface called `lo`. The name you will need to

use depends on what OS you are using. In the above, I used the common name for Ethernet adapters on Linux.

If you use the above and someone tries to make an SMB connection to your host over a PPP interface called `ppp0`, then they will get a TCP connection refused reply. In that case, no Samba code is run at all as the operating system has been told not to pass connections from that interface to any Samba process.

15.3.4 Using a Firewall

Many people use a firewall to deny access to services they do not want exposed outside their network. This can be a good idea, although I recommend using it in conjunction with the above methods so you are protected even if your firewall is not active for some reason.

If you are setting up a firewall, you need to know what TCP and UDP ports to allow and block. Samba uses the following:

- UDP/137 - used by nmbd
- UDP/138 - used by nmbd
- TCP/139 - used by smbd
- TCP/445 - used by smbd

The last one is important as many older firewall setups may not be aware of it, given that this port was only added to the protocol in recent years.

15.3.5 Using IPC\$ Share-Based Denials

If the above methods are not suitable, then you could also place a more specific deny on the IPC\$ share that is used in the recently discovered security hole. This allows you to offer access to other shares while denying access to IPC\$ from potentially un-trustworthy hosts.

To do this you could use:

```
[IPC$]
hosts allow = 192.168.115.0/24 127.0.0.1
hosts deny = 0.0.0.0/0
```

This instructs Samba that IPC\$ connections are not allowed from anywhere except from the two listed network addresses (localhost and the 192.168.115 subnet). Connections to other shares are still allowed. As the IPC\$ share is the only share that is always accessible anonymously, this provides some level of protection against attackers that do not know a valid username/password for your host.

If you use this method, then clients will be given an ‘access denied’ reply when they try to access the IPC\$ share. Those clients will not be able to browse shares, and may also be unable to access some other resources. This is not recommended unless you cannot use one of the other methods listed above for some reason.

15.3.6 NTLMv2 Security

To configure NTLMv2 authentication, the following registry keys are worth knowing about:

```
[HKEY_LOCAL_MACHINE\SYSTEM\CurrentControlSet\Control\Lsa]
"lmcompatibilitylevel"=dword:00000003
```

The value 0x00000003 means send NTLMv2 response only. Clients will use NTLMv2 authentication, use NTLMv2 session security if the server supports it. Domain Controllers accept LM, NTLM and NTLMv2 authentication.

```
[HKEY_LOCAL_MACHINE\SYSTEM\CurrentControlSet\Control\Lsa\MSV1_0]
"NtlmMinClientSec"=dword:00080000
```

The value 0x00080000 means permit only NTLMv2 session security. If either NtlmMinClientSec or NtlmMinServerSec is set to 0x00080000, the connection will fail if NTLMv2 session security is not negotiated.

15.4 Upgrading Samba

Please check regularly on <http://www.samba.org/> for updates and important announcements. Occasionally security releases are made and it is highly recommended to upgrade Samba when a security vulnerability is discovered. Check with your OS vendor for OS specific upgrades.

15.5 Common Errors

If all of Samba and host platform configuration were really as intuitive as one might like them to be, this section would not be necessary. Security issues are often vexing for a support person to resolve, not because of the complexity of the problem, but for the reason that most administrators who post what turns out to be a security problem request are totally convinced that the problem is with Samba.

15.5.1 Smbclient Works on Localhost, but the Network Is Dead

This is a common problem. Red Hat Linux (and others) installs a default firewall. With the default firewall in place, only traffic on the loopback adapter (IP address 127.0.0.1) is allowed through the firewall.

The solution is either to remove the firewall (stop it) or modify the firewall script to allow SMB networking traffic through. See section above in this chapter.

15.5.2 Why Can Users Access Home Directories of Other Users?

“We are unable to keep individual users from mapping to any other user’s home directory once they have supplied a valid password! They only need to enter their own password. I have not found any method to configure Samba so that users may map only their own home directory.”

“User xyzzy can map his home directory. Once mapped user xyzzy can also map anyone else’s home directory.”

This is not a security flaw, it is by design. Samba allows users to have exactly the same access to the UNIX file system as when they were logged onto the UNIX box, except that it only allows such views onto the file system as are allowed by the defined shares.

If your UNIX home directories are set up so that one user can happily **cd** into another users directory and execute **ls**, the UNIX security solution is to change file permissions on the user’s home directories such that the **cd** and **ls** are denied.

Samba tries very hard not to second guess the UNIX administrators security policies, and trusts the UNIX admin to set the policies and permissions he or she desires.

Samba allows the behavior you require. Simply put the only user = %S option in the *[homes]* share definition.

The only user works in conjunction with the users = list, so to get the behavior you require, add the line : `users = %S` this is equivalent to adding `valid users = %S` to the definition of the *[homes]* share, as recommended in the `smb.conf` man page.

INTERDOMAIN TRUST RELATIONSHIPS

Samba-3 supports NT4-style domain trust relationships. This is a feature that many sites will want to use if they migrate to Samba-3 from an NT4-style domain and do not want to adopt Active Directory or an LDAP-based authentication backend. This section explains some background information regarding trust relationships and how to create them. It is now possible for Samba-3 to trust NT4 (and vice versa), as well as to create Samba-to-Samba trusts.

The use of interdomain trusts requires use of **winbind**. Thus the **winbindd** daemon must be running. Winbind operation in this mode is dependant on the specification of a valid UID range and a valid GID range in the `smb.conf` file. These are specified respectively using `idmap uid = 10000-20000` and `idmap gid = 10000-20000`.

NOTE



The use of winbind is necessary only when Samba is the trusting Domain, not when it is the trusted Domain.

16.1 Features and Benefits

Samba-3 can participate in Samba-to-Samba as well as in Samba-to-MS Windows NT4-style trust relationships. This imparts to Samba similar scalability as with MS Windows NT4.

Given that Samba-3 has the capability to function with a scalable backend authentication database such as LDAP, and given its ability to run in Primary as well as Backup Domain Control modes, the administrator would be well advised to consider alternatives to the use of Interdomain trusts simply because by the very nature of how this works it is fragile. That was, after all, a key reason for the development and adoption of Microsoft Active Directory.

16.2 Trust Relationship Background

MS Windows NT3/4 type security domains employ a non-hierarchical security structure. The limitations of this architecture as it effects the scalability of MS Windows networking in large organizations is well known. Additionally, the flat namespace that results from this design significantly impacts the delegation of administrative responsibilities in large and diverse organizations.

Microsoft developed Active Directory Service (ADS), based on Kerberos and LDAP, as a means of circumventing the limitations of the older technologies. Not every organization is ready or willing to embrace ADS. For small companies the older NT4-style domain security paradigm is quite adequate, there remains an entrenched user base for whom there is no direct desire to go through a disruptive change to adopt ADS.

With MS Windows NT, Microsoft introduced the ability to allow differing security domains to effect a mechanism so users from one domain may be given access rights and privileges in another domain. The language that describes this capability is couched in terms of *Trusts*. Specifically, one domain will *trust* the users from another domain. The domain from which users are available to another security domain is said to be a trusted domain. The domain in which those users have assigned rights and privileges is the trusting domain. With NT3.x/4.0 all trust relationships are always in one direction only, thus if users in both domains are to have privileges and rights in each others' domain, then it is necessary to establish two relationships, one in each direction.

In an NT4-style MS security domain, all trusts are non-transitive. This means that if there are three domains (let's call them RED, WHITE and BLUE) where RED and WHITE have a trust relationship, and WHITE and BLUE have a trust relationship, then it holds that there is no implied trust between the RED and BLUE domains. Relationships are explicit and not transitive.

New to MS Windows 2000 ADS security contexts is the fact that trust relationships are two-way by default. Also, all inter-ADS domain trusts are transitive. In the case of the RED, WHITE and BLUE domains above, with Windows 2000 and ADS the RED and BLUE domains can trust each other. This is an inherent feature of ADS domains. Samba-3 implements MS Windows NT4-style Interdomain trusts and interoperates with MS Windows 200x ADS security domains in similar manner to MS Windows NT4-style domains.

16.3 Native MS Windows NT4 Trusts Configuration

There are two steps to creating an interdomain trust relationship. To effect a two-way trust relationship, it is necessary for each domain administrator to create a trust account for the other domain to use in verifying security credentials.

16.3.1 Creating an NT4 Domain Trust

For MS Windows NT4, all domain trust relationships are configured using the Domain User Manager. This is done from the Domain User Manager Policies entry on the menu bar. From the **Policy** menu, select **Trust Relationships**. Next to the lower box labeled **Permitted to**

Trust this Domain are two buttons, **Add** and **Remove**. The **Add** button will open a panel in which to enter the name of the remote domain that will be able to assign access rights to users in your domain. You will also need to enter a password for this trust relationship, which the trusting domain will use when authenticating users from the trusted domain. The password needs to be typed twice (for standard confirmation).

16.3.2 Completing an NT4 Domain Trust

A trust relationship will work only when the other (trusting) domain makes the appropriate connections with the trusted domain. To consummate the trust relationship, the administrator will launch the Domain User Manager from the menu select **Policies**, then select **Trust Relationships**, click on the **Add** button next to the box that is labeled **Trusted Domains**. A panel will open in which must be entered the name of the remote domain as well as the password assigned to that trust.

16.3.3 Inter-Domain Trust Facilities

A two-way trust relationship is created when two one-way trusts are created, one in each direction. Where a one-way trust has been established between two MS Windows NT4 domains (let's call them DomA and DomB), the following facilities are created:

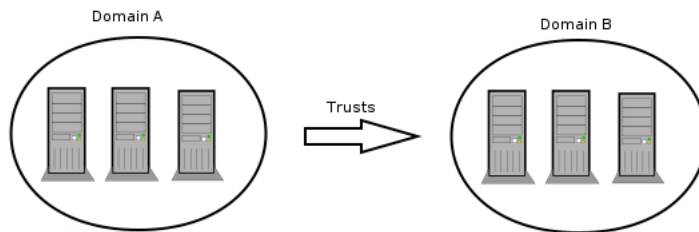

Figure 16.1. Trusts overview.

- DomA (completes the trust connection) *Trusts* DomB.
- DomA is the *Trusting* domain.
- DomB is the *Trusted* domain (originates the trust account).
- Users in DomB can access resources in DomA.
- Users in DomA cannot access resources in DomB.
- Global groups from DomB can be used in DomA.
- Global groups from DomA cannot be used in DomB.
- DomB does appear in the logon dialog box on client workstations in DomA.
- DomA does not appear in the logon dialog box on client workstations in DomB.
- Users/Groups in a trusting domain cannot be granted rights, permissions or access to a trusted domain.

- The trusting domain can access and use accounts (Users/Global Groups) in the trusted domain.
- Administrators of the trusted domain can be granted administrative rights in the trusting domain.
- Users in a trusted domain can be given rights and privileges in the trusting domain.
- Trusted domain Global Groups can be given rights and permissions in the trusting domain.
- Global Groups from the trusted domain can be made members in Local Groups on MS Windows Domain Member machines.

16.4 Configuring Samba NT-Style Domain Trusts

This description is meant to be a fairly short introduction about how to set up a Samba server so that it can participate in interdomain trust relationships. Trust relationship support in Samba is at an early stage, so do not be surprised if something does not function as it should.

Each of the procedures described below assumes the peer domain in the trust relationship is controlled by a Windows NT4 server. However, the remote end could just as well be another Samba-3 domain. It can be clearly seen, after reading this document, that combining Samba-specific parts of what's written below leads to trust between domains in a purely Samba environment.

16.4.1 Samba as the Trusted Domain

In order to set the Samba PDC to be the trusted party of the relationship, you first need to create a special account for the domain that will be the trusting party. To do that, you can use the **smbpasswd** utility. Creating the trusted domain account is similar to creating a trusted machine account. Suppose, your domain is called SAMBA, and the remote domain is called RUMBA. The first step will be to issue this command from your favorite shell:

```
root# smbpasswd -a -i rumba
New SMB password: XXXXXXXX
Retype SMB password: XXXXXXXX
Added user rumba$
```

where **-a** means to add a new account into the `passwd` database and **-i** means: “*create this account with the Inter-Domain trust flag*”.

The account name will be “*rumba\$*” (the name of the remote domain). If this fails, you should check that the trust account has been added to the system password database (`/etc/passwd`). If it has not been added, you can add it manually and then repeat the step above.

After issuing this command, you will be asked to enter the password for the account. You can use any password you want, but be aware that Windows NT will not change this password until seven days following account creation. After the command returns successfully, you can look at the entry for the new account (in the standard way as appropriate for your configuration) and see that accounts name is really RUMBA\$ and it has the “*T*” flag set in the flags field. Now you are ready to confirm the trust by establishing it from Windows NT Server.

Open User Manager for Domains and from the **Policies** menu, select **Trust Relationships...** Beside the **Trusted domains** list box click the **Add...** button. You will be prompted for the trusted domain name and the relationship password. Type in SAMBA, as this is the name of the remote domain and the password used at the time of account creation. Click on **OK** and, if everything went without incident, you will see the **Trusted domain relationship successfully established** message.

16.4.2 Samba as the Trusting Domain

This time activities are somewhat reversed. Again, we’ll assume that your domain controlled by the Samba PDC is called SAMBA and the NT-controlled domain is called RUMBA.

The very first step is to add an account for the SAMBA domain on RUMBA’s PDC.

Launch the Domain User Manager, then from the menu select **Policies, Trust Relationships**. Now, next to the **Trusted Domains** box press the **Add** button and type in the name of the trusted domain (SAMBA) and the password to use in securing the relationship.

The password can be arbitrarily chosen. It is easy to change the password from the Samba server whenever you want. After confirming the password your account is ready for use. Now its Samba’s turn.

Using your favorite shell while being logged in as root, issue this command:

```
root#net rpc trustdom establish rumba
```

You will be prompted for the password you just typed on your Windows NT4 Server box. An error message ‘NT_STATUS_NOLOGON_INTERDOMAIN_TRUST_ACCOUNT’ that may be reported periodically is of no concern and may safely be ignored. It means the password you gave is correct and the NT4 Server says the account is ready for interdomain connection and not for ordinary connection. After that, be patient; it can take a while (especially in large networks), but eventually you should see the **Success** message. Congratulations! Your trust relationship has just been established.

NOTE



You have to run this command as root because you must have write access to the `secrets.tdb` file.

16.5 NT4-Style Domain Trusts with Windows 2000

Although Domain User Manager is not present in Windows 2000, it is also possible to establish an NT4-style trust relationship with a Windows 2000 domain controller running in mixed mode as the trusting server. It should also be possible for Samba to trust a Windows 2000 server, however, more testing is still needed in this area.

After creating the interdomain trust account on the Samba server as described above, open Active Directory Domains and Trusts on the AD controller of the domain whose resources you wish Samba users to have access to. Remember that since NT4-style trusts are not transitive, if you want your users to have access to multiple mixed-mode domains in your AD forest, you will need to repeat this process for each of those domains. With Active Directory Domains and Trusts open, right-click on the name of the Active Directory domain that will trust our Samba domain and choose **Properties**, then click on the **Trusts** tab. In the upper part of the panel, you will see a list box labeled **Domains trusted by this domain:**, and an **Add...** button next to it. Press this button and just as with NT4, you will be prompted for the trusted domain name and the relationship password. Press OK and after a moment, Active Directory will respond with **The trusted domain has been added and the trust has been verified**. Your Samba users can now be granted access to resources in the AD domain.

16.6 Common Errors

Interdomain trust relationships should not be attempted on networks that are unstable or that suffer regular outages. Network stability and integrity are key concerns with distributed trusted domains.

16.6.1 Browsing of Trusted Domain Fails

Browsing from a machine in a trusted Windows 200x Domain to a Windows 200x member of a trusting samba domain, I get the following error:

. The system detected a possible attempt to compromise security. Please ensure that you can contact the server that authenticated you.

The event logs on the box I'm trying to connect to have entries regarding group policy not being applied because it is a member of a down-level domain.

Answer: If there is a computer account in the Windows 200x Domain for the machine in question, and it is disabled, this problem can occur. If there is no computer account (removed or never existed), or if that account is still intact (i.e.: you just joined it to another domain) everything seems to be fine. By default, when you un-join a domain (the Windows 200x Domain), the computer tries to automatically disable the computer account in the domain. If you are running as an account which has privileges to do this when you un-join the machine, it is done, otherwise it is not done.

16.6.2 Problems With LDAP Idapsam And The smbldap-tools

If you use the `smbldap-useradd.pl` script to create a trust account to set up Interdomain trusts the process of setting up the trust will fail. The account that was created in the LDAP database will have an account flags field that has [W], when it must have [I] for Interdomain trusts to work.

*Answer:*Here is a simple solution. Create a machine account as follows:

```
root# smbldap-useradd.pl -w domain_name
```

Then set the desired trust account password as shown here:

```
root# smbldap-passwd.pl domain_name\$
```

Using a text editor, create the following file:

```
dn: uid=domain_name$,ou=People,dc={your-domain},dc={your-top-level-domain}
changetype: modify
sambaAcctFlags: [I          ]
```

Then apply the text file to the LDAP database as follows:

```
root# ldapmodify -x -h localhost \
-D "cn=Manager,dc={your-domain},dc={your-top-level-domain}" \
-W -f /path-to/foobar
```

Create a single-sided trust under the NT4 Domain User Manager, then execute:

```
root# net rpc trustdom establish domain_name
```

It works with Samba-3 and NT4 Domains, and also with Samba-3 and Windows 200x ADS in mixed mode. Both DC's, samba and NT, must have the same WINS server otherwise the trust will never work.

HOSTING A MICROSOFT DISTRIBUTED FILE SYSTEM TREE

17.1 Features and Benefits

The Distributed File System (DFS) provides a means of separating the logical view of files and directories that users see from the actual physical locations of these resources on the network. It allows for higher availability, smoother storage expansion, load balancing, and so on.

For information about DFS, refer to the Microsoft documentation <<http://www.microsoft.com/NTServer/nts/downloads/winfeatures/NTSDistrFile/AdminGuide.asp>>. This document explains how to host a DFS tree on a UNIX machine (for DFS-aware clients to browse) using Samba.

A Samba server can be made a DFS server by setting the global Boolean `host msdfs` parameter in the `smb.conf` file. You designate a share as a DFS root using the Share Level Boolean `msdfs root` parameter. A DFS root directory on Samba hosts DFS links in the form of symbolic links that point to other servers. For example, a symbolic link `junction->msdfs:storage1\share1` in the share directory acts as the DFS junction. When DFS-aware clients attempt to access the junction link, they are redirected to the storage location (in this case, `\\storage1\share1`).

DFS trees on Samba work with all DFS-aware clients ranging from Windows 95 to 200x. Following sample configuration shows how to setup a DFS tree on a Samba server. In the `/export/dfsroot` directory, you set up your DFS links to other servers on the network.

```
root# cd /export/dfsroot
root# chown root /export/dfsroot
root# chmod 755 /export/dfsroot
root# ln -s msdfs:storageA\shareA linka
root# ln -s msdfs:serverB\share,serverC\share linkb
```

Example 17.1.1. smb.conf with DFS configured

```
[global]
    netbios name = GANDALF
    host msdfs = yes

[dfs]
    path = /export/dfsroot
    msdfs root = yes
```

You should set up the permissions and ownership of the directory acting as the DFS root so that only designated users can create, delete or modify the msdfs links. Also note that symlink names should be all lowercase. This limitation exists to have Samba avoid trying all the case combinations to get at the link name. Finally, set up the symbolic links to point to the network shares you want and start Samba.

Users on DFS-aware clients can now browse the DFS tree on the Samba server at `\\samba\dfs`. Accessing links `linka` or `linkb` (which appear as directories to the client) takes users directly to the appropriate shares on the network.

17.2 Common Errors

- Windows clients need to be rebooted if a previously mounted non-DFS share is made a DFS root or vice versa. A better way is to introduce a new share and make it the DFS root.
- Currently, there's a restriction that msdfs symlink names should all be lowercase.
- For security purposes, the directory acting as the root of the DFS tree should have ownership and permissions set so only designated users can modify the symbolic links in the directory.

17.2.1 MSDFS UNIX Path Is Case-Critical

A network administrator sent advice to the Samba mailing list after a long sessions trying to determine why DFS was not working. His advice is worth noting.

“I spent some time trying to figure out why my particular dfs root wasn't working. I noted in the documentation that the symlink should be in all lowercase. It should be amended that the entire path to the symlink should all be in lowercase as well.”

For example, I had a share defined as such:

```
[pub]
    path = /export/home/Shares/public_share
    msdfs root = yes
```

and I could not make my Windows 9x/Me (with the dfs client installed) follow this symlink:

```
damage1 -> msdfs:damage\test-share
```

Running a debug level of 10 reveals:

```
[2003/08/20 11:40:33, 5] msdfs/msdfs.c:is_msdfs_link(176)
  is_msdfs_link: /export/home/shares/public_share/* does not exist.
```

Curious. So I changed the directory name from .../Shares/... to .../shares/... (along with my service definition) and it worked!

CLASSICAL PRINTING SUPPORT

18.1 Features and Benefits

Printing is often a mission-critical service for the users. Samba can provide this service reliably and seamlessly for a client network consisting of Windows workstations.

A Samba print service may be run on a Stand-alone or Domain Member server, side by side with file serving functions, or on a dedicated print server. It can be made as tight or as loosely secured as needs dictate. Configurations may be simple or complex. Available authentication schemes are essentially the same as described for file services in previous chapters. Overall, Samba's printing support is now able to replace an NT or Windows 2000 print server full-square, with additional benefits in many cases. Clients may download and install drivers and printers through their familiar "*Point'n'Print*" mechanism. Printer installations executed by "*Logon Scripts*" are no problem. Administrators can upload and manage drivers to be used by clients through the familiar "*Add Printer Wizard*". As an additional benefit, driver and printer management may be run from the command line or through scripts, making it more efficient in case of large numbers of printers. If a central accounting of print jobs (tracking every single page and supplying the raw data for all sorts of statistical reports) is required, this function is best supported by the newer Common UNIX Printing System (CUPS) as the print subsystem underneath the Samba hood.

This chapter deals with the foundations of Samba printing as they are implemented by the more traditional UNIX (BSD- and System V-style) printing systems. Many things covered in this chapter apply also to CUPS. If you use CUPS, you may be tempted to jump to the next chapter but you will certainly miss a few things if you do. It is recommended that you read this chapter as well as CUPS Printing Support.

NOTE



Most of the following examples have been verified on Windows XP Professional clients. Where this document describes the responses to commands given, bear in mind that Windows 200x/XP clients are quite similar, but may differ in minor details. Windows NT is somewhat different again.

18.2 Technical Introduction

Samba's printing support always relies on the installed print subsystem of the UNIX OS it runs on. Samba is a “*middleman*.” It takes print files from Windows (or other SMB) clients and passes them to the real printing system for further processing, therefore, it needs to communicate with both sides: the Windows print clients and the UNIX printing system. Hence, we must differentiate between the various client OS types, each of which behave differently, as well as the various UNIX print subsystems, which themselves have different features and are accessed differently.

This deals with the traditional way of UNIX printing. The next chapter covers in great detail the more modern *Common UNIX Printing System* (CUPS).

IMPORTANT

CUPS users, be warned: do not just jump on to the next chapter. You might miss important information only found here!

It is apparent from postings on the Samba mailing list that print configuration is one of the most problematic aspects of Samba administration today. Many new Samba administrators have the impression that Samba performs some sort of print processing. Rest assured, Samba does not perform any type of print processing. It does not do any form of print filtering.

Samba obtains from its clients a data stream (print job) that it spools to a local spool area. When the entire print job has been received, Samba invokes a local UNIX/Linux print command and passes the spooled file to it. It is up to the local system printing subsystems to correctly process the print job and to submit it to the printer.

18.2.1 Client to Samba Print Job Processing

Successful printing from a Windows client via a Samba print server to a UNIX printer involves six (potentially seven) stages:

1. Windows opens a connection to the printer share.
2. Samba must authenticate the user.
3. Windows sends a copy of the print file over the network into Samba's spooling area.
4. Windows closes the connection.
5. Samba invokes the print command to hand the file over to the UNIX print subsystem's spooling area.
6. The UNIX print subsystem processes the print job.
7. The print file may need to be explicitly deleted from the Samba spooling area. This item depends on your print spooler configuration settings.

18.2.2 Printing Related Configuration Parameters

There are a number of configuration parameters to control Samba's printing behavior. Please refer to the man page for `smb.conf` for an overview of these. As with other parameters, there are Global Level (tagged with a *G* in the listings) and Service Level (*S*) parameters.

Global Parameters These *may not* go into individual share definitions. If they go in by error, the `testparm` utility can discover this (if you run it) and tell you so.

Service Level Parameters These may be specified in the `[global]` section of `smb.conf`. In this case they define the default behavior of all individual or service level shares (provided they do not have a different setting defined for the same parameter, thus overriding the global default).

18.3 Simple Print Configuration

Following example shows a simple printing configuration. If you compare this with your own, you may find additional parameters that have been pre-configured by your OS vendor. Below is a discussion and explanation of the parameters. This example does not use many parameters. However, in many environments these are enough to provide a valid `smb.conf` file that enables all clients to print.

This is only an example configuration. Samba assigns default values to all configuration parameters. The defaults are conservative and sensible. When a parameter is specified in the `smb.conf` file, this overwrites the default value. The `testparm` utility when run as root is capable of reporting all setting, both default as well as `smb.conf` file settings. `Testparm` gives warnings for all mis-configured settings. The complete output is easily 340 lines and more, so you may want to pipe it through a pager program.

The syntax for the configuration file is easy to grasp. You should know that is not very picky about its syntax. As has been explained elsewhere in this document, Samba tolerates some spelling errors (such as `browseable` instead of `Browseable`), and spelling is case-insensitive. It is permissible to use `Yes/No` or `True/False` for Boolean settings. Lists of names may be separated by commas, spaces or tabs.

Example 18.3.1. Simple configuration with BSD printing

```
[global]
    printing = bsd
    load printers = yes

[printers]
    path = /var/spool/samba
    printable = yes
    public = yes
    writable = no
```

18.3.1 Verifying Configuration with testparm

To see all (or at least most) printing-related settings in Samba, including the implicitly used ones, try the command outlined below. This command greps for all occurrences of `lp`, `print`, `spool`, `driver`, `ports` and `[` in testparms output. This provides a convenient overview of the running `smbd` print configuration. This command does not show individually created printer shares or the spooling paths they may use. Here is the output of my Samba setup, with settings shown in the example above:

```
root# testparm -s -v | egrep "(lp|print|spool|driver|ports|\[)"
Load smb config files from /etc/samba/smb.conf
Processing section "[homes]"
Processing section "[printers]"

[global]
    smb ports = 445 139
    lpq cache time = 10
    load printers = Yes
    printcap name = /etc/printcap
    disable spoolss = No
    enumports command =
    addprinter command =
    deleteprinter command =
    show add printer wizard = Yes
    os2 driver map =
    printer admin =
    min print space = 0
    max print jobs = 1000
    printable = No
    printing = bsd
    print command = lpr -r -P'%p' %s
    lpq command = lpq -P'%p'
    lprm command = lprm -P'%p' %j
    lppause command =
```

```
lpresume command =
printer name =
use client driver = No
```

```
[homes]
```

```
[printers]
```

```
path = /var/spool/samba
printable = Yes
```

You can easily verify which settings were implicitly added by Samba's default behavior. *Remember: it may be important in your future dealings with Samba.*

NOTE



testparm in Samba-3 behaves differently from that in 2.2.x: used without the “-v” switch it only shows you the settings actually written into! To see the complete configuration used, add the “-v” parameter to testparm.

18.3.2 Rapid Configuration Validation

Should you need to troubleshoot at any stage, please always come back to this point first and verify if **testparm** shows the parameters you expect. To give you a warning from personal experience, try to just comment out the load printers parameter. If your 2.2.x system behaves like mine, you'll see this:

```
root# grep "load printers" /etc/samba/smb.conf
# load printers = Yes
# This setting is commented out!!
```

```
root# testparm -v /etc/samba/smb.conf | egrep "(load printers)"
load printers = Yes
```

I assumed that commenting out of this setting should prevent Samba from publishing my printers, but it still did. It took some time to figure out the reason. But I am no longer fooled ... at least not by this.

```
root# grep -A1 "load printers" /etc/samba/smb.conf
load printers = No
# The above setting is what I want!
# load printers = Yes
```

```
# This setting is commented out!
```

```
root# testparm -s -v smb.conf.simpleprinting | egrep "(load printers)"
load printers = No
```

Only when the parameter is explicitly set to load printers = No would Samba conform with my intentions. So, my strong advice is:

- Never rely on commented out parameters.
- Always set parameters explicitly as you intend them to behave.
- Use **testparm** to uncover hidden settings that might not reflect your intentions.

The following is the most minimal configuration file:

```
root# cat /etc/samba/smb.conf-minimal
[printers]
```

This example should show that you can use testparm to test any Samba configuration file. Actually, we encourage you *not* to change your working system (unless you know exactly what you are doing). Don't rely on the assumption that changes will only take effect after you re-start smbd! This is not the case. Samba re-reads it every 60 seconds and on each new client connection. You might have to face changes for your production clients that you didn't intend to apply. You will now note a few more interesting things; **testparm** is useful to identify what the Samba print configuration would be if you used this minimalistic configuration. Here is what you can expect to find:

```
root# testparm -v smb.conf-minimal | egrep "(print|lpq|spool|driver|ports|[])"
Processing section "[printers]"
WARNING: [printers] service MUST be printable!
No path in service printers - using /tmp

lpq cache time = 10
load printers = Yes
printcap name = /etc/printcap
disable spoolss = No
enumports command =
addprinter command =
deleteprinter command =
show add printer wizard = Yes
os2 driver map =
printer admin =
min print space = 0
max print jobs = 1000
printable = No
printing = bsd
```

```

print command = lpr -r -P%p %s
lpq command = lpq -P%p
printer name =
use client driver = No

```

```

[printers]
    printable = Yes

```

testparm issued two warnings:

- We did not specify the *[printers]* section as printable.
- We did not tell Samba which spool directory to use.

However, this was not fatal and Samba will default to values that will work. Please, do not rely on this and do not use this example. This was included to encourage you to be careful to design and specify your setup to do precisely what you require. The outcome on your system may vary for some parameters given, since Samba may have been built with different compile-time options. *Warning:* do not put a comment sign *at the end* of a valid line. It will cause the parameter to be ignored (just as if you had put the comment sign at the front). At first I regarded this as a bug in my Samba versions. But the man page clearly says: “*Internal whitespace in a parameter value is retained verbatim.*” This means that a line consisting of, for example:

```

# This defines LPRng as the printing system
    printing = lprng

```

will regard the whole of the string after the “=” sign as the value you want to define. This is an invalid value that will be ignored and a default value will be used in its place.

18.4 Extended Printing Configuration

Next configuration shows a more verbose example configuration for print-related settings in a BSD-style printing environment. What follows is a discussion and explanation of the various parameters. We chose to use BSD-style printing here because it is still the most commonly used system on legacy UNIX/Linux installations. New installations predominantly use CUPS, which is discussed in a separate chapter. The example explicitly names many parameters that do not need to be specified because they are set by default. You could use a much leaner `smb.conf` file. Alternately, you can use **testparm** or **SWAT** to optimize the `smb.conf` file to remove all parameters that are set at default.

This is an example configuration. You may not find all the settings that are in the configuration file that was provided by the OS vendor. Samba configuration parameters, if not explicitly set default to a sensible value. To see all settings, as **root** use the **testparm** utility. **testparm** gives warnings for mis-configured settings.

Example 18.4.1. Extended BSD Printing Configuration

```
[global]
    printing = bsd
    load printers = yes
    show add printer wizard = yes
    printcap name = /etc/printcap
    printer admin = @ntadmin, root
    max print jobs = 100
    lpq cache time = 20
    use client driver = no

[printers]
    comment = All Printers
    printable = yes
    path = /var/spool/samba
    browseable = no
    guest ok = yes
    public = yes
    read only = yes
    writable = no

[my_printer_name]
    comment = Printer with Restricted Access
    path = /var/spool/samba_my_printer
    printer admin = kurt
    browseable = yes
    printable = yes
    writable = no
    hosts allow = 0.0.0.0
    hosts deny = turbo_xp, 10.160.50.23, 10.160.51.60
    guest ok = no
```

18.4.1 Detailed Explanation Settings

The following is a discussion of the settings from above shown example.

18.4.1.1 The [global] Section

The *[global]* section is one of four special sections (along with *[homes]*, *[printers]* and *[print\$]...*). The *[global]* contains all parameters which apply to the server as a whole. It is the place for parameters that have only a global meaning. It may also contain service level parameters that then define default settings for all other sections and shares. This way you can simplify the configuration and avoid setting the same value repeatedly. (Within each individual section or share you may, however, override these globally set share settings and specify other values).

printing = bsd Causes Samba to use default print commands applicable for the BSD (also known as RFC 1179 style or LPR/LPD) printing system. In general, the *printing* parameter informs Samba about the print subsystem it should expect. Samba supports CUPS, LPD, LPRNG, SYSV, HPUX, AIX, QNX, and PLP. Each of these systems defaults to a different print command (and other queue control commands).

CAUTION

The *printing* parameter is normally a service level parameter. Since it is included here in the *[global]* section, it will take effect for all printer shares that are not defined differently. Samba-3 no longer supports the SOFTQ printing system.

load printers = yes Tells Samba to create automatically all available printer shares. Available printer shares are discovered by scanning the printcap file. All created printer shares are also loaded for browsing. If you use this parameter, you do not need to specify separate shares for each printer. Each automatically created printer share will clone the configuration options found in the *[printers]* section. (The *load printers = no* setting will allow you to specify each UNIX printer you want to share separately, leaving out some you do not want to be publicly visible and available).

show add printer wizard = yes Setting is normally enabled by default (even if the parameter is not specified in *smb.conf*). It causes the **Add Printer Wizard** icon to appear in the **Printers** folder of the Samba host's share listing (as shown in **Network Neighborhood** or by the **net view** command). To disable it, you need to explicitly set it to *no* (commenting it out will not suffice). The *Add Printer Wizard* lets you upload printer drivers to the *[print\$]* share and associate it with a printer (if the respective queue exists before the action), or exchange a printer's driver against any other previously uploaded driver.

max print jobs = 100 Sets the upper limit to 100 print jobs being active on the Samba server at any one time. Should a client submit a job that exceeds this number, a "*no more space available on server*" type of error message will be returned by Samba to the client. A setting of zero (the default) means there is *no* limit at all.

printcap name = /etc/printcap Tells Samba where to look for a list of available printer names. Where CUPS is used, make sure that a printcap file is written. This is controlled by the **Printcap** directive in the *cupsd.conf* file.

printer admin = @ntadmin Members of the *ntadmin* group should be able to add drivers and set printer properties (*ntadmin* is only an example name, it needs to be a valid

UNIX group name); root is implicitly always a printer admin. The @ sign precedes group names in the `/etc/group`. A printer admin can do anything to printers via the remote administration interfaces offered by MS-RPC (see below). In larger installations, the printer admin parameter is normally a per-share parameter. This permits different groups to administer each printer share.

lpq cache time = 20 Controls the cache time for the results of the `lpq` command. It prevents the `lpq` command being called too often and reduces the load on a heavily used print server.

use client driver = no If set to `yes`, only takes effect for Windows NT/200x/XP clients (and not for Win 95/98/ME). Its default value is `No` (or `False`). It must *not* be enabled on print shares (with a `yes` or `true` setting) that have valid drivers installed on the Samba server. For more detailed explanations see the `smb.conf` man page.

18.4.1.2 The `[printers]` Section

This is the second special section. If a section with this name appears in the `smb.conf`, users are able to connect to any printer specified in the Samba host's `printcap` file, because Samba on startup then creates a printer share for every printer name it finds in the `printcap` file. You could regard this section as a general convenience shortcut to share all printers with minimal configuration. It is also a container for settings that should apply as default to all printers. (For more details see the `smb.conf` man page.) Settings inside this container must be Share Level parameters.

comment = All printers The comment is shown next to the share if a client queries the server, either via **Network Neighborhood** or with the **net view** command to list available shares.

printable = yes The `[printers]` service *must* be declared as printable. If you specify otherwise, `smbd` will refuse to load at startup. This parameter allows connected clients to open, write to and submit spool files into the directory specified with the `path` parameter for this service. It is used by Samba to differentiate printer shares from file shares.

path = /var/spool/samba Must point to a directory used by Samba to spool incoming print files. *It must not be the same as the spool directory specified in the configuration of your UNIX print subsystem!* The path typically points to a directory that is world writable, with the “*sticky*” bit set to it.

browseable = no Is always set to `no` if `printable = yes`. It makes the `[printer]` share itself invisible in the list of available shares in a **net view** command or in the Explorer browse list. (You will of course see the individual printers).

guest ok = yes If this parameter is set to **yes**, no password is required to connect to the printer's service. Access will be granted with the privileges of the guest account. On many systems the guest account will map to a user named "*nobody*". This user will usually be found in the UNIX `passwd` file with an empty password, but with no valid UNIX login. (On some systems the guest account might not have the privilege to be able to print. Test this by logging in as your guest user using `su - guest` and run a system print command like:

```
lpr -P printername /etc/motd
```

public = yes Is a synonym for `guest ok = yes`. Since we have `guest ok = yes`, it really does not need to be here. (This leads to the interesting question: "*What if I by accident have two contradictory settings for the same share?*" The answer is the last one encountered by Samba wins. Testparm does not complain about different settings of the same parameter for the same share. You can test this by setting up multiple lines for the `guest account` parameter with different usernames, and then run testparm to see which one is actually used by Samba.)

read only = yes Normally (for other types of shares) prevents users from creating or modifying files in the service's directory. However, in a "*printable*" service, it is *always* allowed to write to the directory (if user privileges allow the connection), but only via print spooling operations. Normal write operations are not permitted.

writable = no Is a synonym for `read only = yes`.

18.4.1.3 Any [my_printer_name] Section

If a section appears in the `smb.conf` file, which when given the parameter `printable = yes` causes Samba to configure it as a printer share. Windows 9x/Me clients may have problems with connecting or loading printer drivers if the share name has more than eight characters. Do not name a printer share with a name that may conflict with an existing user or file share name. On Client connection requests, Samba always tries to find file shares with that name first. If it finds one, it will connect to this and will not connect to a printer with the same name!

comment = Printer with Restricted Access The comment says it all.

path = /var/spool/samba_my_printer Sets the spooling area for this printer to a directory other than the default. It is not necessary to set it differently, but the option is available.

printer admin = kurt The printer admin definition is different for this explicitly defined printer share from the general [*printers*] share. It is not a requirement; we did it to show that it is possible.

browseable = yes This makes the printer browseable so the clients may conveniently find it when browsing the **Network Neighborhood**.

printable = yes See The [printers] Section.

writable = no See The [printers] Section.

hosts allow = 10.160.50.,10.160.51. Here we exercise a certain degree of access control by using the `hosts allow` and `hosts deny` parameters. This is not by any means a safe bet. It is not a way to secure your printers. This line accepts all clients from a certain subnet in a first evaluation of access control.

hosts deny = turbo_xp,10.160.50.23,10.160.51.60 All listed hosts are not allowed here (even if they belong to the allowed subnets). As you can see, you could name IP addresses as well as NetBIOS hostnames here.

guest ok = no This printer is not open for the guest account.

18.4.1.4 Print Commands

In each section defining a printer (or in the *[printers]* section), a *print command* parameter may be defined. It sets a command to process the files that have been placed into the Samba print spool directory for that printer. (That spool directory was, if you remember, set up with the `path` parameter). Typically, this command will submit the spool file to the Samba host's print subsystem, using the suitable system print command. But there is no requirement that this needs to be the case. For debugging or some other reason, you may want to do something completely different than print the file. An example is a command that just copies the print file to a temporary location for further investigation when you need to debug printing. If you craft your own print commands (or even develop print command shell scripts), make sure you pay attention to the need to remove the files from the Samba spool directory. Otherwise, your hard disk may soon suffer from shortage of free space.

18.4.1.5 Default UNIX System Printing Commands

You learned earlier on that Samba, in most cases, uses its built-in settings for many parameters if it cannot find an explicitly stated one in its configuration file. The same is true for the print command. The default print command varies depending on the printing parameter setting. In the commands listed below, you will notice some parameters of the form `%X` where `X` is `p`, `s`, `J`, and so on. These letters stand for printer name, spool-file and job ID, respectively. They are explained in more detail further below. Next table presents an overview of key printing options but excludes the special case of CUPS that is discussed in CUPS Printing Support.

Table 18.1. Default Printing Settings

Setting	Default Printing Commands
printing = bsd aix lprng plp	print command is lpr -r -P%p %s
printing = sysv hpux	print command is lp -c -P%p %s; rm %s
printing = qnx	print command is lp -r -P%p -s %s
printing = bsd aix lprng plp	lpq command is lpq -P%p
printing = sysv hpux	lpq command is lpstat -o%p
printing = qnx	lpq command is lpq -P%p
printing = bsd aix lprng plp	lprm command is lprm -P%p %j
printing = sysv hpux	lprm command is cancel %p-%j
printing = qnx	lprm command is cancel %p-%j
printing = bsd aix lprng plp	lppause command is lp -i %p-%j -H hold
printing = sysv hpux	lppause command (...is empty)
printing = qnx	lppause command (...is empty)
printing = bsd aix lprng plp	lpresume command is lp -i %p-%j -H resume
printing = sysv hpux	lpresume command (...is empty)
printing = qnx	lpresume command (...is empty)

We excluded the special case of CUPS here, because it is discussed in the next chapter. For *printing = CUPS*, if Samba is compiled against libcups, it uses the CUPS API to submit jobs. (It is a good idea also to set `printcap = cups` in case your `cupsd.conf` is set to write its auto-generated `printcap` file to an unusual place). Otherwise, Samba maps to the System V printing commands with the `-oraw` option for printing, i.e., it uses **lp -c -d%p -oraw; rm %s**. With *printing = cups*, and if Samba is compiled against libcups, any manually set print command will be ignored!

18.4.1.6 Custom Print Commands

After a print job has finished spooling to a service, the print command will be used by Samba via a `system()` call to process the spool file. Usually the command specified will submit the spool file to the host's printing subsystem. But there is no requirement at all that this must be the case. The print subsystem may not remove the spool file on its own. So whatever command you specify, you should ensure that the spool file is deleted after it has been processed.

There is no difficulty with using your own customized print commands with the traditional printing systems. However, if you do not wish to roll your own, you should be well informed about the default built-in commands that Samba uses for each printing subsystem (see Table 17.1). In all the commands listed in the last paragraphs, you see parameters of the form `%X`. These are *macros*, or shortcuts, used as place-holders for the names of real objects. At the time of running a command with such a placeholder, Samba will insert the appropriate value automatically. Print commands can handle all Samba macro substitutions. In regard to printing, the following ones do have special relevance:

- `%s`, `%f` — the path to the spool file name.
- `%p` — the appropriate printer name.

- `%J` — the job name as transmitted by the client.
- `%c` — the number of printed pages of the spooled job (if known).
- `%z` — the size of the spooled print job (in bytes).

The print command must contain at least one occurrence of `%s` or the `%f`. The `%p` is optional. If no printer name is supplied, the `%p` will be silently removed from the print command. In this case, the job is sent to the default printer.

If specified in the `[global]` section, the print command given will be used for any printable service that does not have its own print command specified. If there is neither a specified print command for a printable service nor a global print command, spool files will be created but not processed! Most importantly, print files will not be removed, so they will consume disk space.

Printing may fail on some UNIX systems when using the “*nobody*” account. If this happens, create an alternative guest account and give it the privilege to print. Set up this guest account in the `[global]` section with the `guest account` parameter.

You can form quite complex print commands. You need to realize that print commands are just passed to a UNIX shell. The shell is able to expand the included environment variables as usual. (The syntax to include a UNIX environment variable `$variable` in the Samba print command is ``${variable}`.) To give you a working print command example, the following will log a print job to `/tmp/print.log`, print the file, then remove it. The semicolon (“;” is the usual separator for commands in shell scripts:

```
print command = echo Printing %s >> \
/tmp/print.log; lpr -P %p %s; rm %s
```

You may have to vary your own command considerably from this example depending on how you normally print files on your system. The default for the print command parameter varies depending on the setting of the printing parameter. Another example is:

```
print command = /usr/local/samba/bin/myprintscript %p %s
```

18.5 Printing Developments Since Samba-2.2

Prior to Samba-2.2.x, print server support for Windows clients was limited to *LanMan* printing calls. This is the same protocol level as Windows 9x/Me PCs offer when they share printers. Beginning with the 2.2.0 release, Samba started to support the native Windows NT printing mechanisms. These are implemented via *MS-RPC* (RPC = *Remote Procedure Calls*). MS-RPCs use the *SPOOLSS* named pipe for all printing.

The additional functionality provided by the new SPOOLSS support includes:

- Support for downloading printer driver files to Windows 95/98/NT/2000 clients upon demand (*Point'n'Print*).
- Uploading of printer drivers via the Windows NT *Add Printer Wizard* (APW) or the Imprints `<http://imprints.sourceforge.net/>` tool set.

- Support for the native MS-RPC printing calls such as `StartDocPrinter`, `EnumJobs()`, and so on. (See the MSDN documentation <<http://msdn.microsoft.com/>> for more information on the Win32 printing API).
- Support for NT *Access Control Lists* (ACL) on printer objects.
- Improved support for printer queue manipulation through the use of internal databases for spooled job information (implemented by various `*.tdb` files).

A benefit of updating is that Samba-3 is able to publish its printers to Active Directory (or LDAP).

A fundamental difference exists between MS Windows NT print servers and Samba operation. Windows NT permits the installation of local printers that are not shared. This is an artifact of the fact that any Windows NT machine (server or client) may be used by a user as a workstation. Samba will publish all printers that are made available, either by default or by specific declaration via printer-specific shares.

Windows NT/200x/XP Professional clients do not have to use the standard SMB printer share; they can print directly to any printer on another Windows NT host using MS-RPC. This, of course, assumes that the client has the necessary privileges on the remote host that serves the printer resource. The default permissions assigned by Windows NT to a printer gives the Print permissions to the well-known *Everyone* group. (The older clients of type Windows 9x/Me can only print to shared printers).

18.5.1 Point'n'Print Client Drivers on Samba Servers

There is much confusion about what all this means. The question is often asked, “*Is it or is it not necessary for printer drivers to be installed on a Samba host in order to support printing from Windows clients?*” The answer to this is no, it is not necessary.

Windows NT/2000 clients can, of course, also run their APW to install drivers *locally* (which then connect to a Samba-served print queue). This is the same method used by Windows 9x/Me clients. (However, a *bug* existed in Samba 2.2.0 that made Windows NT/2000 clients require that the Samba server possess a valid driver for the printer. This was fixed in Samba 2.2.1).

But it is a new capability to install the printer drivers into the `[print$]` share of the Samba server, and a big convenience, too. Then *all* clients (including 95/98/ME) get the driver installed when they first connect to this printer share. The *uploading* or *depositing* of the driver into this `[print$]` share and the following binding of this driver to an existing Samba printer share can be achieved by different means:

- Running the APW on an NT/200x/XP Professional client (this does not work from 95/98/ME clients).
- Using the *Imprints* tool-set.
- Using the *smbclient* and *rpcclient* command-line tools.
- Using *cupsaddsmb* (only works for the CUPS printing system, not for LPR/LPD, LPRng, and so on).

Samba does not use these uploaded drivers in any way to process spooled files. These drivers are utilized entirely by the clients who download and install them via the “*Point’n’Print*” mechanism supported by Samba. The clients use these drivers to generate print files in the format the printer (or the UNIX print system) requires. Print files received by Samba are handed over to the UNIX printing system, which is responsible for all further processing, as needed.

18.5.2 The Obsoleted `[printer$]` Section

Versions of Samba prior to 2.2 made it possible to use a share named `[printer$]`. This name was taken from the same named service created by Windows 9x/Me clients when a printer was shared by them. Windows 9x/Me printer servers always have a `[printer$]` service that provides read-only access (with no password required) to support printer driver downloads. However, Samba’s initial implementation allowed for a parameter named *printer driver location* to be used on a per share basis. This specified the location of the driver files associated with that printer. Another parameter named *printer driver* provided a means of defining the printer driver name to be sent to the client.

These parameters, including the *printer driver file* parameter, are now removed and cannot be used in installations of Samba-3. The share name `[print$]` is now used for the location of download-able printer drivers. It is taken from the `[print$]` service created by Windows NT PCs when a printer is shared by them. Windows NT print servers always have a `[print$]` service that provides read-write access (in the context of its ACLs) to support printer driver downloads and uploads. This does not mean Windows 9x/Me clients are now thrown aside. They can use Samba’s `[print$]` share support just fine.

18.5.3 Creating the `[print$]` Share

In order to support the uploading and downloading of printer driver files, you must first configure a file share named `[print$]`. The public name of this share is hard coded in the MS Windows clients. It cannot be renamed since Windows clients are programmed to search for a service of exactly this name if they want to retrieve printer driver files.

You should modify the server’s file to add the global parameters and create the `[print$]` file share (of course, some of the parameter values, such as path are arbitrary and should be replaced with appropriate values for your site). See next example.

Of course, you also need to ensure that the directory named by the path parameter exists on the UNIX file system.

18.5.4 `[print$]` Section Parameters

The `[print$]` is a special section in `smb.conf`. It contains settings relevant to potential printer driver download and is used by windows clients for local print driver installation. The following parameters are frequently needed in this share section:

Example 18.5.1. [print\]\$ example

```

[global]
# members of the ntadmin group should be able to add drivers and set
# printer properties. root is implicitly always a 'printer admin'.
    printer admin = @ntadmin
...

[printers]
...

[print$]
    comment = Printer Driver Download Area
    path = /etc/samba/drivers
    browseable = yes
    guest ok = yes
    read only = yes
    write list = @ntadmin, root

```

comment = Printer Driver Download Area The comment appears next to the share name if it is listed in a share list (usually Windows clients will not see it, but it will also appear up in a **smbclient -L sambaserver** output).

path = /etc/samba/printers Is the path to the location of the Windows driver file deposit from the UNIX point of view.

browseable = no Makes the *[print\$]* share invisible to clients from the **Network Neighborhood**. However, you can still mount it from any client using the **net use g:\\sambaserver\pri** command in a DOS-box or the **Connect network drive menu>** from Windows Explorer.

guest ok = yes Gives read-only access to this share for all guest users. Access may be granted to download and install printer drivers on clients. The requirement for *guest ok = yes* depends on how your site is configured. If users will be guaranteed to have an account on the Samba host, then this is a non-issue.

NOTE



If all your Windows NT users are guaranteed to be authenticated by the Samba server (for example, if Samba authenticates via an NT domain server and the user has already been validated by the Domain Controller in order to logon to the Windows NT session), then guest access is not necessary. Of course, in a workgroup environment where you just want to print without worrying about silly accounts and security, then configure the share for guest access. You should consider adding `map to guest = Bad User` in the `[global]` section as well. Make sure you understand what this parameter does before using it.

read only = yes Because we do not want everybody to upload driver files (or even change driver settings), we tagged this share as not writable.

write list = @ntadmin, root The `[print$]` was made read-only by the previous setting so we should create a `write list` entry also. UNIX groups (denoted with a leading “@” character). Users listed here are allowed write-access (as an exception to the general public’s read-only access), which they need to update files on the share. Normally, you will want to only name administrative-level user account in this setting. Check the file system permissions to make sure these accounts can copy files to the share. If this is a non-root account, then the account should also be mentioned in the global printer admin parameter. See the `smb.conf` man page for more information on configuring file shares.

18.5.5 The `[print$]` Share Directory

In order for a Windows NT print server to support the downloading of driver files by multiple client architectures, you must create several subdirectories within the `[print$]` service (i.e., the UNIX directory named by the path parameter). These correspond to each of the supported client architectures. Samba follows this model as well. Just like the name of the `[print$]` share itself, the subdirectories must be exactly the names listed below (you may leave out the subdirectories of architectures you do not need to support).

Therefore, create a directory tree below the `[print$]` share for each architecture you wish to support like this:

```
[print$]--+
|--W32X86      # serves drivers to Windows NT x86
|--WIN40       # serves drivers to Windows 95/98
|--W32ALPHA    # serves drivers to Windows NT Alpha_AXP
|--W32MIPS     # serves drivers to Windows NT R4000
|--W32PPC      # serves drivers to Windows NT PowerPC
```

REQUIRED PERMISSIONS

In order to add a new driver to your Samba host, one of two conditions must hold true:

- The account used to connect to the Samba host must have a UID of 0 (i.e., a root account).
- The account used to connect to the Samba host must be named in the *printer adminlist*.

Of course, the connected account must still have write access to add files to the subdirectories beneath `[print$]`. Remember that all file shares are set to “*read-only*” by default.

Once you have created the required `[print$]` service and associated subdirectories, go to a Windows NT 4.0/200x/XP client workstation. Open **Network Neighborhood** or **My Network Places** and browse for the Samba host. Once you have located the server, navigate to its **Printers and Faxes** folder. You should see an initial listing of printers that matches the printer shares defined on your Samba host.

18.6 Installing Drivers into `[print$]`

Have you successfully created the `[print$]` share in `smb.conf`, and have you forced Samba to re-read its `smb.conf` file? Good. But you are not yet ready to use the new facility. The client driver files need to be installed into this share. So far it is still an empty share. Unfortunately, it is not enough to just copy the driver files over. They need to be correctly installed so that appropriate records for each driver will exist in the Samba internal databases so it can provide the correct drivers as they are requested from MS Windows clients. And that is a bit tricky, to say the least. We now discuss two alternative ways to install the drivers into `[print$]`:

- Using the Samba command-line utility **rpcclient** with its various subcommands (here: **adddriver** and **setdriver**) from any UNIX workstation.
- Running a GUI (**Printer Properties** and **Add Printer Wizard**) from any Windows NT/200x/XP client workstation.

The latter option is probably the easier one (even if the process may seem a little bit weird at first).

18.6.1 Add Printer Wizard Driver Installation

The initial listing of printers in the Samba host’s **Printers** folder accessed from a client’s Explorer will have no real printer driver assigned to them. By default this driver name is

set to a null string. This must be changed now. The local **Add Printer Wizard** (APW), run from NT/2000/XP clients, will help us in this task.

Installation of a valid printer driver is not straightforward. You must attempt to view the printer properties for the printer to which you want the driver assigned. Open the Windows Explorer, open **Network Neighborhood**, browse to the Samba host, open Samba's **Printers** folder, right-click on the printer icon and select **Properties...** You are now trying to view printer and driver properties for a queue that has this default NULL driver assigned. This will result in the following error message:

Device settings cannot be displayed. The driver for the specified printer is not installed, only spooler properties will be displayed. Do you want to install the driver now?

Do not click on **Yes!** Instead, click on **No** in the error dialog. Only now you will be presented with the printer properties window. From here, the way to assign a driver to a printer is open to us. You now have the choice of:

- Select a driver from the pop-up list of installed drivers. Initially this list will be empty.
- Click on **New Driver** to install a new printer driver (which will start up the APW).

Once the APW is started, the procedure is exactly the same as the one you are familiar with in Windows (we assume here that you are familiar with the printer driver installations procedure on Windows NT). Make sure your connection is, in fact, setup as a user with printer admin privileges (if in doubt, use **smbstatus** to check for this). If you wish to install printer drivers for client operating systems other than Windows NT x86, you will need to use the **Sharing** tab of the printer properties dialog.

Assuming you have connected with an administrative (or root) account (as named by the printer admin parameter), you will also be able to modify other printer properties such as ACLs and default device settings using this dialog. For the default device settings, please consider the advice given further in Installing Print Drivers Using **rpcclient**.

18.6.2 Installing Print Drivers Using **rpcclient**

The second way to install printer drivers into *[print\$]* and set them up in a valid way is to do it from the UNIX command line. This involves four distinct steps:

1. Gather info about required driver files and collect the files.
2. Deposit the driver files into the *[print\$]* share's correct subdirectories (possibly by using **smbclient**).
3. Run the **rpcclient** command line utility once with the **adddriver** subcommand.
4. Run **rpcclient** a second time with the **setdriver** subcommand.

We provide detailed hints for each of these steps in the paragraphs that follow.

18.6.2.1 Identifying Driver Files

To find out about the driver files, you have two options. You could check the contents of the driver CDROM that came with your printer. Study the ***.inf** files located on the CDROM.

This may not be possible, since the *.inf file might be missing. Unfortunately, vendors have now started to use their own installation programs. These installations packages are often in some Windows platform archive format. Additionally, the files may be re-named during the installation process. This makes it extremely difficult to identify the driver files required.

Then you only have the second option. Install the driver locally on a Windows client and investigate which file names and paths it uses after they are installed. (You need to repeat this procedure for every client platform you want to support. We show it here for the W32X86 platform only, a name used by Microsoft for all Windows NT/200x/XP clients.)

A good method to recognize the driver files is to print the test page from the driver's **Properties** dialog (**General** tab). Then look at the list of driver files named on the printout. You'll need to recognize what Windows (and Samba) are calling the **Driver File**, **Data File**, **Config File**, **Help File** and (optionally) the **Dependent Driver Files** (this may vary slightly for Windows NT). You need to take a note of all file names for the next steps.

Another method to quickly test the driver filenames and related paths is provided by the **rpcclient** utility. Run it with **enumdrivers** or with the **getdriver** subcommand, each at the 3 info level. In the following example, *TURBO_XP* is the name of the Windows PC (in this case it was a Windows XP Professional laptop). I installed the driver locally to TURBO_XP, from a Samba server called KDE-BITSHOP. We could run an interactive **rpcclient** session; then we would get an **rpcclient />** prompt and would type the subcommands at this prompt. This is left as a good exercise to the reader. For now, we use **rpcclient** with the **-c** parameter to execute a single subcommand line and exit again. This is the method you would use if you want to create scripts to automate the procedure for a large number of printers and drivers. Note the different quotes used to overcome the different spaces in between words:

```
root# rpcclient -U'Danka%xxxx' -c \
    'getdriver "Heidelberg Digimaster 9110 (PS)" 3' TURBO_XP
cmd = getdriver "Heidelberg Digimaster 9110 (PS)" 3
```

[Windows NT x86]

Printer Driver Info 3:

```
Version: [2]
Driver Name: [Heidelberg Digimaster 9110 (PS)]
Architecture: [Windows NT x86]
Driver Path: [C:\WINNT\System32\spool\DRIVERS\W32X86\2\HDNIS01_de.DLL]
Datafile: [C:\WINNT\System32\spool\DRIVERS\W32X86\2\Hddm91c1_de.ppd]
Configfile: [C:\WINNT\System32\spool\DRIVERS\W32X86\2\HDNIS01U_de.DLL]
Helpfile: [C:\WINNT\System32\spool\DRIVERS\W32X86\2\HDNIS01U_de.HLP]

Dependentfiles: [C:\WINNT\System32\spool\DRIVERS\W32X86\2\Hddm91c1_de.DLL]
Dependentfiles: [C:\WINNT\System32\spool\DRIVERS\W32X86\2\Hddm91c1_de.INI]
Dependentfiles: [C:\WINNT\System32\spool\DRIVERS\W32X86\2\Hddm91c1_de.dat]
Dependentfiles: [C:\WINNT\System32\spool\DRIVERS\W32X86\2\Hddm91c1_de.cat]
Dependentfiles: [C:\WINNT\System32\spool\DRIVERS\W32X86\2\Hddm91c1_de.def]
Dependentfiles: [C:\WINNT\System32\spool\DRIVERS\W32X86\2\Hddm91c1_de.hre]
```

```

Dependentfiles: [C:\WINNT\System32\spool\DRIVERS\W32X86\2\Hddm91c1_de.vnd]
Dependentfiles: [C:\WINNT\System32\spool\DRIVERS\W32X86\2\Hddm91c1_de.hlp]
Dependentfiles: [C:\WINNT\System32\spool\DRIVERS\W32X86\2\HDNISO1Aux.dll]
Dependentfiles: [C:\WINNT\System32\spool\DRIVERS\W32X86\2\HDNISO1_de.NTF]

Monitorname: []
Defaultdatatype: []

```

You may notice that this driver has quite a large number of **Dependent files** (there are worse cases, however). Also, strangely, the **Driver File** is tagged here **Driver Path**. We do not yet have support for the so-called WIN40 architecture installed. This name is used by Microsoft for the Windows 9x/Me platforms. If we want to support these, we need to install the Windows 9x/Me driver files in addition to those for W32X86 (i.e., the Windows NT72000/XP clients) onto a Windows PC. This PC can also host the Windows 9x/Me drivers, even if it runs on Windows NT, 2000 or XP.

Since the *[print\$]* share is usually accessible through the **Network Neighborhood**, you can also use the UNC notation from Windows Explorer to poke at it. The Windows 9x/Me driver files will end up in subdirectory 0 of the WIN40 directory. The full path to access them will be \\WINDOWSHOST\print\$\WIN40\0\.

NOTE



More recent drivers on Windows 2000 and Windows XP are installed into the “3” subdirectory instead of the “2”. The version 2 of drivers, as used in Windows NT, were running in Kernel Mode. Windows 2000 changed this. While it still can use the Kernel Mode drivers (if this is enabled by the Admin), its native mode for printer drivers is User Mode execution. This requires drivers designed for this. These types of drivers install into the “3” subdirectory.

18.6.2.2 Obtaining Driver Files from Windows Client [print\$] Shares

Now we need to collect all the driver files we identified in our previous step. Where do we get them from? Well, why not retrieve them from the very PC and the same *[print\$]* share that we investigated in our last step to identify the files? We can use **smbclient** to do this. We will use the paths and names that were leaked to us by **getdriver**. The listing is edited to include line breaks for readability:

```

root# smbclient //TURBO_XP/print\$ -U'Danka%xxxx' \
  -c 'cd W32X86/2;mget HD*_de.* hd*ppd Hd*_de.* Hddm*dll HDN*Aux.DLL'

added interface ip=10.160.51.60 bcast=10.160.51.255 nmask=255.255.252.0

```

```

Got a positive name query response from 10.160.50.8 ( 10.160.50.8 )
Domain=[DEVELOPMENT] OS=[Windows 5.1] Server=[Windows 2000 LAN Manager]
Get file Hddm91c1_de.ABD? n
Get file Hddm91c1_de.def? y
getting file \W32X86\2\Hddm91c1_de.def of size 428 as Hddm91c1_de.def
Get file Hddm91c1_de.DLL? y
getting file \W32X86\2\Hddm91c1_de.DLL of size 876544 as Hddm91c1_de.DLL
[...]

```

After this command is complete, the files are in our current local directory. You probably have noticed that this time we passed several commands to the `-c` parameter, separated by semi-colons. This effects that all commands are executed in sequence on the remote Windows server before `smbclient` exits again.

Remember to repeat the procedure for the WIN40 architecture should you need to support Windows 9x/Me/XP clients. Remember too, the files for these architectures are in the WIN40/0/ subdirectory. Once this is complete, we can run `smbclient ... put` to store the collected files on the Samba server's [print\$] share.

18.6.2.3 Installing Driver Files into [print\$]

We are now going to locate the driver files into the [print\$] share. Remember, the UNIX path to this share has been defined previously in your words missing here. You also have created subdirectories for the different Windows client types you want to support. Supposing your [print\$] share maps to the UNIX path `/etc/samba/drivers/`, your driver files should now go here:

- For all Windows NT, 2000 and XP clients into `/etc/samba/drivers/W32X86/` but not (yet) into the 2 subdirectory.
- For all Windows 95, 98 and ME clients into `/etc/samba/drivers/WIN40/` but not (yet) into the 0 subdirectory.

We again use `smbclient` to transfer the driver files across the network. We specify the same files and paths as were leaked to us by running `getdriver` against the original *Windows* install. However, now we are going to store the files into a *Samba/UNIX* print server's [print\$] share.

```

root# smbclient //SAMBA-CUPS/print\$ -U'root%xxxx' -c \
'cd W32X86; put HDNIS01_de.DLL; \
put Hddm91c1_de.ppd; put HDNIS01U_de.DLL; \
put HDNIS01U_de.HLP; put Hddm91c1_de.DLL; \
put Hddm91c1_de.INI; put Hddm91c1KMMIn.DLL; \
put Hddm91c1_de.dat; put Hddm91c1_de.dat; \
put Hddm91c1_de.def; put Hddm91c1_de.hre; \
put Hddm91c1_de.vnd; put Hddm91c1_de.hlp; \
put Hddm91c1_de_reg.HLP; put HDNIS01Aux.dll; \
put HDNIS01_de.NTF'

```

```

added interface ip=10.160.51.60 bcast=10.160.51.255 nmask=255.255.252.0
Got a positive name query response from 10.160.51.162 ( 10.160.51.162 )
Domain=[CUPS-PRINT] OS=[UNIX] Server=[Samba 2.2.7a]
putting file HDNIS01_de.DLL as \W32X86\HDNIS01_de.DLL
putting file Hddm91c1_de.ppd as \W32X86\Hddm91c1_de.ppd
putting file HDNIS01U_de.DLL as \W32X86\HDNIS01U_de.DLL
putting file HDNIS01U_de.HLP as \W32X86\HDNIS01U_de.HLP
putting file Hddm91c1_de.DLL as \W32X86\Hddm91c1_de.DLL
putting file Hddm91c1_de.INI as \W32X86\Hddm91c1_de.INI
putting file Hddm91c1KMMIn.DLL as \W32X86\Hddm91c1KMMIn.DLL
putting file Hddm91c1_de.dat as \W32X86\Hddm91c1_de.dat
putting file Hddm91c1_de.dat as \W32X86\Hddm91c1_de.dat
putting file Hddm91c1_de.def as \W32X86\Hddm91c1_de.def
putting file Hddm91c1_de.hre as \W32X86\Hddm91c1_de.hre
putting file Hddm91c1_de.vnd as \W32X86\Hddm91c1_de.vnd
putting file Hddm91c1_de.hlp as \W32X86\Hddm91c1_de.hlp
putting file Hddm91c1_de_reg.HLP as \W32X86\Hddm91c1_de_reg.HLP
putting file HDNIS01Aux.dll as \W32X86\HDNIS01Aux.dll
putting file HDNIS01_de.NTF as \W32X86\HDNIS01_de.NTF

```

Whew — that was a lot of typing! Most drivers are a lot smaller — many only having three generic PostScript driver files plus one PPD. While we did retrieve the files from the 2 subdirectory of the W32X86 directory from the Windows box, we do not put them (for now) in this same subdirectory of the Samba box. This relocation will automatically be done by the **addrdriver** command, which we will run shortly (and do not forget to also put the files for the Windows 9x/Me architecture into the WIN40/ subdirectory should you need them).

18.6.2.4 smbclient to Confirm Driver Installation

For now we verify that our files are there. This can be done with **smbclient**, too (but, of course, you can log in via SSH also and do this through a standard UNIX shell access):

```

root# smbclient //SAMBA-CUPS/print\$ -U 'root%xxxx' \
  -c 'cd W32X86; pwd; dir; cd 2; pwd; dir'
added interface ip=10.160.51.60 bcast=10.160.51.255 nmask=255.255.252.0
Got a positive name query response from 10.160.51.162 ( 10.160.51.162 )
Domain=[CUPS-PRINT] OS=[UNIX] Server=[Samba 2.2.8a]

Current directory is \\SAMBA-CUPS\print$\W32X86\
.                D            0   Sun May  4 03:56:35 2003
..               D            0   Thu Apr 10 23:47:40 2003
2                D            0   Sun May  4 03:56:18 2003
HDNIS01Aux.dll   A       15356  Sun May  4 03:58:59 2003
Hddm91c1KMMIn.DLL A       46966  Sun May  4 03:58:59 2003
HDNIS01_de.DLL  A      434400  Sun May  4 03:58:59 2003

```

```

HDNIS01_de.NTF          A    790404  Sun May  4 03:56:35 2003
Hddm91c1_de.DLL        A    876544  Sun May  4 03:58:59 2003
Hddm91c1_de.INI        A      101  Sun May  4 03:58:59 2003
Hddm91c1_de.dat        A    5044  Sun May  4 03:58:59 2003
Hddm91c1_de.def        A     428  Sun May  4 03:58:59 2003
Hddm91c1_de.hlp        A   37699  Sun May  4 03:58:59 2003
Hddm91c1_de.hre        A   323584 Sun May  4 03:58:59 2003
Hddm91c1_de.ppd        A   26373  Sun May  4 03:58:59 2003
Hddm91c1_de.vnd        A   45056  Sun May  4 03:58:59 2003
HDNIS01U_de.DLL        A   165888 Sun May  4 03:58:59 2003
HDNIS01U_de.HLP        A    19770 Sun May  4 03:58:59 2003
Hddm91c1_de_reg.HLP    A   228417 Sun May  4 03:58:59 2003
40976 blocks of size 262144. 709 blocks available

```

Current directory is \\SAMBA-CUPS\print\$\W32X86\2\

```

.          D      0  Sun May  4 03:56:18 2003
..         D      0  Sun May  4 03:56:35 2003
ADOBEPS5.DLL      A   434400  Sat May  3 23:18:45 2003
laserjet4.ppd     A     9639  Thu Apr 24 01:05:32 2003
ADOBEPSU.DLL     A   109568  Sat May  3 23:18:45 2003
ADOBEPSU.HLP     A    18082  Sat May  3 23:18:45 2003
PDFcreator2.PPD  A    15746  Sun Apr 20 22:24:07 2003
40976 blocks of size 262144. 709 blocks available

```

Notice that there are already driver files present in the 2 subdirectory (probably from a previous installation). Once the files for the new driver are there too, you are still a few steps away from being able to use them on the clients. The only thing you could do now is to retrieve them from a client just like you retrieve ordinary files from a file share, by opening `print$` in Windows Explorer. But that wouldn't install them per Point'n'Print. The reason is: Samba does not yet know that these files are something special, namely *printer driver files* and it does not know to which print queue(s) these driver files belong.

18.6.2.5 Running rpcclient with adddriver

Next, you must tell Samba about the special category of the files you just uploaded into the `[print$]` share. This is done by the `adddriver` command. It will prompt Samba to register the driver files into its internal TDB database files. The following command and its output has been edited, again, for readability:

```

root# rpcclient -Uroot%xxxx -c 'adddriver "Windows NT x86" \
  "dm9110:HDNIS01_de.DLL: \
  Hddm91c1_de.ppd:HDNIS01U_de.DLL:HDNIS01U_de.HLP: \
  NULL:RAW:Hddm91c1_de.DLL,Hddm91c1_de.INI, \
  Hddm91c1_de.dat,Hddm91c1_de.def,Hddm91c1_de.hre, \
  Hddm91c1_de.vnd,Hddm91c1_de.hlp,Hddm91c1KMMIn.DLL, \
  HDNIS01Aux.dll,HDNIS01_de.NTF, \

```



```
Hddm91c1_de_reg.HLP' SAMBA-CUPS
```

```
cmd = adddriver "Windows NT x86" \
"dm9110:HDNIS01_de.DLL:Hddm91c1_de.ppd:HDNIS01U_de.DLL: \
HDNIS01U_de.HLP:NULL:RAW:Hddm91c1_de.DLL,Hddm91c1_de.INI, \
Hddm91c1_de.dat,Hddm91c1_de.def,Hddm91c1_de.hre, \
Hddm91c1_de.vnd,Hddm91c1_de.hlp,Hddm91c1KMMin.DLL, \
HDNIS01Aux.dll,HDNIS01_de.NTF,Hddm91c1_de_reg.HLP"
```

Printer Driver dm9110 successfully installed.

After this step, the driver should be recognized by Samba on the print server. You need to be very careful when typing the command. Don't exchange the order of the fields. Some changes would lead to an `NT_STATUS_UNSUCCESSFUL` error message. These become obvious. Other changes might install the driver files successfully, but render the driver unworkable. So take care! Hints about the syntax of the `adddriver` command are in the man page. The CUPS printing chapter provides a more detailed description, should you need it.

18.6.2.6 Checking adddriver Completion

One indication for Samba's recognition of the files as driver files is the `successfully installed` message. Another one is the fact that our files have been moved by the `adddriver` command into the 2 subdirectory. You can check this again with `smbclient`:

```
root# smbclient //SAMBA-CUPS/print\$ -Uroot%xx \
-c 'cd W32X86;dir;pwd;cd 2;dir;pwd'
added interface ip=10.160.51.162 bcast=10.160.51.255 nmask=255.255.252.0
Domain=[CUPS-PRINT] OS=[UNIX] Server=[Samba 2.2.7a]
```

```
Current directory is \\SAMBA-CUPS\print$\W32X86\
.                D            0  Sun May  4 04:32:48 2003
..               D            0  Thu Apr 10 23:47:40 2003
2                D            0  Sun May  4 04:32:48 2003
                40976 blocks of size 262144. 731 blocks available
```

```
Current directory is \\SAMBA-CUPS\print$\W32X86\2\
.                D            0  Sun May  4 04:32:48 2003
..               D            0  Sun May  4 04:32:48 2003
DigiMaster.PPD  A      148336  Thu Apr 24 01:07:00 2003
ADOBEPS5.DLL    A      434400  Sat May  3 23:18:45 2003
laserjet4.ppd   A         9639  Thu Apr 24 01:05:32 2003
ADOBEPSU.DLL   A      109568  Sat May  3 23:18:45 2003
ADOBEPSU.HLP   A       18082  Sat May  3 23:18:45 2003
PDFcreator2.PPD A       15746  Sun Apr 20 22:24:07 2003
HDNIS01Aux.dll A       15356  Sun May  4 04:32:18 2003
Hddm91c1KMMin.DLL A       46966  Sun May  4 04:32:18 2003
```

```

HDNIS01_de.DLL           A    434400  Sun May  4 04:32:18 2003
HDNIS01_de.NTF           A    790404  Sun May  4 04:32:18 2003
Hddm91c1_de.DLL         A    876544  Sun May  4 04:32:18 2003
Hddm91c1_de.INI         A      101  Sun May  4 04:32:18 2003
Hddm91c1_de.dat         A     5044  Sun May  4 04:32:18 2003
Hddm91c1_de.def         A     428   Sun May  4 04:32:18 2003
Hddm91c1_de.hlp         A    37699  Sun May  4 04:32:18 2003
Hddm91c1_de.hre         A   323584  Sun May  4 04:32:18 2003
Hddm91c1_de.ppd         A    26373  Sun May  4 04:32:18 2003
Hddm91c1_de.vnd         A    45056  Sun May  4 04:32:18 2003
HDNIS01U_de.DLL         A   165888  Sun May  4 04:32:18 2003
HDNIS01U_de.HLP         A    19770  Sun May  4 04:32:18 2003
Hddm91c1_de_reg.HLP     A    228417 Sun May  4 04:32:18 2003
40976 blocks of size 262144. 731 blocks available

```

Another verification is that the timestamp of the printing TDB files is now updated (and possibly their file size has increased).

18.6.2.7 Check Samba for Driver Recognition

Now the driver should be registered with Samba. We can easily verify this, and will do so in a moment. However, this driver is not yet associated with a particular printer. We may check the driver status of the files by at least three methods:

- From any Windows client browse Network Neighborhood, find the Samba host and open the Samba **Printers and Faxes** folder. Select any printer icon, right-click and select the printer **Properties**. Click the **Advanced** tab. Here is a field indicating the driver for that printer. A drop-down menu allows you to change that driver (be careful not to do this unwittingly). You can use this list to view all drivers known to Samba. Your new one should be among them. (Each type of client will only see his own architecture's list. If you do not have every driver installed for each platform, the list will differ if you look at it from Windows95/98/ME or Windows NT/2000/XP.)
- From a Windows 200x/XP client (not Windows NT) browse **Network Neighborhood**, search for the Samba server and open the server's **Printers** folder, right-click on the white background (with no printer highlighted). Select **Server Properties**. On the **Drivers** tab you will see the new driver listed. This view enables you to also inspect the list of files belonging to that driver (this does not work on Windows NT, but only on Windows 2000 and Windows XP; Windows NT does not provide the **Drivers** tab). An alternative and much quicker method for Windows 2000/XP to start this dialog is by typing into a DOS box (you must of course adapt the name to your Samba server instead of *SAMBA-CUPS*):

```
rundll32 printui.dll,PrintUIEntry /s /t2 /n\\SAMBA-CUPS
```

- From a UNIX prompt, run this command (or a variant thereof) where *SAMBA-CUPS* is the name of the Samba host and *xxxx* represents the actual Samba password assigned to root:

```
rpcclient -U'root%xxxx' -c 'enumdrivers' SAMBA-CUPS
```

You will see a listing of all drivers Samba knows about. Your new one should be among them. But it is only listed under the *[Windows NT x86]* heading, not under *[Windows 4.0]*, since you didn't install that part. Or did you? You will see a listing of all drivers Samba knows about. Your new one should be among them. In our example it is named `dm9110`. Note that the third column shows the other installed drivers twice, one time for each supported architecture. Our new driver only shows up for Windows NT 4.0 or 2000. To have it present for Windows 95, 98 and ME, you'll have to repeat the whole procedure with the WIN40 architecture and subdirectory.

18.6.2.8 Specific Driver Name Flexibility

You can name the driver as you like. If you repeat the **adddriver** step with the same files as before but with a different driver name, it will work the same:

```
root# rpcclient -Uroot%xxxx \
-c 'adddriver "Windows NT x86" \
"mydrivername:HDNIS01_de.DLL: \
Hddm91c1_de.ppd:HDNIS01U_de.DLL:HDNIS01U_de.HLP: \
NULL:RAW:Hddm91c1_de.DLL,Hddm91c1_de.INI, \
Hddm91c1_de.dat,Hddm91c1_de.def,Hddm91c1_de.hre, \
Hddm91c1_de.vnd,Hddm91c1_de.hlp,Hddm91c1KMMin.DLL, \
HDNIS01Aux.dll,HDNIS01_de.NTF,Hddm91c1_de_reg.HLP' SAMBA-CUPS
```

```
cmd = adddriver "Windows NT x86" \
"mydrivername:HDNIS01_de.DLL:Hddm91c1_de.ppd:HDNIS01U_de.DLL:\
HDNIS01U_de.HLP:NULL:RAW:Hddm91c1_de.DLL,Hddm91c1_de.INI, \
Hddm91c1_de.dat,Hddm91c1_de.def,Hddm91c1_de.hre, \
Hddm91c1_de.vnd,Hddm91c1_de.hlp,Hddm91c1KMMin.DLL, \
HDNIS01Aux.dll,HDNIS01_de.NTF,Hddm91c1_de_reg.HLP"
```

Printer Driver mydrivername successfully installed.

You will be able to bind that driver to any print queue (however, you are responsible that you associate drivers to queues that make sense with respect to target printers). You cannot run the **rpcclient adddriver** command repeatedly. Each run consumes the files you had put into the *[print\$]* share by moving them into the respective subdirectories. So you must execute an **smbclient ... put** command before each **rpcclient ... adddriver** command.

18.6.2.9 Running rpcclient with the setdriver

Samba needs to know which printer owns which driver. Create a mapping of the driver to a printer, and store this info in Samba's memory, the TDB files. The **rpcclient setdriver** command achieves exactly this:

```
root# rpcclient -U'root%xxxx' -c 'setdriver dm9110 mydrivername' SAMBA-CUPS
cmd = setdriver dm9110 mydrivername
```

Successfully set dm9110 to driver mydrivername.

Ah, no, I did not want to do that. Repeat, this time with the name I intended:

```
root# rpcclient -U'root%xxxx' -c 'setdriver dm9110 dm9110' SAMBA-CUPS
cmd = setdriver dm9110 dm9110
Successfully set dm9110 to driver dm9110.
```

The syntax of the command is:

```
rpcclient -U'root%sambapassword' -c 'setdriver printername \
drivername' SAMBA-Hostname.
```

Now we have done most of the work, but not all of it.

NOTE



The **setdriver** command will only succeed if the printer is already known to Samba. A bug in 2.2.x prevented Samba from recognizing freshly installed printers. You had to restart Samba, or at least send an HUP signal to all running smbd processes to work around this: `kill -HUP `pidof smbd``.

18.7 Client Driver Installation Procedure

As Don Quixote said: “*The proof of the pudding is in the eating.*” The proof for our setup lies in the printing. So let’s install the printer driver onto the client PCs. This is not as straightforward as it may seem. Read on.

18.7.1 First Client Driver Installation

Especially important is the installation onto the first client PC (for each architectural platform separately). Once this is done correctly, all further clients are easy to setup and shouldn’t need further attention. What follows is a description for the recommended first procedure. You work now from a client workstation. You should guarantee that your connection is not unwittingly mapped to *bad user* nobody. In a DOS box type:

```
net use \\SAMBA-SERVER\print$ /user:root
```

Replace root, if needed, by another valid printer admin user as given in the definition. Should you already be connected as a different user, you will get an error message. There is no easy way to get rid of that connection, because Windows does not seem to know a concept of logging off from a share connection (do not confuse this with logging off from the local workstation; that is a different matter). On Windows NT/2K, you can force a logoff from all smb/cifs connections by restarting the “*workstation*” service. You can try to close all Windows file explorer and Internet Explorer for Windows. As a last resort, you may have to reboot. Make sure there is no automatic reconnection set up. It may be easier to go to a different workstation and try from there. After you have made sure you are connected as a printer admin user (you can check this with the `smbstatus` command on Samba), do this from the Windows workstation:

1. Open **Network Neighborhood**.
2. Browse to Samba server.
3. Open its **Printers and Faxes** folder.
4. Highlight and right-click on the printer.
5. Select **Connect** (for Windows NT4/200x it is possibly **Install**).

A new printer (named *printername* on Samba-server) should now have appeared in your *local* Printer folder (check **Start – Settings – Control Panel – Printers and Faxes**).

Most likely you are now tempted to try to print a test page. After all, you now can open the printer properties, and on the **General** tab there is a button offering to do just that. But chances are that you get an error message saying Unable to print Test Page. The reason might be that there is not yet a valid Device Mode set for the driver, or that the “*Printer Driver Data*” set is still incomplete.

You must make sure that a valid *Device Mode* is set for the driver. We now explain what that means.

18.7.2 Setting Device Modes on New Printers

For a printer to be truly usable by a Windows NT/200x/XP client, it must possess:

- A valid *Device Mode* generated by the driver for the printer (defining things like paper size, orientation and duplex settings).
- A complete set of *Printer Driver Data* generated by the driver.

If either of these is incomplete, the clients can produce less than optimal output at best. In the worst cases, unreadable garbage or nothing at all comes from the printer or it produces a harvest of error messages when attempting to print. Samba stores the named values and all printing related information in its internal TDB database files (`ntprinters.tdb`, `ntdrivers.tdb`, `printing.tdb` and `ntforms.tdb`).

What do these two words stand for? Basically, the Device Mode and the set of Printer Driver Data is a collection of settings for all print queue properties, initialized in a sensible way. Device Modes and Printer Driver Data should initially be set on the print server (the

Samba host) to healthy values so the clients can start to use them immediately. How do we set these initial healthy values? This can be achieved by accessing the drivers remotely from an NT (or 200x/XP) client, as is discussed in the following paragraphs.

Be aware that a valid Device Mode can only be initiated by a printer admin, or root (the reason should be obvious). Device Modes can only be correctly set by executing the printer driver program itself. Since Samba cannot execute this Win32 platform driver code, it sets this field initially to NULL (which is not a valid setting for clients to use). Fortunately, most drivers automatically generate the Printer Driver Data that is needed when they are uploaded to the *[print\$]* share with the help of the APW or rpcclient.

The generation and setting of a first valid Device Mode, however, requires some tickling from a client, to set it on the Samba server. The easiest means of doing so is to simply change the page orientation on the server's printer. This executes enough of the printer driver program on the client for the desired effect to happen, and feeds back the new Device Mode to our Samba server. You can use the native Windows NT/200x/XP printer properties page from a Window client for this:

1. Browse the **Network Neighborhood**.
2. Find the Samba server.
3. Open the Samba server's **Printers and Faxes** folder.
4. Highlight the shared printer in question.
5. Right-click on the printer (you may already be here, if you followed the last section's description).
6. At the bottom of the context menu select **Properties** (if the menu still offers the **Connect** entry further above, you need to click on that one first to achieve the driver installation as shown in the last section).
7. Go to the **Advanced** tab; click on **Printing Defaults**.
8. Change the **Portrait** page setting to **Landscape** (and back).
9. Make sure to apply changes between swapping the page orientation to cause the change to actually take effect.
10. While you are at it, you may also want to set the desired printing defaults here, which then apply to all future client driver installations on the remaining from now on.

This procedure has executed the printer driver program on the client platform and fed back the correct Device Mode to Samba, which now stored it in its TDB files. Once the driver is installed on the client, you can follow the analogous steps by accessing the *local* **Printers** folder, too, if you are a Samba printer admin user. From now on, printing should work as expected.

Samba includes a service level parameter name *default devmode* for generating a default Device Mode for a printer. Some drivers will function well with Samba's default set of properties. Others may crash the client's spooler service. So use this parameter with caution. It is always better to have the client generate a valid device mode for the printer and store it on the server for you.

18.7.3 Additional Client Driver Installation

Every additional driver may be installed, along the lines described above. Browse network, open the **Printers** folder on Samba server, right-click on **Printer** and choose **Connect...** Once this completes (should be not more than a few seconds, but could also take a minute, depending on network conditions), you should find the new printer in your client workstation local **Printers and Faxes** folder.

You can also open your local **Printers and Faxes** folder by using this command on Windows 200x/XP Professional workstations:

```
rundll32 shell32.dll,SHHelpShortcuts_RunDLL PrintersFolder
```

or this command on Windows NT 4.0 workstations:

```
rundll32 shell32.dll,Control_RunDLL MAIN.CPL @2
```

You can enter the commands either inside a **DOS box** window or in the **Run command...** field from the **Start** menu.

18.7.4 Always Make First Client Connection as root or “*printer admin*”

After you installed the driver on the Samba server (in its [*print\$*] share, you should always make sure that your first client installation completes correctly. Make it a habit for yourself to build the very first connection from a client as printer admin. This is to make sure that:

- A first valid *Device Mode* is really initialized (see above for more explanation details).
- The default print settings of your printer for all further client installations are as you want them.

Do this by changing the orientation to landscape, click on **Apply**, and then change it back again. Next, modify the other settings (for example, you do not want the default media size set to **Letter** when you are all using **A4**, right? You may want to set the printer for **duplex** as the default, and so on).

To connect as root to a Samba printer, try this command from a Windows 200x/XP DOS box command prompt:

```
C:\> runas /netonly /user:root "rundll32 printui.dll,PrintUIEntry /p /t3 /n
  \\SAMBA-SERVER\printername"
```

You will be prompted for root’s Samba-password; type it, wait a few seconds, click on **Printing Defaults**, and proceed to set the job options that should be used as defaults by all clients. Alternately, instead of root you can name one other member of the printer admin from the setting.

Now all the other users downloading and installing the driver the same way (called “*Point’n’Print*”) will have the same defaults set for them. If you miss this step you’ll get a lot of Help Desk calls from your users, but maybe you like to talk to people.

18.8 Other Gotchas

Your driver is installed. It is now ready for Point'n'Print installation by the clients. You may have tried to download and use it onto your first client machine, but wait. Let's make sure you are acquainted first with a few tips and tricks you may find useful. For example, suppose you did not set the defaults on the printer, as advised in the preceding paragraphs. Your users complain about various issues (such as, "*We need to set the paper size for each job from Letter to A4 and it will not store it.*")

18.8.1 Setting Default Print Options for Client Drivers

The last sentence might be viewed with mixed feelings by some users and Admins. They have struggled for hours and could not arrive at a point where their settings seemed to be saved. It is not their fault. The confusing thing is that in the multi-tabbed dialog that pops up when you right-click on the printer name and select **Properties**, you can arrive at two dialogs that appear identical, each claiming that they help you to set printer options in three different ways. Here is the definite answer to the Samba default driver setting FAQ:

"I can not set and save default print options for all users on Windows 200x/XP. Why not?". How are you doing it? I bet the wrong way. (It is not easy to find out, though). There are three different ways to bring you to a dialog that seems to set everything. All three dialogs look the same, but only one of them does what you intend. You need to be Administrator or Print Administrator to do this for all users. Here is how I reproduce it in an XP Professional: The following list needs periods after the letters and numbers::::::::::

A The first "*wrong*" way: .

- 1 Open the **Printers** folder.
- 2 Right-click on the printer (*remoteprinter on cupshost*) and select in context menu **Printing Preferences...**
- 3 Look at this dialog closely and remember what it looks like.

B The second "*wrong*" way: . button.

- 1 Open the **Printers** folder.
- 2 Right-click on the printer (*remoteprinter on cupshost*) and select in the context menu **Properties**
- 3 Click on the **General** tab
- 4 Click on the **Printing Preferences...**
- 5 A new dialog opens. Keep this dialog open and go back to the parent dialog.

C The third and correct way: (should you do this from the beginning, just carry out steps 1 and 2 from the second method above).

- 1 Click on the **Advanced** tab. (If everything is "*grayed out*," then you are not logged in as a user with enough privileges).
- 2 Click on the **Printing Defaults** button.

- 3 On any of the two new tabs, click on the **Advanced** button.
- 4 A new dialog opens. Compare this one to the other. Are they identical looking comparing one from “B.5” and one from A.3”.

Do you see any difference in the two settings dialogs? I do not either. However, only the last one, which you arrived at with steps C.1 through 6 will permanently save any settings which will then become the defaults for new users. If you want all clients to have the same defaults, you need to conduct these steps as administrator (printer admin in) before a client downloads the driver (the clients can later set their own per-user defaults by following procedures A or B above). Windows 200x/XP allow per-user default settings and the ones the administrator gives them, before they set up their own. The parents of the identically-looking dialogs have a slight difference in their window names; one is called **Default Print Values for Printer Foo on Server Bar** (which is the one you need) and the other is called “*Print Settings for Printer Foo on Server Bar*”. The last one is the one you arrive at when you right-click on the printer and select **Print Settings....** This is the one that you were taught to use back in the days of Windows NT, so it is only natural to try the same way with Windows 200x/XP. You would not dream that there is now a different path to arrive at an identically looking, but functionally different, dialog to set defaults for all users.

TIP

Try (on Windows 200x/XP) to run this command (as a user with the right privileges):

```
rundll32 printui.dll,PrintUIEntry /p /t3 /n\\SAMBA-  
SERVER\printersharename
```



To see the tab with the **Printing Defaults** button (the one you need), also run this command:

```
rundll32 printui.dll,PrintUIEntry /p /t0 /n\\SAMBA-  
SERVER\printersharename
```

To see the tab with the **Printing Preferences** button (the one which does not set system-wide defaults), you can start the commands from inside a DOS box” or from **Start -> Run**.

18.8.2 Supporting Large Numbers of Printers

One issue that has arisen during the recent development phase of Samba is the need to support driver downloads for hundreds of printers. Using Windows NT APW here is somewhat awkward (to say the least). If you do not want to acquire RSS pains from the printer installation clicking orgy alone, you need to think about a non-interactive script.

If more than one printer is using the same driver, the **rpcclient setdriver** command can

be used to set the driver associated with an installed queue. If the driver is uploaded to *[print\$]* once and registered with the printing TDBs, it can be used by multiple print queues. In this case, you just need to repeat the **setprinter** subcommand of **rpcclient** for every queue (without the need to conduct the **adddriver** repeatedly). The following is an example of how this could be accomplished:

```
root# rpcclient SAMBA-CUPS -U root%secret -c 'enumdrivers'
cmd = enumdrivers
```

```
[Windows NT x86]
```

```
Printer Driver Info 1:
```

```
Driver Name: [infotec IS 2075 PCL 6]
```

```
Printer Driver Info 1:
```

```
Driver Name: [DANKA InfoStream]
```

```
Printer Driver Info 1:
```

```
Driver Name: [Heidelberg Digimaster 9110 (PS)]
```

```
Printer Driver Info 1:
```

```
Driver Name: [dm9110]
```

```
Printer Driver Info 1:
```

```
Driver Name: [mydrivername]
```

```
[....]
```

```
root# rpcclient SAMBA-CUPS -U root%secret -c 'enumprinters'
cmd = enumprinters
flags:[0x800000]
name:[\\SAMBA-CUPS\dm9110]
description:[\\SAMBA-CUPS\dm9110,,110ppm HiVolume DANKA Stuttgart]
comment:[110 ppm HiVolume DANKA Stuttgart]
[....]
```

```
root# rpcclient SAMBA-CUPS -U root%secret -c \
'setdriver dm9110 "Heidelberg Digimaster 9110 (PS)"'
cmd = setdriver dm9110 Heidelberg Digimaster 9110 (PPD)
Successfully set dm9110 to driver Heidelberg Digimaster 9110 (PS).
```

```
root# rpcclient SAMBA-CUPS -U root%secret -c 'enumprinters'
cmd = enumprinters
flags:[0x800000]
```

```

name:[\\SAMBA-CUPS\dm9110]
description:[\\SAMBA-CUPS\dm9110,Heidelberg Digimaster 9110 (PS),\
  110ppm HiVolume DANKA Stuttgart]
comment:[110ppm HiVolume DANKA Stuttgart]
[....]

```

```

root# rpcclient SAMBA-CUPS -U root%secret -c 'setdriver dm9110 mydrivername'
cmd = setdriver dm9110 mydrivername
Successfully set dm9110 to mydrivername.

```

```

root# rpcclient SAMBA-CUPS -U root%secret -c 'enumprinters'
cmd = enumprinters
flags:[0x800000]
name:[\\SAMBA-CUPS\dm9110]
description:[\\SAMBA-CUPS\dm9110,mydrivername,\
  110ppm HiVolume DANKA Stuttgart]
comment:[110ppm HiVolume DANKA Stuttgart]
[....]

```

It may not be easy to recognize that the first call to **enumprinters** showed the “*dm9110*” printer with an empty string where the driver should have been listed (between the 2 commas in the description field). After the **setdriver** command succeeded, all is well.

18.8.3 Adding New Printers with the Windows NT APW

By default, Samba exhibits all printer shares defined in `smb.conf` in the **Printers** folder. Also located in this folder is the Windows NT Add Printer Wizard icon. The APW will be shown only if:

- The connected user is able to successfully execute an **OpenPrinterEx(\\server)** with administrative privileges (i.e., root or printer admin).

TIP

Try this from a Windows 200x/XP DOS box command prompt:



```

runas /netonly /user:root rundll32 printui.
dll,PrintUIEntry /p /t0 /n \\SAMBA-
SERVER\printersharename

```

Click on **Printing Preferences**.

- ... contains the setting `show add printer wizard = yes` (the default).

The APW can do various things:

- Upload a new driver to the Samba `[print$]` share.
- Associate an uploaded driver with an existing (but still driverless) print queue.
- Exchange the currently used driver for an existing print queue with one that has been uploaded before.
- Add an entirely new printer to the Samba host (only in conjunction with a working add printer command. A corresponding delete printer command for removing entries from the **Printers** folder may also be provided).

The last one (add a new printer) requires more effort than the previous ones. To use the APW to successfully add a printer to a Samba server, the add printer command must have a defined value. The program hook must successfully add the printer to the UNIX print system (i.e., to `/etc/printcap`, `/etc/cups/printers.conf` or other appropriate files) and to `smb.conf` if necessary.

When using the APW from a client, if the named printer share does not exist, `smbd` will execute the add printer command and re-`parse` to the to attempt to locate the new printer share. If the share is still not defined, an error of Access Denied is returned to the client. The add printer command is executed under the context of the connected user, not necessarily a root account. A map to `guest = bad user` may have connected you unwittingly under the wrong privilege. You should check it by using the `smbstatus` command.

18.8.4 Error Message: “Cannot connect under a different Name”

Once you are connected with the wrong credentials, there is no means to reverse the situation other than to close all Explorer Windows, and perhaps reboot.

- The `net use \\SAMBA-SERVER\sharename /user:root` gives you an error message: *“Multiple connections to a server or a shared resource by the same user utilizing the several user names are not allowed. Disconnect all previous connections to the server, esp. the shared resource, and try again.”*
- Every attempt to “connect a network drive” to `\\SAMBASERVER\print$` to `z:` is countered by the pertinacious message: *“This network folder is currently connected under different credentials (username and password). Disconnect first any existing connection to this network share in order to connect again under a different username and password”*.

So you close all connections. You try again. You get the same message. You check from the Samba side, using `smbstatus`. Yes, there are more connections. You kill them all. The client still gives you the same error message. You watch the `smbd.log` file on a high debug level and try reconnect. Same error message, but not a single line in the log. You start to wonder if there was a connection attempt at all. You run `ethereal` and `tcpdump` while you try to connect. Result: not a single byte goes on the wire. Windows still gives the error message. You close all Explorer windows and start it again. You try to connect — and this times it works! Windows seems to cache connection information somewhere and does

not keep it up-to-date (if you are unlucky you might need to reboot to get rid of the error message).

The easiest way to forcefully terminate all connections from your client to a server is by executing:

```
C:\> net use * /delete
```

This will disconnect all mapped drives also and will allow you create fresh connection as required.

18.8.5 Take Care When Assembling Driver Files

You need to be extremely careful when you take notes about the files and belonging to a particular driver. Don't confuse the files for driver version "0" (for Windows 9x/Me, going into [print\$]/WIN/0/), driver version 2 (Kernel Mode driver for Windows NT, going into [print\$]/W32X86/2/ may be used on Windows 200x/XP also), and driver version "3" (non-Kernel Mode driver going into [print\$]/W32X86/3/ cannot be used on Windows NT). Quite often these different driver versions contain files that have the same name but actually are very different. If you look at them from the Windows Explorer (they reside in %WINDOWS%\system32\spool\drivers\W32X86\), you will probably see names in capital letters, while an `enumdrivers` command from Samba would show mixed or lower case letters. So it is easy to confuse them. If you install them manually using `rpcclient` and subcommands, you may even succeed without an error message. Only later, when you try install on a client, you will encounter error messages like `This server has no appropriate driver for the printer.`

Here is an example. You are invited to look closely at the various files, compare their names and their spelling, and discover the differences in the composition of the version 2 and 3 sets. Note: the version 0 set contained 40 *Dependentfiles*, so I left it out for space reasons:

```
root# rpcclient -U 'Administrator%secret' -c 'enumdrivers 3' 10.160.50.8
```

```
Printer Driver Info 3:
```

```
Version: [3]
```

```
Driver Name: [Canon iR8500 PS3]
```

```
Architecture: [Windows NT x86]
```

```
Driver Path: [\\10.160.50.8\print$\W32X86\3\cns3g.dll]
```

```
Datafile: [\\10.160.50.8\print$\W32X86\3\iR8500sg.xpd]
```

```
Configfile: [\\10.160.50.8\print$\W32X86\3\cns3gui.dll]
```

```
Helpfile: [\\10.160.50.8\print$\W32X86\3\cns3g.hlp]
```

```
Dependentfiles: [\\10.160.50.8\print$\W32X86\3\aucplmNT.dll]
```

```
Dependentfiles: [\\10.160.50.8\print$\W32X86\3\ucs32p.dll]
```

```
Dependentfiles: [\\10.160.50.8\print$\W32X86\3\tnl32.dll]
```

```
Dependentfiles: [\\10.160.50.8\print$\W32X86\3\ausssrv.dll]
```

```
Dependentfiles: [\\10.160.50.8\print$\W32X86\3\cnspsc.dll]
```

```

Dependentfiles: [\\10.160.50.8\print$\W32X86\3\aussapi.dat]
Dependentfiles: [\\10.160.50.8\print$\W32X86\3\cns3407.dll]
Dependentfiles: [\\10.160.50.8\print$\W32X86\3\CnS3G.cnt]
Dependentfiles: [\\10.160.50.8\print$\W32X86\3\NBAPI.DLL]
Dependentfiles: [\\10.160.50.8\print$\W32X86\3\NBIPC.DLL]
Dependentfiles: [\\10.160.50.8\print$\W32X86\3\cpcview.exe]
Dependentfiles: [\\10.160.50.8\print$\W32X86\3\cpcdsp1.exe]
Dependentfiles: [\\10.160.50.8\print$\W32X86\3\cpcedit.dll]
Dependentfiles: [\\10.160.50.8\print$\W32X86\3\cpcqm.exe]
Dependentfiles: [\\10.160.50.8\print$\W32X86\3\cpcsp1.dll]
Dependentfiles: [\\10.160.50.8\print$\W32X86\3\cfine32.dll]
Dependentfiles: [\\10.160.50.8\print$\W32X86\3\cpcr407.dll]
Dependentfiles: [\\10.160.50.8\print$\W32X86\3\Cpcqm407.hlp]
Dependentfiles: [\\10.160.50.8\print$\W32X86\3\cpcqm407.cnt]
Dependentfiles: [\\10.160.50.8\print$\W32X86\3\cns3ggr.dll]

```

```

Monitorname: []
Defaultdatatype: []

```

Printer Driver Info 3:

```

Version: [2]
Driver Name: [Canon iR5000-6000 PS3]
Architecture: [Windows NT x86]
Driver Path: [\\10.160.50.8\print$\W32X86\2\cns3g.dll]
Datafile: [\\10.160.50.8\print$\W32X86\2\IR5000sg.xpd]
Configfile: [\\10.160.50.8\print$\W32X86\2\cns3gui.dll]
Helpfile: [\\10.160.50.8\print$\W32X86\2\cns3g.hlp]

```

```

Dependentfiles: [\\10.160.50.8\print$\W32X86\2\AUCPLMNT.DLL]
Dependentfiles: [\\10.160.50.8\print$\W32X86\2\aussdrv.dll]
Dependentfiles: [\\10.160.50.8\print$\W32X86\2\cnspsc.dll]
Dependentfiles: [\\10.160.50.8\print$\W32X86\2\aussapi.dat]
Dependentfiles: [\\10.160.50.8\print$\W32X86\2\cns3407.dll]
Dependentfiles: [\\10.160.50.8\print$\W32X86\2\CnS3G.cnt]
Dependentfiles: [\\10.160.50.8\print$\W32X86\2\NBAPI.DLL]
Dependentfiles: [\\10.160.50.8\print$\W32X86\2\NBIPC.DLL]
Dependentfiles: [\\10.160.50.8\print$\W32X86\2\cns3gum.dll]

```

```

Monitorname: [CPCA Language Monitor2]
Defaultdatatype: []

```

If we write the “*version 2*” files and the “*version 3*” files into different text files and compare the result, we see this picture:

```
root# sdiff 2-files 3-files
```

```

cns3g.dll                cns3g.dll
iR8500sg.xpd             iR8500sg.xpd
cns3gui.dll              cns3gui.dll
cns3g.hlp                cns3g.hlp
AUCPLMNT.DLL            | aucplmNT.dll
                        > ucs32p.dll
                        > tnl32.dll

aussdrv.dll              aussdrv.dll
cnspdc.dll               cnspdc.dll
aussapi.dat              aussapi.dat
cns3407.dll              cns3407.dll
CnS3G.cnt                CnS3G.cnt
NBAPI.DLL                NBAPI.DLL
NBIPC.DLL                NBIPC.DLL
cns3gum.dll              | cpcview.exe
                        > cpcdsp1.exe
                        > cpcqm.exe
                        > cpcspl.dll
                        > cfine32.dll
                        > cpcr407.dll
                        > Cpcqm407.hlp
                        > cpcqm407.cnt
                        > cns3ggr.dll

```

Do not be fooled! Driver files for each version with identical names may be different in their content, as you can see from this size comparison:

```

root# for i in cns3g.hlp cns3gui.dll cns3g.dll; do          \
    smbclient //10.160.50.8/print/$ -U 'Administrator%xxxx' \
    -c "cd W32X86/3; dir $i; cd .. ; cd 2; dir $i";        \
done

```

```

CNS3G.HLP                A    122981  Thu May 30 02:31:00 2002
CNS3G.HLP                A     99948  Thu May 30 02:31:00 2002

CNS3GUI.DLL              A   1805824  Thu May 30 02:31:00 2002
CNS3GUI.DLL              A   1785344  Thu May 30 02:31:00 2002

CNS3G.DLL                A   1145088  Thu May 30 02:31:00 2002
CNS3G.DLL                A    15872   Thu May 30 02:31:00 2002

```

In my example were even more differences than shown here. Conclusion: you must be careful to select the correct driver files for each driver version. Don't rely on the names alone and don't interchange files belonging to different driver versions.

18.8.6 Samba and Printer Ports

Windows NT/2000 print servers associate a port with each printer. These normally take the form of LPT1:, COM1:, FILE:, and so on. Samba must also support the concept of ports associated with a printer. By default, only one printer port, named “*Samba Printer Port*”, exists on a system. Samba does not really need such a “*port*” in order to print; rather it is a requirement of Windows clients. They insist on being told about an available port when they request this information, otherwise they throw an error message at you. So Samba fakes the port information to keep the Windows clients happy.

Samba does not support the concept of **Printer Pooling** internally either. Printer Pooling assigns a logical printer to multiple ports as a form of load balancing or fail over.

If you require multiple ports be defined for some reason or another (my users and my boss should not know that they are working with Samba), configure `enumports` command which can be used to define an external program that generates a listing of ports on a system.

18.8.7 Avoiding Common Client Driver Mis-configuration

So now the printing works, but there are still problems. Most jobs print well, some do not print at all. Some jobs have problems with fonts, which do not look good. Some jobs print fast and some are dead-slow. We cannot cover it all, but we want to encourage you to read the brief paragraph about “*Avoiding the Wrong PostScript Driver Settings*” in the CUPS Printing part of this document.

18.9 The Imprints Tool-set

The Imprints tool set provides a UNIX equivalent of the Windows NT Add Printer Wizard. For complete information, please refer to the Imprints <<http://imprints.sourceforge.net/>> Web site as well as the documentation included with the imprints source distribution. This section only provides a brief introduction to the features of Imprints.

Unfortunately, the Imprints tool-set is no longer maintained. As of December 2000, the project is in need of a new maintainer. The most important skill to have is Perl coding and an interest in MS-RPC-based printing used in Samba. If you wish to volunteer, please coordinate your efforts on the Samba technical mailing list. The tool-set is still in usable form, but only for a series of older printer models where there are prepared packages to use. Packages for more up-to-date print devices are needed if Imprints should have a future.

18.9.1 What is Imprints?

Imprints is a collection of tools for supporting these goals:

- Providing a central repository of information regarding Windows NT and 95/98 printer driver packages.
- Providing the tools necessary for creating the Imprints printer driver packages.

- Providing an installation client that will obtain printer drivers from a central Internet (or intranet) Imprints Server repository and install them on remote Samba and Windows NT4 print servers.

18.9.2 Creating Printer Driver Packages

The process of creating printer driver packages is beyond the scope of this document (refer to `Imprints.txt` also included with the Samba distribution for more information). In short, an Imprints driver package is a gzipped tarball containing the driver files, related INF files, and a control file needed by the installation client.

18.9.3 The Imprints Server

The Imprints server is really a database server that may be queried via standard HTTP mechanisms. Each printer entry in the database has an associated URL for the actual downloading of the package. Each package is digitally signed via GnuPG which can be used to verify that the package downloaded is actually the one referred in the Imprints database. It is strongly recommended that this security check not be disabled.

18.9.4 The Installation Client

More information regarding the Imprints installation client is available from the the documentation file `Imprints-Client-HOWTO.ps` that is included with the Imprints source package. The Imprints installation client comes in two forms:

- A set of command line Perl scripts.
- A GTK+ based graphical interface to the command line Perl scripts.

The installation client (in both forms) provides a means of querying the Imprints database server for a matching list of known printer model names as well as a means to download and install the drivers on remote Samba and Windows NT print servers.

The basic installation process is in four steps and Perl code is wrapped around `smbclient` and `rpcclient`.

- For each supported architecture for a given driver:
 1. `rpcclient`: Get the appropriate upload directory on the remote server.
 2. `smbclient`: Upload the driver files.
 3. `rpcclient`: Issues an `AddPrinterDriver()` MS-RPC.
- `rpcclient`: Issue an `AddPrinterEx()` MS-RPC to actually create the printer.

One of the problems encountered when implementing the Imprints tool set was the name space issues between various supported client architectures. For example, Windows NT includes a driver named “*Apple LaserWriter II NTX v51.8*” and Windows 95 calls its version of this driver “*Apple LaserWriter II NTX*”.

The problem is how to know what client drivers have been uploaded for a printer. An astute reader will remember that the Windows NT Printer Properties dialog only includes space for one printer driver name. A quick look in the Windows NT 4.0 system registry at:

```
HKLM\System\CurrentControlSet\Control\Print\Environment
```

will reveal that Windows NT always uses the NT driver name. This is okay as Windows NT always requires that at least the Windows NT version of the printer driver is present. Samba does not have the requirement internally, therefore, "*How can you use the NT driver name if it has not already been installed?*"

The way of sidestepping this limitation is to require that all Imprints printer driver packages include both the Intel Windows NT and 95/98 printer drivers and that the NT driver is installed first.

18.10 Adding Network Printers without User Interaction

The following MS Knowledge Base article may be of some help if you need to handle Windows 2000 clients: *How to Add Printers with No User Interaction in Windows 2000*, (<<http://support.microsoft.com/default.aspx?scid=kb;en-us;189105>>). It also applies to Windows XP Professional clients. The ideas sketched out in this section are inspired by this article, which describes a command-line method that can be applied to install network and local printers and their drivers. This is most useful if integrated in Logon Scripts. You can see what options are available by typing in the command prompt (**DOS box**):

```
rundll32 printui.dll,PrintUIEntry /?
```

A window pops up that shows you all of the command-line switches available. An extensive list of examples is also provided. This is only for Win 200x/XP, it does not work on Windows NT. Windows NT probably has some other tools in the respective Resource Kit. Here is a suggestion about what a client logon script might contain, with a short explanation of what the lines actually do (it works if 200x/XP Windows clients access printers via Samba, and works for Windows-based print servers too):

```
rundll32 printui.dll,PrintUIEntry /dn /n "\\cupsserver\infotec2105-IPDS" /q
rundll32 printui.dll,PrintUIEntry /in /n "\\cupsserver\infotec2105-PS"
rundll32 printui.dll,PrintUIEntry /y /n "\\cupsserver\infotec2105-PS"
```

Here is a list of the used command-line parameters:

/dn deletes a network printer

/q quiet modus

/n names a printer

/in adds a network printer connection

`/y` sets printer as default printer

- Line 1 deletes a possibly existing previous network printer *infotec2105-IPDS* (which had used native Windows drivers with LPRng that were removed from the server that was converted to CUPS). The `/q` at the end eliminates Confirm or error dialog boxes from popping up. They should not be presented to the user logging on.
- Line 2 adds the new printer *infotec2105-PS* (which actually is the same physical device but is now run by the new CUPS printing system and associated with the CUPS/Adobe PS drivers). The printer and its driver must have been added to Samba prior to the user logging in (e.g., by a procedure as discussed earlier in this chapter, or by running `cupsaddsmb`). The driver is now auto-downloaded to the client PC where the user is about to log in.
- Line 3 sets the default printer to this new network printer (there might be several other printers installed with this same method and some may be local as well, so we decide for a default printer). The default printer selection may, of course, be different for different users.

The second line only works if the printer *infotec2105-PS* has an already working print queue on the `cupsserver`, and if the printer drivers have been successfully uploaded (via the `APW`, `smbclient/rpcclient`, or `cupsaddsmb`) into the `[print$]` driver repository of Samba. Some Samba versions prior to version 3.0 required a re-start of `smbd` after the printer install and the driver upload, otherwise the script (or any other client driver download) would fail.

Since there no easy way to test for the existence of an installed network printer from the logon script, do not bother checking, just allow the de-installation/re-installation to occur every time a user logs in; it's really quick anyway (1 to 2 seconds).

The additional benefits for this are:

- It puts in place any printer default setup changes automatically at every user logon.
- It allows for “*roaming*” users’ login into the domain from different workstations.

Since network printers are installed per user, this much simplifies the process of keeping the installation up-to-date. The few extra seconds at logon time will not really be noticeable. Printers can be centrally added, changed and deleted at will on the server with no user intervention required from the clients (you just need to keep the logon scripts up-to-date).

18.11 The `addprinter` Command

The `addprinter` command can be configured to be a shell script or program executed by Samba. It is triggered by running the `APW` from a client against the Samba print server. The `APW` asks the user to fill in several fields (such as printer name, driver to be used, comment, port monitor, and so on). These parameters are passed on to Samba by the `APW`. If the `addprinter` command is designed in a way that it can create a new printer (through writing correct `printcap` entries on legacy systems, or execute the `lpadmin` command on

more modern systems) and create the associated share in, then the APW will in effect really create a new printer on Samba and the UNIX print subsystem!

18.12 Migration of Classical Printing to Samba

The basic NT-style printer driver management has not changed considerably in 3.0 over the 2.2.x releases (apart from many small improvements). Here migration should be quite easy, especially if you followed previous advice to stop using deprecated parameters in your setup. For migrations from an existing 2.0.x setup, or if you continued Windows 9x/Me-style printing in your Samba 2.2 installations, it is more of an effort. Please read the appropriate release notes and the HOWTO Collection for Samba-2.2.x. You can follow several paths. Here are possible scenarios for migration:

- You need to study and apply the new Windows NT printer and driver support. Previously used parameters *printer driver file*, *printer driver* and *printer driver location* are no longer supported.
- If you want to take advantage of Windows NT printer driver support, you also need to migrate the Windows 9x/Me drivers to the new setup.
- An existing `printers.def` file (the one specified in the now removed parameter *printer driver file*) will no longer work with Samba-3. In 3.0, `smbd` attempts to locate a Windows 9x/Me driver files for the printer in `[print$]` and additional settings in the TDB and only there; if it fails, it will *not* (as 2.2.x used to do) drop down to using a `printers.def` (and all associated parameters). The `make_printerdef` tool is removed and there is no backward compatibility for this.
- You need to install a Windows 9x/Me driver into the `[print$]` share for a printer on your Samba host. The driver files will be stored in the “`WIN40/0`” subdirectory of `[print$]`, and some other settings and information go into the printing-related TDBs.
- If you want to migrate an existing `printers.def` file into the new setup, the only current solution is to use the Windows NT APW to install the NT drivers and the 9x/Me drivers. This can be scripted using `smbclient` and `rpcclient`. See the Imprints installation client at:

`<http://imprints.sourceforge.net/>`

for an example. See also the discussion of `rpcclient` usage in the “*CUPS Printing*” section.

18.13 Publishing Printer Information in Active Directory or LDAP

This will be addressed in a later update of this document. If you wish to volunteer your services to help document this, please contact John H Terpstra. `<mail://jht@samba.org>`

18.14 Common Errors

18.14.1 I Give My Root Password but I Do Not Get Access

Do not confuse the root password which is valid for the UNIX system (and in most cases stored in the form of a one-way hash in a file named `/etc/shadow`), with the password used to authenticate against Samba. Samba does not know the UNIX password. Root access to Samba resources requires that a Samba account for root must first be created. This is done with the `smbpasswd` command as follows:

```
root# smbpasswd -a root
New SMB password: secret
Retype new SMB password: secret
```

18.14.2 My Print Jobs Get Spooled into the Spooling Directory, but Then Get Lost

Do not use the existing UNIX print system spool directory for the Samba spool directory. It may seem convenient and a savings of space, but it only leads to problems. The two must be separate.

CUPS PRINTING SUPPORT

19.1 Introduction

19.1.1 Features and Benefits

The Common UNIX Print System (CUPS <<http://www.cups.org/>>) has become quite popular. All major Linux distributions now ship it as their default printing system. To many, it is still a mystical tool. Mostly, it just works. People tend to regard it as a “*black box*” that they do not want to look into as long as it works. But once there is a little problem, they are in trouble to find out where to start debugging it. Refer to the chapter “*Classical Printing*” that contains a lot of information that is relevant for CUPS.

CUPS sports quite a few unique and powerful features. While their basic functions may be grasped quite easily, they are also new. Because they are different from other, more traditional printing systems, it is best not to try and apply any prior knowledge about printing to this new system. Rather, try to understand CUPS from the beginning. This documentation will lead you to a complete understanding of CUPS. Let’s start with the most basic things first.

19.1.2 Overview

CUPS is more than just a print spooling system. It is a complete printer management system that complies with the new Internet Printing Protocol (IPP). IPP is an industry and Internet Engineering Task Force (IETF) standard for network printing. Many of its functions can be managed remotely (or locally) via a Web browser (giving you a platform-independent access to the CUPS print server). Additionally, it has the traditional command line and several more modern GUI interfaces (GUI interfaces developed by third parties, like KDE’s overwhelming KDEPrint <<http://printing.kde.org/>>).

CUPS allows creation of “*raw*” printers (i.e., no print file format translation) as well as “*smart*” printers (i.e., CUPS does file format conversion as required for the printer). In many ways this gives CUPS similar capabilities to the MS Windows print monitoring system. Of course, if you are a CUPS advocate, you would argue that CUPS is better! In any case, let us now move on to explore how one may configure CUPS for interfacing with MS Windows print clients via Samba.

19.2 Basic CUPS Support Configuration

Printing with CUPS in the most basic `smb.conf` setup in Samba-3.0 (as was true for 2.2.x) only needs two settings: `printing = cups` and `printcap = cups`. CUPS does not need a `printcap` file. However, the `cupsd.conf` configuration file knows of two related directives that control how such a file will be automatically created and maintained by CUPS for the convenience of third-party applications (example: `Printcap /etc/printcap` and `PrintcapFormat BSD`). Legacy programs often require the existence of a `printcap` file containing printer names or they will refuse to print. Make sure CUPS is set to generate and maintain a `printcap` file. For details, see **man `cupsd.conf`** and other CUPS-related documentation, like the wealth of documents on your CUPS server itself: `<http://localhost:631/documentation.html>`.

19.2.1 Linking `smbd` with `libcups.so`

Samba has a special relationship to CUPS. Samba can be compiled with CUPS library support. Most recent installations have this support enabled. Per default, CUPS linking is compiled into `smbd` and other Samba binaries. Of course, you can use CUPS even if Samba is not linked against `libcups.so` — but there are some differences in required or supported configuration.

When Samba is compiled against `libcups`, `printcap = cups` uses the CUPS API to list printers, submit jobs, query queues, and so on. Otherwise it maps to the System V commands with an additional `-oraw` option for printing. On a Linux system, you can use the **ldd** utility to find out details (`ldd` may not be present on other OS platforms, or its function may be embodied by a different command):

```
root# ldd 'which smbd'
libssl.so.0.9.6 => /usr/lib/libssl.so.0.9.6 (0x4002d000)
libcrypto.so.0.9.6 => /usr/lib/libcrypto.so.0.9.6 (0x4005a000)
libcups.so.2 => /usr/lib/libcups.so.2 (0x40123000)
[...]
```

The line `libcups.so.2 => /usr/lib/libcups.so.2 (0x40123000)` shows there is CUPS support compiled into this version of Samba. If this is the case, and `printing = cups` is set, then *any otherwise manually set print command in `smb.conf` is ignored*. This is an important point to remember!

TIP



Should it be necessary, for any reason, to set your own print commands, you can do this by setting `printing = sysv`. However, you will lose all the benefits of tight CUPS/Samba integration. When you do this you must manually configure the printing system commands (most important: `print command`; other commands are `lppause command`, `lpresume command`, `lpq command`, `lprm command`, `queuepause command` and `queue resume command`).

19.2.2 Simple `smb.conf` Settings for CUPS

To summarize, following example shows simplest printing-related setup for `smb.conf` to enable basic CUPS support:

Example 19.2.1. Simplest printing-related `smb.conf`

```
[global]
    load printers = yes
    printing = cups
    printcap name = cups

[printers]
    comment = All Printers
    path = /var/spool/samba
    browseable = no
    public = yes
    guest ok = yes
    writable = no
    printable = yes
    printer admin = root, @ntadmins
```

This is all you need for basic printing setup for CUPS. It will print all graphic, text, PDF, and PostScript files submitted from Windows clients. However, most of your Windows users would not know how to send these kinds of files to print without opening a GUI application. Windows clients tend to have local printer drivers installed, and the GUI application's print buttons start a printer driver. Your users also rarely send files from the command line. Unlike UNIX clients, they hardly submit graphic, text or PDF formatted files directly to the spooler. They nearly exclusively print from GUI applications with a “*printer driver*” hooked in between the application's native format and the `print-data-stream`. If the backend printer is not a PostScript device, the print data stream is “*binary*,” sensible only for the target printer. Read on to learn which problem this may cause and how to avoid it.

19.2.3 More Complex CUPS smb.conf Settings

Next configuration is a slightly more complex printing-related setup for `smb.conf`. It enables general CUPS printing support for all printers, but defines one printer share, which is set up differently.

Example 19.2.2. Overriding global CUPS settings for one printer

```
[global]
    printing = cups
    printcap name = cups
    load printers = yes

[printers]
    comment = All Printers
    path = /var/spool/samba
    public = yes
    guest ok = yes
    writable = no
    printable = yes
    printer admin = root, @ntadmins

[special_printer]
    comment = A special printer with his own settings
    path = /var/spool/samba-special
    printing = sysv
    printcap = lpstat
    print command = echo "NEW: 'date': printfile %f" \
>> /tmp/smbprn.log ; \
echo " 'date':  p-%p s-%s f-%f" >> /tmp/smbprn.log ; \
echo " 'date':  j-%j J-%J z-%z c-%c" >> /tmp/smbprn.log ; rm %f
    public = no
    guest ok = no
    writable = no
    printable = yes
    printer admin = kurt
    hosts deny = 0.0.0.0
    hosts allow = turbo_xp, 10.160.50.23, 10.160.51.60
```

This special share is only there for testing purposes. It does not write the print job to a file. It just logs the job parameters known to Samba into the `/tmp/smbprn.log` file and deletes the job-file. Moreover, the printer admin of this share is “kurt” (not the “@ntadmins” group), guest access is not allowed, the share isn’t published to the Network Neighborhood (so you need to know it is there), and it only allows access from only three hosts. To prevent CUPS kicking in and taking over the print jobs for that share, we need to set `printing = sysv` and `printcap = lpstat`.

19.3 Advanced Configuration

Before we delve into all the configuration options, let us clarify a few points. *Network printing needs to be organized and setup correctly.* This frequently doesn't happen. Legacy systems or small business LAN environments often lack design and good housekeeping.

19.3.1 Central Spooling vs. “Peer-to-Peer” Printing

Many small office or home networks, as well as badly organized larger environments, allow each client a direct access to available network printers. This is generally a bad idea. It often blocks one client's access to the printer when another client's job is printing. It might freeze the first client's application while it is waiting to get rid of the job. Also, there are frequent complaints about various jobs being printed with their pages mixed with each other. A better concept is the usage of a print server: it routes all jobs through one central system, which responds immediately, takes jobs from multiple concurrent clients at the same time, and in turn transfers them to the printer(s) in the correct order.

19.3.2 Raw Print Serving — Vendor Drivers on Windows Clients

Most traditionally configured UNIX print servers acting on behalf of Samba's Windows clients represented a really simple setup. Their only task was to manage the “*raw*” spooling of all jobs handed to them by Samba. This approach meant that the Windows clients were expected to prepare the print job file that its ready to be sent to the printing device. Here a native (vendor-supplied) Windows printer driver needs to be installed on each and every client for the target device.

It is possible to configure CUPS, Samba and your Windows clients in the same traditional and simple way. When CUPS printers are configured for RAW print-through mode operation, it is the responsibility of the Samba client to fully render the print job (file). The file must be sent in a format that is suitable for direct delivery to the printer. Clients need to run the vendor-provided drivers to do this. In this case, CUPS will not do any print file format conversion work.

The easiest printing configuration possible is to use raw print-through. This is achieved by installation of the printer as if it was physically attached to the Windows client. You then redirect output to a raw network print queue. The following procedure may be followed to achieve this:

1. Edit `/etc/cups/mime.types` to uncomment the line near the end of the file that has:

```
#application/octet-...
```

2. Do the same for the file `/etc/cups/mime.convs`.
3. Add a raw printer using the Web interface. Point your browser at `http://localhost:631`. Enter Administration, add the printer following the prompts. Do not install any drivers for it. Choose Raw. Choose queue name `Raw Queue`.

4. In the `smb.conf` file `[printers]` section add `use client driver = Yes`, and in the `[global]` section add `printing = CUPS`, plus `printcap = CUPS`.
5. Install the printer as if it is a local printer. i.e.: `Printing to LPT1:`.
6. Edit the configuration under the **Detail** tab, create a `local port` that points to the raw printer queue that you have configured above. Example: `\\server\raw_q`. Here, the name `raw_q` is the name you gave the print queue in the CUPS environment.

19.3.3 Installation of Windows Client Drivers

The printer drivers on the Windows clients may be installed in two functionally different ways:

- Manually install the drivers locally on each client, one by one; this yields the old *LanMan* style printing and uses a `\\sambaserver\printershare` type of connection.
- Deposit and prepare the drivers (for later download) on the print server (Samba); this enables the clients to use “*Point’n’Print*” to get drivers semi-automatically installed the first time they access the printer; with this method NT/200x/XP clients use the *SPOOLSS/MS-RPC* type printing calls.

The second method is recommended for use over the first.

19.3.4 Explicitly Enable “raw” Printing for *application/octet-stream*

If you use the first option (drivers are installed on the client side), there is one setting to take care of: CUPS needs to be told that it should allow “raw” printing of deliberate (binary) file formats. The CUPS files that need to be correctly set for RAW mode printers to work are:

- `/etc/cups/mime.types`
- `/etc/cups/mime.convs`

Both contain entries (at the end of the respective files) which must be uncommented to allow RAW mode operation. In `/etc/cups/mime.types`, make sure this line is present:

```
application/octet-stream
```

In `/etc/cups/mime.convs`, have this line:

```
application/octet-stream application/vnd.cups-raw 0 -
```

If these two files are not set up correctly for raw Windows client printing, you may encounter the dreaded `Unable to convert file 0` in your CUPS `error_log` file.

NOTE



Editing the `mime.convs` and the `mime.types` file does not *enforce* “raw” printing, it only *allows* it.

Background. CUPS being a more security-aware printing system than traditional ones does not by default allow a user to send deliberate (possibly binary) data to printing devices. This could be easily abused to launch a “*Denial of Service*” attack on your printer(s), causing at least the loss of a lot of paper and ink. “*Unknown*” data are tagged by CUPS as *MIME type: application/octet-stream* and not allowed to go to the printer. By default, you can only send other (known) MIME types “raw”. Sending data “raw” means that CUPS does not try to convert them and passes them to the printer untouched (see the next chapter for even more background explanations).

This is all you need to know to get the CUPS/Samba combo printing “raw” files prepared by Windows clients, which have vendor drivers locally installed. If you are not interested in background information about more advanced CUPS/Samba printing, simply skip the remaining sections of this chapter.

19.3.5 Driver Upload Methods

This section describes three familiar methods, plus one new one, by which printer drivers may be uploaded.

If you want to use the MS-RPC type printing, you must upload the drivers onto the Samba server first (`[print$]` share). For a discussion on how to deposit printer drivers on the Samba host (so the Windows clients can download and use them via “*Point’n’Print*”), please refer to the previous chapter of this HOWTO Collection. There you will find a description or reference to three methods of preparing the client drivers on the Samba server:

- The GUI, “*Add Printer Wizard*” *upload-from-a-Windows-client* method.
- The command line, “*smbclient/rpcclient*” *upload-from-a-UNIX-workstation* method.
- The Imprints Toolset method.

These three methods apply to CUPS all the same. A new and more convenient way to load the Windows drivers into Samba is provided if you use CUPS:

- the `cupsaddsmb` utility.

`cupsaddsmb` is discussed in much detail further below. But we first explore the CUPS filtering system and compare the Windows and UNIX printing architectures.

19.4 Advanced Intelligent Printing with PostScript Driver Download

We now know how to set up a “*dump*” printserver, that is, a server which is spooling print-jobs “*raw*”, leaving the print data untouched.

Possibly you need to setup CUPS in a smarter way. The reasons could be manifold:

- Maybe your boss wants to get monthly statistics: Which printer did how many pages? What was the average data size of a job? What was the average print run per day? What are the typical hourly peaks in printing? Which department prints how much?
- Maybe you are asked to setup a print quota system: Users should not be able to print more jobs, once they have surpassed a given limit per period.
- Maybe your previous network printing setup is a mess and must be re-organized from a clean beginning.
- Maybe you have experiencing too many “*blue screens*” originating from poorly debugged printer drivers running in NT “*kernel mode*”?

These goals cannot be achieved by a raw print server. To build a server meeting these requirements, you’ll first need to learn about how CUPS works and how you can enable its features.

What follows is the comparison of some fundamental concepts for Windows and UNIX printing; then follows a description of the CUPS filtering system, how it works and how you can tweak it.

19.4.1 GDI on Windows – PostScript on UNIX

Network printing is one of the most complicated and error-prone day-to-day tasks any user or administrator may encounter. This is true for all OS platforms. And there are reasons for this.

You can’t expect most file formats to just throw them toward printers and they get printed. There needs to be a file format conversion in between. The problem is that there is no common standard for print file formats across all manufacturers and printer types. While PostScript (trademark held by Adobe) and, to an extent, PCL (trademark held by HP) have developed into semi-official “*standards*” by being the most widely used PDLs Page Description Languages (PDLs), there are still many manufacturers who “*roll their own*” (their reasons may be unacceptable license fees for using printer-embedded PostScript interpreters, and so on).

19.4.2 Windows Drivers, GDI and EMF

In Windows OS, the format conversion job is done by the printer drivers. On MS Windows OS platforms all application programmers have at their disposal a built-in API, the Graphical Device Interface (GDI), as part and parcel of the OS itself to base themselves on. This GDI core is used as one common unified ground for all Windows programs to draw pictures,

fonts and documents *on screen* as well as *on paper* (print). Therefore, printer driver developers can standardize on a well-defined GDI output for their own driver input. Achieving WYSIWYG (“*What You See Is What You Get*”) is relatively easy, because the on-screen graphic primitives, as well as the on-paper drawn objects, come from one common source. This source, the GDI, often produces a file format called Enhanced MetaFile (EMF). The EMF is processed by the printer driver and converted to the printer-specific file format.

NOTE



To the GDI foundation in MS Windows, Apple has chosen to put paper and screen output on a common foundation for their (BSD-UNIX-based, did you know?) Mac OS X and Darwin Operating Systems. Their *Core Graphic Engine* uses a *PDF* derivative for all display work.

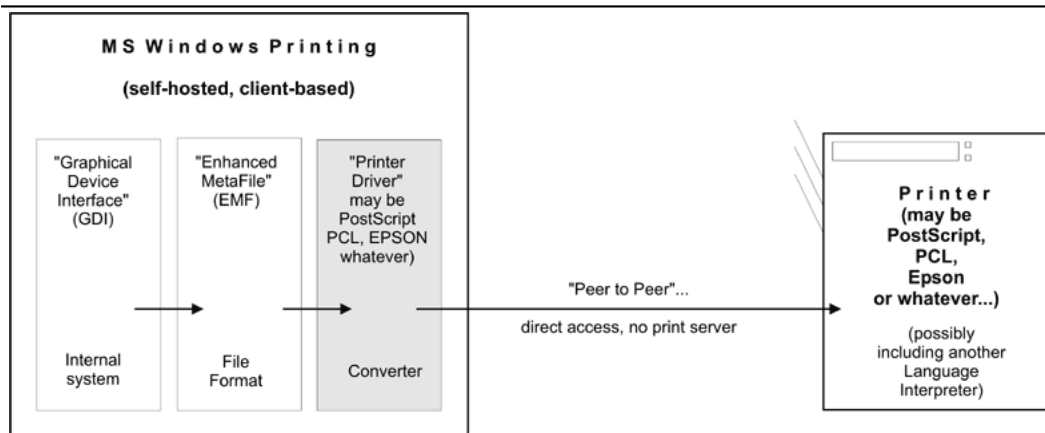

Figure 19.1. Windows printing to a local printer.

19.4.3 UNIX Printfile Conversion and GUI Basics

In UNIX and Linux, there is no comparable layer built into the OS kernel(s) or the X (screen display) server. Every application is responsible for itself to create its print output. Fortunately, most use PostScript and that at least gives some common ground. Unfortunately, there are many different levels of quality for this PostScript. And worse, there is a huge difference (and no common root) in the way the same document is displayed on screen and how it is presented on paper. WYSIWYG is more difficult to achieve. This goes back to the time, decades ago, when the predecessors of X.org, designing the UNIX foundations and protocols for Graphical User Interfaces, refused to take responsibility for “*paper output*” also, as some had demanded at the time, and restricted itself to “*on-screen only*.” (For some years now, the “*Xprint*” project has been under development, attempting to build

printing support into the X framework, including a PostScript and a PCL driver, but it is not yet ready for prime time.) You can see this unfavorable inheritance up to the present day by looking into the various “*font*” directories on your system; there are separate ones for fonts used for X display and fonts to be used on paper.

Background. The PostScript programming language is an “*invention*” by Adobe Inc., but its specifications have been published to the full. Its strength lies in its powerful abilities to describe graphical objects (fonts, shapes, patterns, lines, curves, and dots), their attributes (color, linewidth) and the way to manipulate (scale, distort, rotate, shift) them. Because of its open specification, anybody with the skill can start writing his own implementation of a PostScript interpreter and use it to display PostScript files on screen or on paper. Most graphical output devices are based on the concept of “*raster images*” or “*pixels*” (one notable exception is pen plotters). Of course, you can look at a PostScript file in its textual form and you will be reading its PostScript code, the language instructions which need to be interpreted by a rasterizer. Rasterizers produce pixel images, which may be displayed on screen by a viewer program or on paper by a printer.

19.4.4 PostScript and Ghostscript

So, UNIX is lacking a common ground for printing on paper and displaying on screen. Despite this unfavorable legacy for UNIX, basic printing is fairly easy if you have PostScript printers at your disposal. The reason is these devices have a built-in PostScript language “*interpreter*,” also called a Raster Image Processor (RIP) (which makes them more expensive than other types of printers); throw PostScript toward them, and they will spit out your printed pages. Their RIP is doing all the hard work of converting the PostScript drawing commands into a bitmap picture as you see it on paper, in a resolution as done by your printer. This is no different to PostScript printing a file from a Windows origin.

NOTE



Traditional UNIX programs and printing systems — while using PostScript — are largely not PPD-aware. PPDs are “*PostScript Printer Description*” files. They enable you to specify and control all options a printer supports: duplexing, stapling and punching. Therefore, UNIX users for a long time couldn’t choose many of the supported device and job options, unlike Windows or Apple users. But now there is CUPS.

However, there are other types of printers out there. These do not know how to print PostScript. They use their own Page Description Language (PDL, often proprietary). To print to them is much more demanding. Since your UNIX applications mostly produce PostScript, and since these devices do not understand PostScript, you need to convert the print files to a format suitable for your printer on the host before you can send it away.

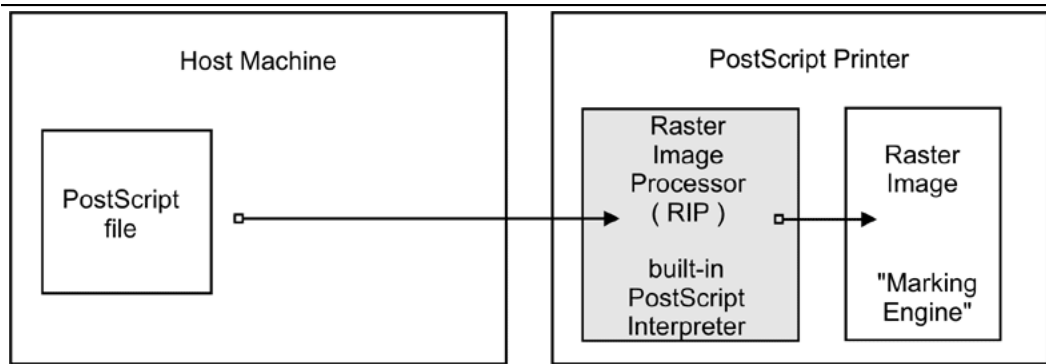

Figure 19.2. Printing to a PostScript printer.

19.4.5 Ghostscript — the Software RIP for Non-PostScript Printers

Here is where Ghostscript kicks in. Ghostscript is the traditional (and quite powerful) PostScript interpreter used on UNIX platforms. It is a RIP in software, capable of doing a *lot* of file format conversions for a very broad spectrum of hardware devices as well as software file formats. Ghostscript technology and drivers are what enable PostScript printing to non-PostScript hardware.

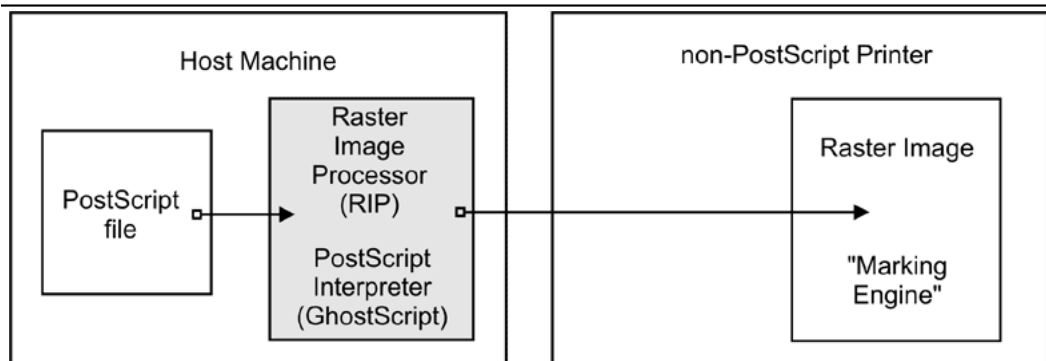

Figure 19.3. Ghostscript as a RIP for non-postscript printers.

TIP



Use the “*gs -h*” command to check for all built-in “*devices*” of your Ghostscript version. If you specify a parameter of `-sDEVICE=png256` on your Ghostscript command line, you are asking Ghostscript to convert the input into a PNG file. Naming a “*device*” on the command line is the most important single parameter to tell Ghostscript exactly how it should render the input. New Ghostscript versions are released at fairly regular intervals, now by artofcode LLC. They are initially put under the “*AFPL*” license, but re-released under the GNU GPL as soon as the next AFPL version appears. GNU Ghostscript is probably the version installed on most Samba systems. But it has some deficiencies. Therefore, ESP Ghostscript was developed as an enhancement over GNU Ghostscript, with lots of bug-fixes, additional devices and improvements. It is jointly maintained by developers from CUPS, Gimp-Print, MandrakeSoft, SuSE, Red Hat, and Debian. It includes the “*cups*” device (essential to print to non-PS printers from CUPS).

19.4.6 PostScript Printer Description (PPD) Specification

While PostScript in essence is a Page Description Language (PDL) to represent the page layout in a device-independent way, real-world print jobs are always ending up being output on hardware with device-specific features. To take care of all the differences in hardware and to allow for innovations, Adobe has specified a syntax and file format for PostScript Printer Description (PPD) files. Every PostScript printer ships with one of these files.

PPDs contain all the information about general and special features of the given printer model: Which different resolutions can it handle? Does it have a Duplexing Unit? How many paper trays are there? What media types and sizes does it take? For each item, it also names the special command string to be sent to the printer (mostly inside the PostScript file) in order to enable it.

Information from these PPDs is meant to be taken into account by the printer drivers. Therefore, installed as part of the Windows PostScript driver for a given printer is the printer’s PPD. Where it makes sense, the PPD features are presented in the drivers’ UI dialogs to display to the user a choice of print options. In the end, the user selections are somehow written (in the form of special PostScript, PJJ, JCL or vendor-dependent commands) into the PostScript file created by the driver.

WARNING

A PostScript file that was created to contain device-specific commands for achieving a certain print job output (e.g., duplex-ed, stapled and punched) on a specific target machine, may not print as expected, or may not be printable at all on other models; it also may not be fit for further processing by software (e.g., by a PDF distilling program).

19.4.7 Using Windows-Formatted Vendor PPDs

CUPS can handle all spec-compliant PPDs as supplied by the manufacturers for their PostScript models. Even if a vendor might not have mentioned our favorite OS in his manuals and brochures, you can safely trust this: *If you get the Windows NT version of the PPD, you can use it unchanged in CUPS* and thus access the full power of your printer just like a Windows NT user could!

TIP

To check the spec compliance of any PPD online, go to <http://www.cups.org/testppd.php> and upload your PPD. You will see the results displayed immediately. CUPS in all versions after 1.1.19 has a much more strict internal PPD parsing and checking code enabled; in case of printing trouble, this online resource should be one of your first pit-stops.

WARNING

For real PostScript printers, *do not* use the *Foomatic* or *cupsomatic* PPDs from [Linuxprinting.org](http://linuxprinting.org). With these devices, the original vendor-provided PPDs are always the first choice!

TIP



If you are looking for an original vendor-provided PPD of a specific device, and you know that an NT4 box (or any other Windows box) on your LAN has the PostScript driver installed, just use **smbclient //NT4-box/print/\$ -U username** to access the Windows directory where all printer driver files are stored. First look in the W32X86/2 subdir for the PPD you are seeking.

19.4.8 CUPS Also Uses PPDs for Non-PostScript Printers

CUPS also uses specially crafted PPDs to handle non-PostScript printers. These PPDs are usually not available from the vendors (and no, you can't just take the PPD of a PostScript printer with the same model name and hope it works for the non-PostScript version too). To understand how these PPDs work for non-PS printers, we first need to dive deeply into the CUPS filtering and file format conversion architecture. Stay tuned.

19.5 The CUPS Filtering Architecture

The core of the CUPS filtering system is based on Ghostscript. In addition to Ghostscript, CUPS uses some other filters of its own. You (or your OS vendor) may have plugged in even more filters. CUPS handles all data file formats under the label of various MIME types. Every incoming printfile is subjected to an initial auto-typing. The auto-typing determines its given MIME type. A given MIME type implies zero or more possible filtering chains relevant to the selected target printer. This section discusses how MIME types recognition and conversion rules interact. They are used by CUPS to automatically setup a working filtering chain for any given input data format.

If CUPS rasterizes a PostScript file natively to a bitmap, this is done in two stages:

- The first stage uses a Ghostscript device named “*cups*” (this is since version 1.1.15) and produces a generic raster format called “*CUPS raster*”.
- The second stage uses a “*raster driver*” that converts the generic CUPS raster to a device-specific raster.

Make sure your Ghostscript version has the “*cups*” device compiled in (check with **gs -h | grep cups**). Otherwise you may encounter the dreaded **Unable to convert file 0** in your CUPS error_log file. To have “*cups*” as a device in your Ghostscript, you either need to patch GNU Ghostscript and re-compile, or use ESP Ghostscript <<http://www.cups.org/ghostscript.php>>. The superior alternative is ESP Ghostscript. It supports not just CUPS, but 300 other devices too (while GNU Ghostscript supports only about 180). Because of this broad output device support, ESP Ghostscript is the first choice for non-CUPS spoolers, too. It is now recommended by Linuxprinting.org for all spoolers.

CUPS printers may be setup to use external rendering paths. One of the most common is provided by the Foomatic/cupsomatic concept from Linuxprinting.org. <<http://www.cups.org/foomatic>>

linuxprinting.org/> This uses the classical Ghostscript approach, doing everything in one step. It does not use the “*cups*” device, but one of the many others. However, even for Foomatic/cupsomatic usage, best results and broadest printer model support is provided by ESP Ghostscript (more about cupsomatic/Foomatic, particularly the new version called now *foomatic-rip*, follows below).

19.5.1 MIME Types and CUPS Filters

CUPS reads the file `/etc/cups/mime.types` (and all other files carrying a `*.types` suffix in the same directory) upon startup. These files contain the MIME type recognition rules that are applied when CUPS runs its auto-typing routines. The rule syntax is explained in the man page for `mime.types` and in the comments section of the `mime.types` file itself. A simple rule reads like this:

```
application/pdf          pdf string(0,%PDF)
```

This means if a filename has either a `.pdf` suffix or if the magic string `%PDF` is right at the beginning of the file itself (offset 0 from the start), then it is a PDF file (*application/pdf*). Another rule is this:

```
application/postscript  ai eps ps string(0,%!) string(0,<04>%!)
```

If the filename has one of the suffixes `.ai`, `.eps`, `.ps` or if the file itself starts with one of the strings `%!` or `<04>%!`, it is a generic PostScript file (*application/postscript*).

WARNING

Don't confuse the other `mime.types` files your system might be using with the one in the `/etc/cups/` directory.

NOTE



There is an important difference between two similar MIME types in CUPS: one is *application/postscript*, the other is *application/vnd.cups-postscript*. While *application/postscript* is meant to be device independent (job options for the file are still outside the PS file content, embedded in command line or environment variables by CUPS), *application/vnd.cups-postscript* may have the job options inserted into the PostScript data itself (where applicable). The transformation of the generic PostScript (*application/postscript*) to the device-specific version (*application/vnd.cups-postscript*) is the responsibility of the CUPS *pstops* filter. *pstops* uses information contained in the PPD to do the transformation.

CUPS can handle ASCII text, HP-GL, PDF, PostScript, DVI, and many image formats (GIF, PNG, TIFF, JPEG, Photo-CD, SUN-Raster, PNM, PBM, SGI-RGB, and more) and their associated MIME types with its filters.

19.5.2 MIME Type Conversion Rules

CUPS reads the file `/etc/cups/mime.convs` (and all other files named with a `*.convs` suffix in the same directory) upon startup. These files contain lines naming an input MIME type, an output MIME type, a format conversion filter that can produce the output from the input type and virtual costs associated with this conversion. One example line reads like this:

```
application/pdf          application/postscript  33  pdftops
```

This means that the *pdftops* filter will take *application/pdf* as input and produce *application/postscript* as output; the virtual cost of this operation is 33 CUPS-\$. The next filter is more expensive, costing 66 CUPS-:

```
application/vnd.hp-HPGL application/postscript  66  hpgltops
```

This is the *hpgltops*, which processes HP-GL plotter files to PostScript.

```
application/octet-stream
```

Here are two more examples:

```
application/x-shell      application/postscript  33  texttops
```

text/plain application/postscript 33 texttops

The last two examples name the *texttops* filter to work on *text/plain* as well as on *application/x-shell*. (Hint: This differentiation is needed for the syntax highlighting feature of *texttops*).

19.5.3 Filtering Overview

There are many more combinations named in `mime.convs`. However, you are not limited to use the ones pre-defined there. You can plug in any filter you like into the CUPS framework. It must meet, or must be made to meet, some minimal requirements. If you find (or write) a cool conversion filter of some kind, make sure it complies to what CUPS needs and put in the right lines in `mime.types` and `mime.convs`, then it will work seamlessly inside CUPS.

19.5.3.1 Filter requirements

The mentioned “*CUPS requirements*” for filters are simple. Take filenames or `stdin` as input and write to `stdout`. They should take these 5 or 6 arguments: *printer job user title copies options [filename]*

Printer The name of the printer queue (normally this is the name of the filter being run).

job The numeric job ID for the job being printed.

user The string from the originating-user-name attribute.

title The string from the job-name attribute.

copies The numeric value from the number-copies attribute.

options The job options.

filename (Optionally) The print request file (if missing, filters expected data fed through `stdin`). In most cases, it is easy to write a simple wrapper script around existing filters to make them work with CUPS.

19.5.4 Prefilters

As previously stated, PostScript is the central file format to any UNIX-based printing system. From PostScript, CUPS generates raster data to feed non-PostScript printers.

But what happens if you send one of the supported non-PS formats to print? Then CUPS runs “*pre-filters*” on these input formats to generate PostScript first. There are pre-filters

to create PS from ASCII text, PDF, DVI, or HP-GL. The outcome of these filters is always of MIME type *application/postscript* (meaning that any device-specific print options are not yet embedded into the PostScript by CUPS, and that the next filter to be called is *pstops*). Another pre-filter is running on all supported image formats, the *imagetops* filter. Its outcome is always of MIME type *application/vnd.cups-postscript* (not *application/postscript*), meaning it has the print options already embedded into the file.

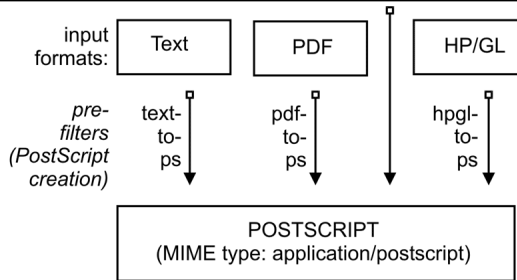

Figure 19.4. Pre-filtering in CUPS to form PostScript.

19.5.5 pstops

pstops is the filter to convert *application/postscript* to *application/vnd.cups-postscript*. It was said above that this filter inserts all device-specific print options (commands to the printer to ask for the duplexing of output, or stapling and punching it, and so on) into the PostScript file.

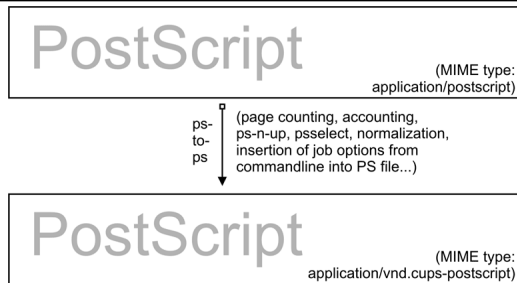

Figure 19.5. Adding device-specific print options.

This is not all. Other tasks performed by it are:

- Selecting the range of pages to be printed (if you choose to print only pages “3, 6, 8-11, 16, 19-21”, or only the odd numbered ones).
- Putting 2 or more logical pages on one sheet of paper (the so-called “*number-up*” function).
- Counting the pages of the job to insert the accounting information into the `/var/log/cups/page_log`.

19.5.6 pstoraster

pstoraster is at the core of the CUPS filtering system. It is responsible for the first stage of the rasterization process. Its input is of MIME type `application/vnd.cups-postscript`; its output is `application/vnd.cups-raster`. This output format is not yet meant to be printable. Its aim is to serve as a general purpose input format for more specialized *raster drivers* that are able to generate device-specific printer data.

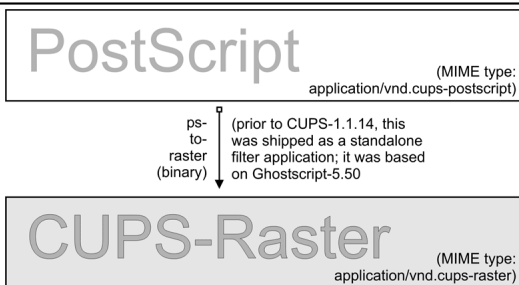

Figure 19.6. PostScript to intermediate raster format.

CUPS raster is a generic raster format with powerful features. It is able to include per-page information, color profiles, and more, to be used by the following downstream raster drivers. Its MIME type is registered with IANA and its specification is, of course, completely open. It is designed to make it quite easy and inexpensive for manufacturers to develop Linux and UNIX raster drivers for their printer models, should they choose to do so. CUPS always takes care for the first stage of rasterization so these vendors do not need to care about Ghostscript complications (in fact, there is currently more than one vendor financing the development of CUPS raster drivers).

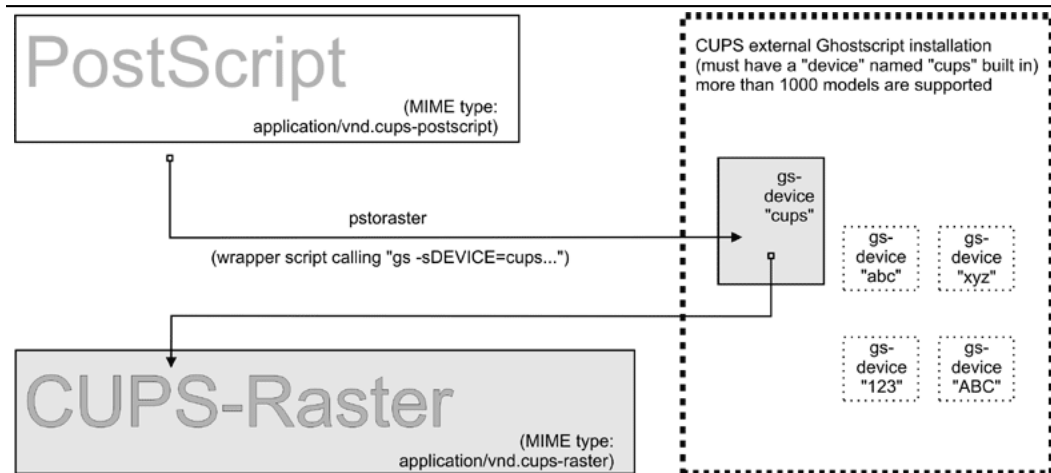

Figure 19.7. CUPS-raster production using Ghostscript.

CUPS versions before version 1.1.15 were shipping a binary (or source code) standalone

filter, named *pstoraster*. *pstoraster* was derived from GNU Ghostscript 5.50, and could be installed besides and in addition to any GNU or AFPL Ghostscript package without conflicting.

>From version 1.1.15, this has changed. The functions for this have been integrated back into Ghostscript (now based on GNU Ghostscript version 7.05). The *pstoraster* filter is now a simple shell script calling **gs** with the **-sDEVICE=cups** parameter. If your Ghostscript does not show a success on asking for **gs -h |grep cups**, you might not be able to print. Update your Ghostscript.

19.5.7 imagetops and imageraster

In the section about pre-filters, we mentioned the pre-filter that generates PostScript from image formats. The *imageraster* filter is used to convert directly from image to raster, without the intermediate PostScript stage. It is used more often than the above mentioned pre-filters. We summarize flowchart of image file filtering on next picture.

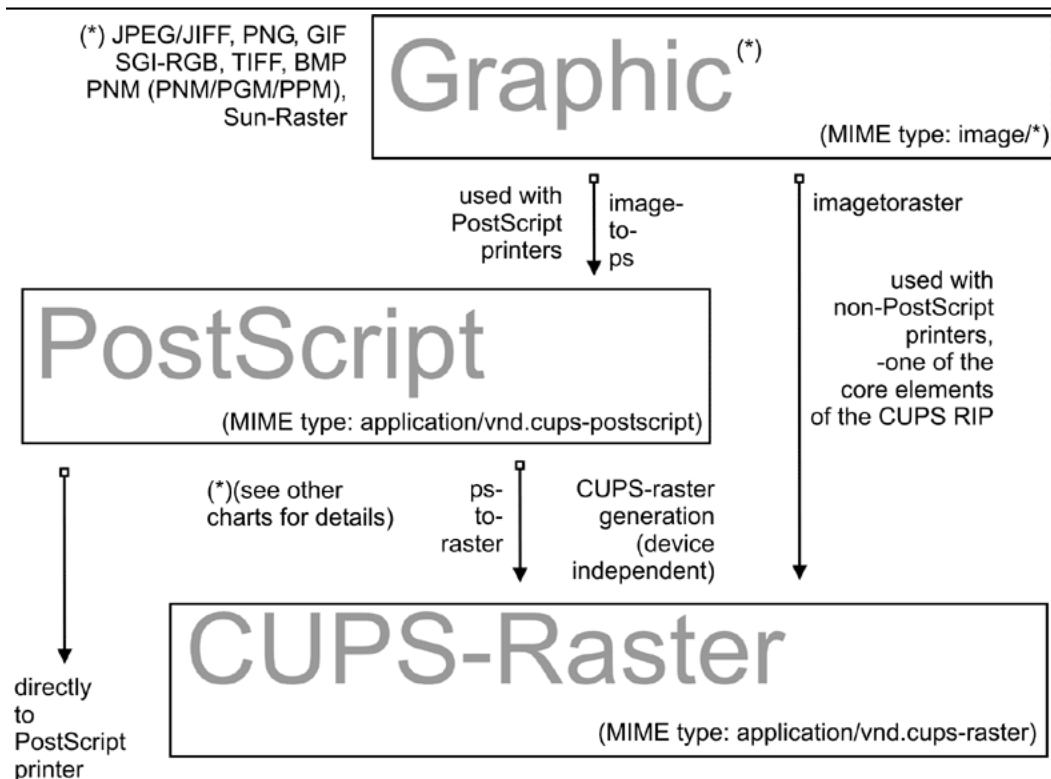

Figure 19.8. Image format to CUPS-raster format conversion.

19.5.8 rasterto [printers specific]

CUPS ships with quite different raster drivers processing CUPS raster. On my system I find in `/usr/lib/cups/filter/` these: *rastertoalps*, *rastertobj*, *rastertoepson*, *rastertoescp*, *rastertopcl*, *rastertoturboprint*, *rastertoapdk*, *rastertodymo*, *rastertoescp*, *raster-tohp*, and *rastertoprinter*. Don't worry if you have less than this; some of these are installed by commercial add-ons to CUPS (like *rastertoturboprint*), others (like *rastertoprinter*) by third-party driver development projects (such as Gimp-Print) wanting to cooperate as closely as possible with CUPS.

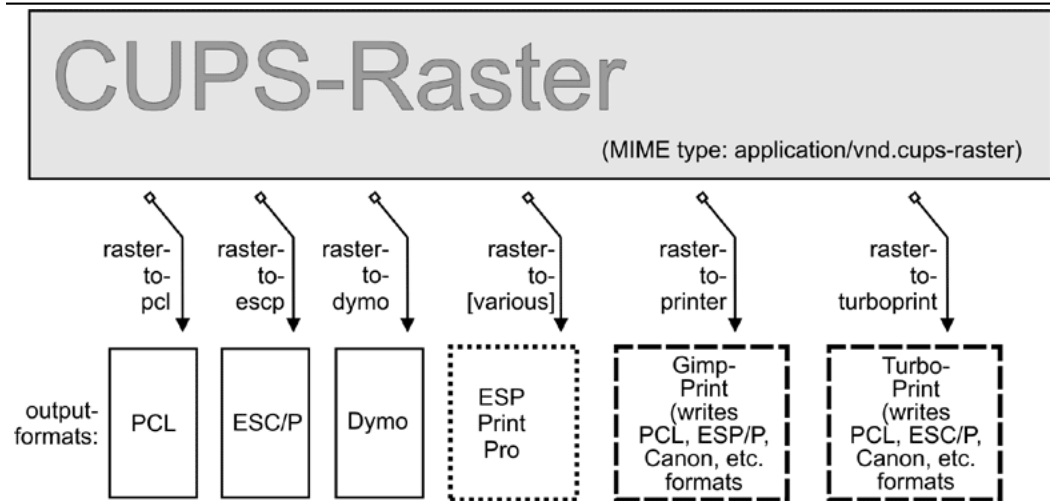

Figure 19.9. Raster to printer-specific formats.

19.5.9 CUPS Backends

The last part of any CUPS filtering chain is a backend. Backends are special programs that send the print-ready file to the final device. There is a separate backend program for any transfer protocol of sending print jobs over the network, or for every local interface. Every CUPS print queue needs to have a CUPS “*device-URI*” associated with it. The device URI is the way to encode the backend used to send the job to its destination. Network device-URIs are using two slashes in their syntax, local device URIs only one, as you can see from the following list. Keep in mind that local interface names may vary much from my examples, if your OS is not Linux:

usb This backend sends print files to USB-connected printers. An example for the CUPS device-URI to use is: `usb:/dev/usb/lp0`.

serial This backend sends print files to serially connected printers. An example for the CUPS device-URI to use is: `serial:/dev/ttyS0?baud=11500`.

parallel This backend sends print files to printers connected to the parallel port. An example for the CUPS device-URI to use is: `parallel:/dev/lp0`.

SCSI This backend sends print files to printers attached to the SCSI interface. An example for the CUPS device-URI to use is: `scsi:/dev/sr1`.

lpd This backend sends print files to LPR/LPD connected network printers. An example for the CUPS device-URI to use is: `lpd://remote_host_name/remote_queue_name`.

AppSocket/HP JetDirect This backend sends print files to AppSocket (a.k.a. "HP Jet-Direct") connected network printers. An example for the CUPS device-URI to use is: `socket://10.11.12.13:9100`.

ipp This backend sends print files to IPP connected network printers (or to other CUPS servers). Examples for CUPS device-URIs to use are: `ipp://192.193.194.195/ipp` (for many HP printers) or `ipp://remote_cups_server/printers/remote_printer_name`.

http This backend sends print files to HTTP connected printers. (The `http://` CUPS backend is only a symlink to the `ipp://` backend.) Examples for the CUPS device-URIs to use are: `http://192.193.194.195:631/ipp` (for many HP printers) or `http://remote_cups_server:631/printers/remote_printer_name`.

smb This backend sends print files to printers shared by a Windows host. An example for CUPS device-URIs that may be used includes:

```
smb://workgroup/server/printerssharename
smb://server/printerssharename
smb://username:password@workgroup/server/printerssharename
smb://username:password@server/printerssharename
```

The `smb://` backend is a symlink to the Samba utility `smbspool` (does not ship with CUPS). If the symlink is not present in your CUPS backend directory, have your root user create it: `ln -s 'which smbpool' /usr/lib/cups/backend/smb`.

It is easy to write your own backends as shell or Perl scripts, if you need any modification or extension to the CUPS print system. One reason could be that you want to create "special" printers that send the print-jobs as email (through a "mailto:/" backend), convert them to PDF (through a "pdfgen:/" backend) or dump them to "/dev/null". (In fact I have the system-wide default printer set up to be connected to a `devnull:/` backend: there are just too many people sending jobs without specifying a printer, or scripts and programs which do not name a printer. The system-wide default deletes the job and sends a polite email back to the \$USER asking him to always specify the correct printer name.)

Not all of the mentioned backends may be present on your system or usable (depending on your hardware configuration). One test for all available CUPS backends is provided by the `lpinfo` utility. Used with the `-v` parameter, it lists all available backends:

```
$ lpinfo -v
```

19.5.10 The Role of *cupsomatic*/*foomatic*

cupsomatic filters may be the most widely used on CUPS installations. You must be clear about the fact that these were not developed by the CUPS people. They are a third party add-on to CUPS. They utilize the traditional Ghostscript devices to render jobs for CUPS. When troubleshooting, you should know about the difference. Here the whole rendering process is done in one stage, inside Ghostscript, using an appropriate device for the target printer. *cupsomatic* uses PPDs that are generated from the Foomatic Printer & Driver Database at Linuxprinting.org.

You can recognize these PPDs from the line calling the *cupsomatic* filter:

```
*cupsFilter: "application/vnd.cups-postscript 0 cupsomatic"
```

You may find this line among the first 40 or so lines of the PPD file. If you have such a PPD installed, the printer shows up in the CUPS Web interface with a *foomatic* namepart for the driver description. *cupsomatic* is a Perl script that runs Ghostscript with all the complicated command line options auto-constructed from the selected PPD and command line options give to the print-job.

However, *cupsomatic* is now deprecated. Its PPDs (especially the first generation of them, still in heavy use out there) are not meeting the Adobe specifications. You might also suffer difficulties when you try to download them with “*Point’n’Print*” to Windows clients. A better and more powerful successor is now in a stable beta-version: it is called *foomatic-rip*. To use *foomatic-rip* as a filter with CUPS, you need the new-type PPDs. These have a similar but different line:

```
*cupsFilter: "application/vnd.cups-postscript 0 foomatic-rip"
```

The PPD generating engine at Linuxprinting.org has been revamped. The new PPDs comply to the Adobe spec. On top, they also provide a new way to specify different quality levels (hi-res photo, normal color, grayscale, and draft) with a single click, whereas before you could have required five or more different selections (media type, resolution, inktype and dithering algorithm). There is support for custom-size media built in. There is support to switch print-options from page to page in the middle of a job. And the best thing is the new *foomatic-rip* now works seamlessly with all legacy spoolers too (like LPRng, BSD-LPD, PDQ, PPR and so on), providing for them access to use PPDs for their printing.

19.5.11 The Complete Picture

If you want to see an overview of all the filters and how they relate to each other, the complete picture of the puzzle is at the end of this document.

19.5.12 mime.convs

CUPS auto-constructs all possible filtering chain paths for any given MIME type, and every printer installed. But how does it decide in favor or against a specific alternative? (There may often be cases where there is a choice of two or more possible filtering chains for the same target printer.) Simple. You may have noticed the figures in the third column of the `mime.convs` file. They represent virtual costs assigned to this filter. Every possible filtering chain will sum up to a total “*filter cost*.” CUPS decides for the most “*inexpensive*” route.

TIP



The setting of `FilterLimit 1000` in `cupsd.conf` will not allow more filters to run concurrently than will consume a total of 1000 virtual filter cost. This is an efficient way to limit the load of any CUPS server by setting an appropriate “*FilterLimit*” value. A `FilterLimit` of 200 allows roughly one job at a time, while a `FilterLimit` of 1000 allows approximately five jobs maximum at a time.

19.5.13 “Raw” Printing

You can tell CUPS to print (nearly) any file “*raw*”. “*Raw*” means it will not be filtered. CUPS will send the file to the printer “*as is*” without bothering if the printer is able to digest it. Users need to take care themselves that they send sensible data formats only. Raw printing can happen on any queue if the “`-o raw`” option is specified on the command line. You can also set up raw-only queues by simply not associating any PPD with it. This command:

```
$ lpadmin -P rawprinter -v socket://11.12.13.14:9100 -E
```

sets up a queue named “*rawprinter*”, connected via the “*socket*” protocol (a.k.a. “*HP JetDirect*”) to the device at IP address 11.12.13.14, using port 9100. (If you had added a PPD with `-P /path/to/PPD` to this command line, you would have installed a “*normal*” print queue.

CUPS will automatically treat each job sent to a queue as a “*raw*” one, if it can’t find a PPD associated with the queue. However, CUPS will only send known MIME types (as defined in its own `mime.types` file) and refuse others.

19.5.14 application/octet-stream Printing

Any MIME type with no rule in the `/etc/cups/mime.types` file is regarded as unknown or `application/octet-stream` and will not be sent. Because CUPS refuses to print unknown

MIME types per default, you will probably have experienced the fact that print jobs originating from Windows clients were not printed. You may have found an error message in your CUPS logs like:

```
Unable to convert file 0 to printable format for job
```

To enable the printing of *application/octet-stream* files, edit these two files:

- `/etc/cups/mime.convs`
- `/etc/cups/mime.types`

Both contain entries (at the end of the respective files) which must be uncommented to allow RAW mode operation for *application/octet-stream*. In `/etc/cups/mime.types` make sure this line is present:

```
application/octet-stream
```

This line (with no specific auto-typing rule set) makes all files not otherwise auto-typed a member of *application/octet-stream*. In `/etc/cups/mime.convs`, have this line:

```
application/octet-stream  application/vnd.cups-raw  0  -
```

This line tells CUPS to use the *Null Filter* (denoted as “-”, doing nothing at all) on *application/octet-stream*, and tag the result as *application/vnd.cups-raw*. This last one is always a green light to the CUPS scheduler to now hand the file over to the backend connecting to the printer and sending it over.

NOTE



Editing the `mime.convs` and the `mime.types` file does not *enforce* “raw” printing, it only *allows* it.

Background. CUPS being a more security-aware printing system than traditional ones does not by default allow one to send deliberate (possibly binary) data to printing devices. (This could be easily abused to launch a Denial of Service attack on your printer(s), causing at least the loss of a lot of paper and ink...) “*Unknown*” data are regarded by CUPS as *MIME type application/octet-stream*. While you *can* send data “raw”, the MIME type for these must be one that is known to CUPS and an allowed one. The file `/etc/cups/mime.types` defines the “*rules*” of how CUPS recognizes MIME types. The file `/etc/cups/mime.convs` decides which file conversion filter(s) may be applied to which MIME types.

19.5.15 PostScript Printer Descriptions (PPDs) for Non-PS Printers

Originally PPDs were meant to be used for PostScript printers only. Here, they help to send device-specific commands and settings to the RIP which processes the job file. CUPS has extended this scope for PPDs to cover non-PostScript printers too. This was not difficult, because it is a standardized file format. In a way it was logical too: CUPS handles PostScript and uses a PostScript RIP (Ghostscript) to process the job files. The only difference is: a PostScript printer has the RIP built-in, for other types of printers the Ghostscript RIP runs on the host computer.

PPDs for a non-PS printer have a few lines that are unique to CUPS. The most important one looks similar to this:

```
*cupsFilter: application/vnd.cups-raster 66 rastertoprinter
```

It is the last piece in the CUPS filtering puzzle. This line tells the CUPS daemon to use as a last filter *rastertoprinter*. This filter should be served as input an *application/vnd.cups-raster* MIME type file. Therefore, CUPS should auto-construct a filtering chain, which delivers as its last output the specified MIME type. This is then taken as input to the specified *rastertoprinter* filter. After this the last filter has done its work (*rastertoprinter* is a Gimp-Print filter), the file should go to the backend, which sends it to the output device.

CUPS by default ships only a few generic PPDs, but they are good for several hundred printer models. You may not be able to control different paper trays, or you may get larger margins than your specific model supports. See PPDs shipped with CUPS for summary information.

Table 19.1. PPDs shipped with CUPS

PPD file	Printer type
deskjet.ppd	older HP inkjet printers and compatible
deskjet2.ppd	newer HP inkjet printers and compatible
dymo.ppd	label printers
epson9.ppd	Epson 24pin impact printers and compatible
epson24.ppd	Epson 24pin impact printers and compatible
okidata9.ppd	Okidata 9pin impact printers and compatible
okidat24.ppd	Okidata 24pin impact printers and compatible
stcolor.ppd	older Epson Stylus Color printers
stcolor2.ppd	newer Epson Stylus Color printers
stphoto.ppd	older Epson Stylus Photo printers
stphoto2.ppd	newer Epson Stylus Photo printers
laserjet.ppd	all PCL printers. Further below is a discussion of several other driver/PPD-packages suitable for use with CUPS.

19.5.16 *cupsomatic/foomatic-rip* Versus *native CUPS* Printing

Native CUPS rasterization works in two steps:

- First is the *pstoraster* step. It uses the special CUPS device from ESP Ghostscript 7.05.x as its tool.
- Second comes the *rasterdriver* step. It uses various device-specific filters; there are several vendors who provide good quality filters for this step. Some are free software, some are shareware/non-free and some are proprietary.

Often this produces better quality (and has several more advantages) than other methods.

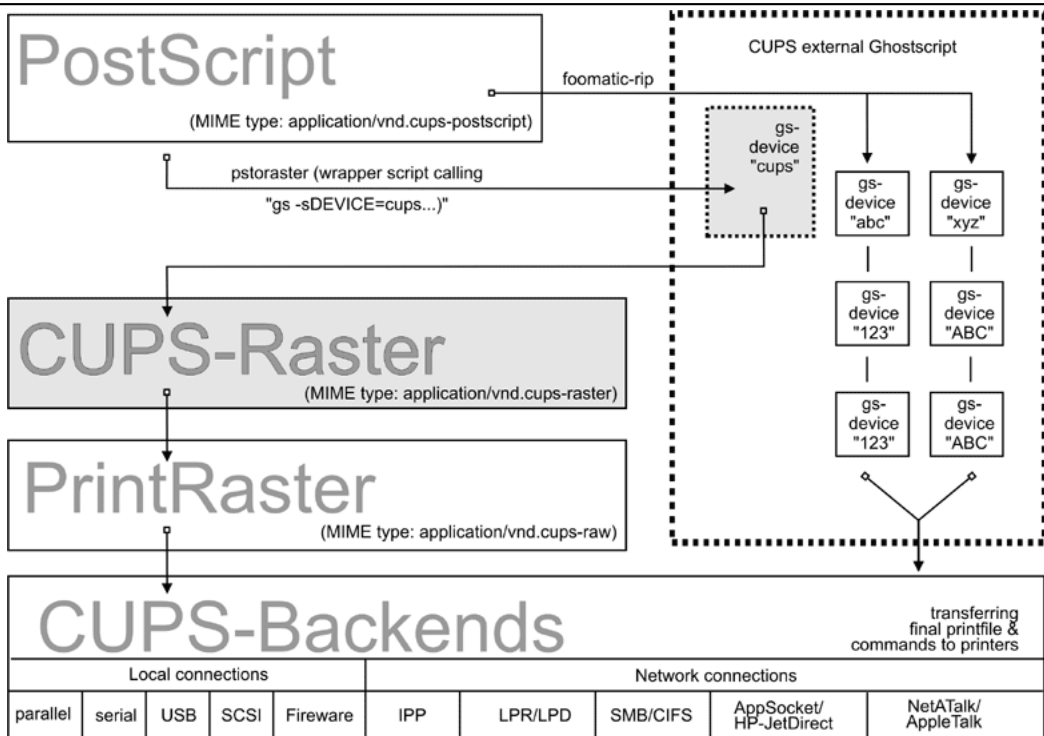

Figure 19.10. *cupsomatic/foomatic* Processing versus Native CUPS.

One other method is the *cupsomatic/foomatic-rip* way. Note that *cupsomatic* is *not* made by the CUPS developers. It is an independent contribution to printing development, made by people from Linuxprinting.org¹. *cupsomatic* is no longer developed and maintained and is no longer supported. It has now been replaced by *foomatic-rip*. *foomatic-rip* is a complete re-write of the old *cupsomatic* idea, but very much improved and generalized to other (non-CUPS) spoolers. An upgrade to *foomatic-rip* is strongly advised, especially if you are upgrading to a recent version of CUPS, too.

Both the *cupsomatic* (old) and the *foomatic-rip* (new) methods from Linuxprinting.org use the traditional Ghostscript print file processing, doing everything in a single step. It

¹see also <<http://www.cups.org/cups-help.html>>

therefore relies on all the other devices built into Ghostscript. The quality is as good (or bad) as Ghostscript rendering is in other spoolers. The advantage is that this method supports many printer models not supported (yet) by the more modern CUPS method.

Of course, you can use both methods side by side on one system (and even for one printer, if you set up different queues) and find out which works best for you.

cupsomatic kidnaps the printfile after the *application/vnd.cups-postscript* stage and deviates it through the CUPS-external, system-wide Ghostscript installation. Therefore the printfile bypasses the *pstoraster* filter (and also bypasses the CUPS-raster-drivers *rastertosomething*). After Ghostscript finished its rasterization, *cupsomatic* hands the rendered file directly to the CUPS backend. The flowchart in *cupsomatic/foomatic* processing versus Native CUPS illustrates the difference between native CUPS rendering and the *Foomatic/cupsomatic* method.

19.5.17 Examples for Filtering Chains

Here are a few examples of commonly occurring filtering chains to illustrate the workings of CUPS.

Assume you want to print a PDF file to an HP JetDirect-connected PostScript printer, but you want to print the pages 3-5, 7, 11-13 only, and you want to print them “two-up” and “duplex”:

- Your print options (page selection as required, two-up, duplex) are passed to CUPS on the command line.
- The (complete) PDF file is sent to CUPS and auto-typed as *application/pdf*.
- The file therefore must first pass the *pdftops* pre-filter, which produces PostScript MIME type *application/postscript* (a preview here would still show all pages of the original PDF).
- The file then passes the *pstops* filter that applies the command line options: it selects the pages 2-5, 7 and 11-13, creates an imposed layout “2 pages on 1 sheet” and inserts the correct “duplex” command (as defined in the printer’s PPD) into the new PostScript file; the file is now of PostScript MIME type *application/vnd.cups-postscript*.
- The file goes to the *socket* backend, which transfers the job to the printers.

The resulting filter chain, therefore, is as drawn in PDF to socket chain.

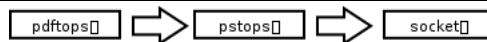

Figure 19.11. PDF to socket chain.

Assume you want to print the same filter to an USB-connected Epson Stylus Photo printer installed with the CUPS *stphoto2.ppd*. The first few filtering stages are nearly the same:

- Your print options (page selection as required, two-up, duplex) are passed to CUPS on the command-line.

- The (complete) PDF file is sent to CUPS and auto-typed as *application/pdf*.
- The file must first pass the *pdftops* pre-filter, which produces PostScript MIME type *application/postscript* (a preview here would still show all pages of the original PDF).
- The file then passes the “*pstops*” filter that applies the command-line options: it selects the pages 2-5, 7 and 11-13, creates an imposed layout “*two pages on one sheet*” and inserts the correct “*duplex*” command... (Oops — this printer and PPD do not support duplex printing at all — so this option will be ignored) into the new PostScript file; the file is now of PostScript MIME type *application/vnd.cups-postscript*.
- The file then passes the *pstoraster* stage and becomes MIME type *application/cups-raster*.
- Finally, the *rastertoepson* filter does its work (as indicated in the printer’s PPD), creating the printer-specific raster data and embedding any user-selected print-options into the print data stream.
- The file goes to the *usb* backend, which transfers the job to the printers.

The resulting filter chain therefore is as drawn in this figure.

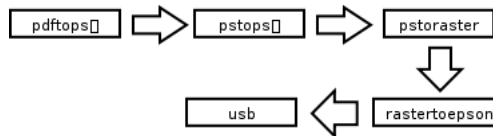

Figure 19.12. PDF to USB chain.

19.5.18 Sources of CUPS Drivers/PPDs

On the Internet you can now find many thousands of CUPS-PPD files (with their companion filters), in many national languages supporting more than thousand non-PostScript models.

- ESP PrintPro <<http://www1.easysw.com/printpro/>> (commercial, non-free) is packaged with more than three thousand PPDs, ready for successful use “*out of the box*” on Linux, Mac OS X, IBM-AIX, HP-UX, Sun-Solaris, SGI-IRIX, Compaq Tru64, Digital UNIX, and some more commercial Unices (it is written by the CUPS developers themselves and its sales help finance the further development of CUPS, as they feed their creators).
- The Gimp-Print-Project <<http://gimp-print.sourceforge.net/>> (GPL, free software) provides around 140 PPDs (supporting nearly 400 printers, many driven to photo quality output), to be used alongside the Gimp-Print CUPS filters.
- TurboPrint <<http://www.turboprint.com/>> (shareware, non-free) supports roughly the same amount of printers in excellent quality.
- OMNI <<http://www-124.ibm.com/developerworks/oss/linux/projects/omni/>> (LPGL, free) is a package made by IBM, now containing support for more than 400

printers, stemming from the inheritance of IBM OS/2 Know-How ported over to Linux (CUPS support is in a beta-stage at present).

- HPIJS <<http://hpinkjet.sourceforge.net/>> (BSD-style licenses, free) supports around 150 of HP's own printers and is also providing excellent print quality now (currently available only via the Foomatic path).
- Foomatic/cupsomatic <<http://www.linuxprinting.org/>> (LPGL, free) from Linuxprinting.org are providing PPDs for practically every Ghostscript filter known to the world (including Omni, Gimp-Print and HPIJS).

19.5.19 Printing with Interface Scripts

CUPS also supports the usage of “*interface scripts*” as known from System V AT&T printing systems. These are often used for PCL printers, from applications that generate PCL print jobs. Interface scripts are specific to printer models. They have a similar role as PPDs for PostScript printers. Interface scripts may inject the Escape sequences as required into the print data stream, if the user has chosen to select a certain paper tray, or print landscape, or use A3 paper, etc. Interfaces scripts are practically unknown in the Linux realm. On HP-UX platforms they are more often used. You can use any working interface script on CUPS too. Just install the printer with the `-i` option:

```
root# lpadmin -p pclprinter -v socket://11.12.13.14:9100 \  
-i /path/to/interface-script
```

Interface scripts might be the “*unknown animal*” to many. However, with CUPS they provide the easiest way to plug in your own custom-written filtering script or program into one specific print queue (some information about the traditional usage of interface scripts is to be found at <<http://playground.sun.com/printing/documentation/interface.html>>).

19.6 Network Printing (Purely Windows)

Network printing covers a lot of ground. To understand what exactly goes on with Samba when it is printing on behalf of its Windows clients, let's first look at a “*purely Windows*” setup: Windows clients with a Windows NT print server.

19.6.1 From Windows Clients to an NT Print Server

Windows clients printing to an NT-based print server have two options. They may:

- Execute the driver locally and render the GDI output (EMF) into the printer-specific format on their own.
- Send the GDI output (EMF) to the server, where the driver is executed to render the printer specific output.

Both print paths are shown in the flowcharts Print driver execution on the client and Print driver execution on the server.

19.6.2 Driver Execution on the Client

In the first case the print server must spool the file as raw, meaning it shouldn't touch the jobfile and try to convert it in any way. This is what a traditional UNIX-based print server can do too, and at a better performance and more reliably than an NT print server. This is what most Samba administrators probably are familiar with. One advantage of this setup is that this “*spooling-only*” print server may be used even if no driver(s) for UNIX are available it is sufficient to have the Windows client drivers available; and installed on the clients.

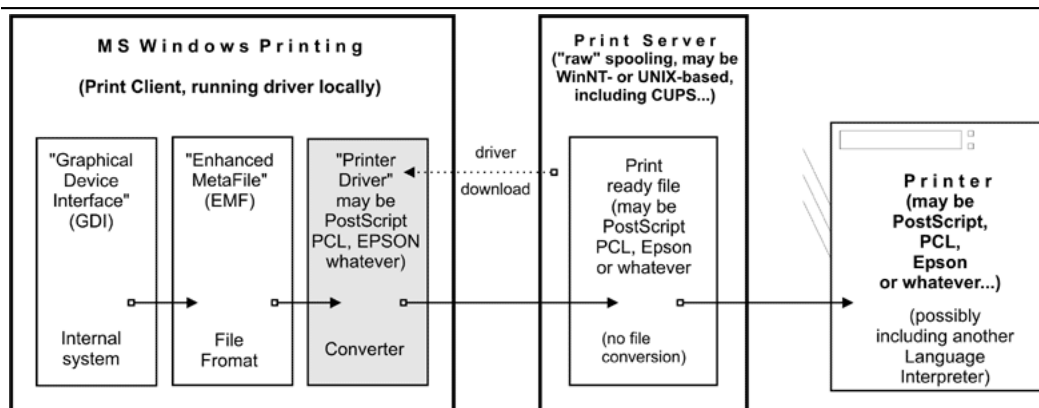

Figure 19.13. Print driver execution on the client.

19.6.3 Driver Execution on the Server

The other path executes the printer driver on the server. The client transfers print files in EMF format to the server. The server uses the PostScript, PCL, ESC/P or other driver to convert the EMF file into the printer-specific language. It is not possible for UNIX to do the same. Currently, there is no program or method to convert a Windows client's GDI output on a UNIX server into something a printer could understand.

However, there is something similar possible with CUPS. Read on.

19.7 Network Printing (Windows Clients — UNIX/Samba Print Servers)

Since UNIX print servers *cannot* execute the Win32 program code on their platform, the picture is somewhat different. However, this does not limit your options all that much. On the contrary, you may have a way here to implement printing features that are not possible otherwise.

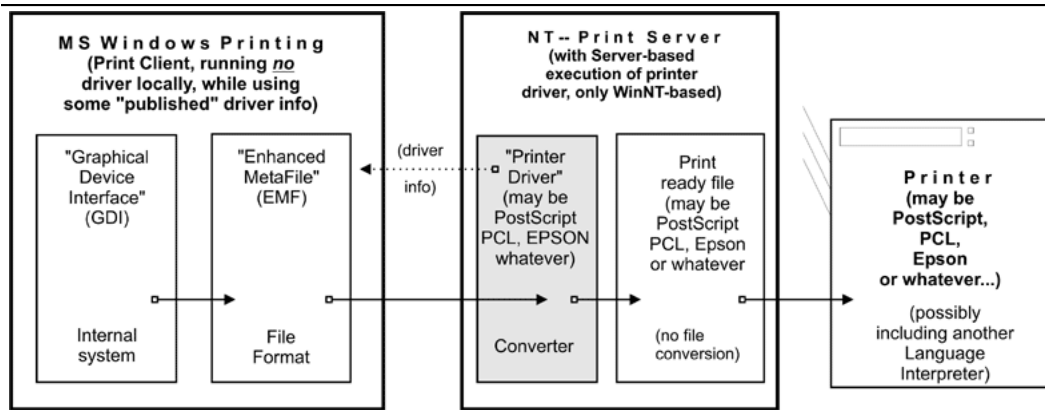

Figure 19.14. Print driver execution on the server.

19.7.1 From Windows Clients to a CUPS/Samba Print Server

Here is a simple recipe showing how you can take advantage of CUPS' powerful features for the benefit of your Windows network printing clients:

- Let the Windows clients send PostScript to the CUPS server.
- Let the CUPS server render the PostScript into device-specific raster format.

This requires the clients to use a PostScript driver (even if the printer is a non-PostScript model). It also requires that you have a driver on the CUPS server.

First, to enable CUPS-based printing through Samba the following options should be set in your `smb.conf` file [global] section:

```
printing = cups
printcap = cups
```

When these parameters are specified, all manually set print directives (like `print` command, or `lppause` command) in `smb.conf` (as well as in Samba itself) will be ignored. Instead, Samba will directly interface with CUPS through its application program interface (API), as long as Samba has been compiled with CUPS library (`libcups`) support. If Samba has not been compiled with CUPS support, and if no other print commands are set up, then printing will use the `System V AT&T` command set, with the `-oraw` option automatically passing through (if you want your own defined print commands to work with a Samba that has CUPS support compiled in, simply use `printing = sysv`).

19.7.2 Samba Receiving Job-files and Passing Them to CUPS

Samba *must* use its own spool directory (it is set by a line similar to `path = /var/spool/samba`, in the `[printers]` or `[printername]` section of `smb.conf`). Samba receives the job in its own spool space and passes it into the spool directory of CUPS (the CUPS spooling directory is set by the `RequestRoot` directive, in a line that defaults to `RequestRoot /var/spool/cups`). CUPS checks the access rights of its spool dir and resets it to healthy

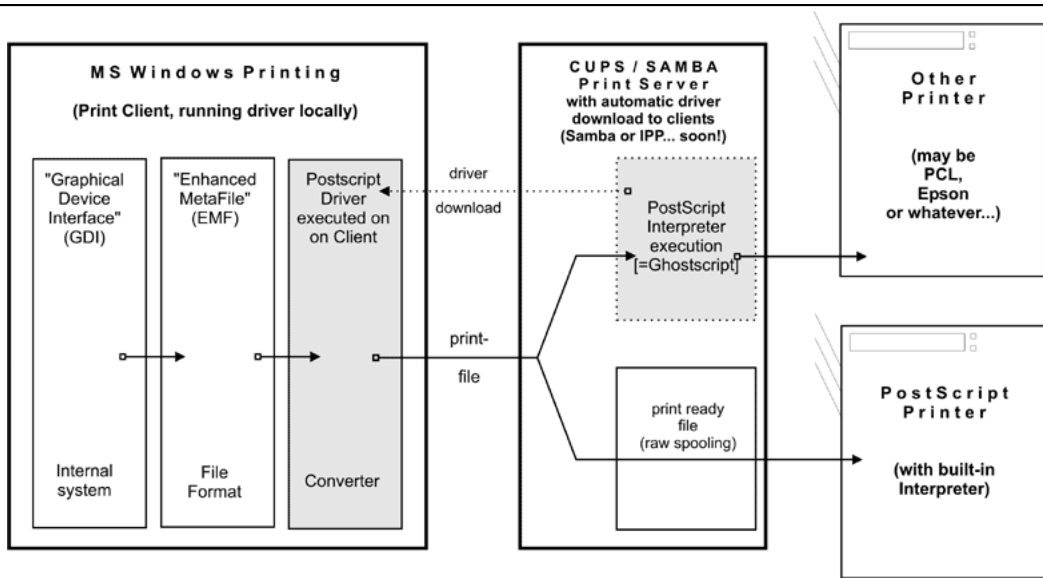

Figure 19.15. Printing via CUPS/Samba server.

values with every restart. We have seen quite a few people who had used a common spooling space for Samba and CUPS, and were struggling for weeks with this “*problem.*”

A Windows user authenticates only to Samba (by whatever means is configured). If Samba runs on the same host as CUPS, you only need to allow “*localhost*” to print. If they run on different machines, you need to make sure the Samba host gets access to printing on CUPS.

19.8 Network PostScript RIP

This section discusses the use of CUPS filters on the server — configuration where clients make use of a PostScript driver with CUPS-PPDs.

PPDs can control all print device options. They are usually provided by the manufacturer, if you own a PostScript printer, that is. PPD files (PostScript Printer Descriptions) are always a component of PostScript printer drivers on MS Windows or Apple Mac OS systems. They are ASCII files containing user-selectable print options, mapped to appropriate PostScript, PCL or PJI commands for the target printer. Printer driver GUI dialogs translate these options “*on-the-fly*” into buttons and drop-down lists for the user to select.

CUPS can load, without any conversions, the PPD file from any Windows (NT is recommended) PostScript driver and handle the options. There is a Web browser interface to the print options (select <http://localhost:631/printers/> and click on one **Configure Printer** button to see it), or a command line interface (see **man lpoptions** or see if you have **lphelp** on your system). There are also some different GUI front-ends on Linux/UNIX, which can present PPD options to users. PPD options are normally meant to be evaluated by the PostScript RIP on the real PostScript printer.

19.8.1 PPDs for Non-PS Printers on UNIX

CUPS does not limit itself to “*real*” PostScript printers in its usage of PPDs. The CUPS developers have extended the scope of the PPD concept to also describe available device and driver options for non-PostScript printers through CUPS-PPDs.

This is logical, as CUPS includes a fully featured PostScript interpreter (RIP). This RIP is based on Ghostscript. It can process all received PostScript (and additionally many other file formats) from clients. All CUPS-PPDs geared to non-PostScript printers contain an additional line, starting with the keyword **cupsFilter*. This line tells the CUPS print system which printer-specific filter to use for the interpretation of the supplied PostScript. Thus CUPS lets all its printers appear as PostScript devices to its clients, because it can act as a PostScript RIP for those printers, processing the received PostScript code into a proper raster print format.

19.8.2 PPDs for Non-PS Printers on Windows

CUPS-PPDs can also be used on Windows-Clients, on top of a “*core*” PostScript driver (now recommended is the “CUPS PostScript Driver for Windows NT/200x/XP”; you can also use the Adobe one, with limitations). This feature enables CUPS to do a few tricks no other spooler can do:

- Act as a networked PostScript RIP (Raster Image Processor), handling print files from all client platforms in a uniform way.
- Act as a central accounting and billing server, since all files are passed through the `pstops` filter and are, therefore, logged in the CUPS `page_log` file. *Note:* this cannot happen with “*raw*” print jobs, which always remain unfiltered per definition.
- Enable clients to consolidate on a single PostScript driver, even for many different target printers.

Using CUPS PPDs on Windows clients enables these to control all print job settings just as a UNIX client can do.

19.9 Windows Terminal Servers (WTS) as CUPS Clients

This setup may be of special interest to people experiencing major problems in WTS environments. WTS often need a multitude of non-PostScript drivers installed to run their clients’ variety of different printer models. This often imposes the price of much increased instability.

19.9.1 Printer Drivers Running in “*Kernel Mode*” Cause Many Problems

In Windows NT printer drivers which run in “*Kernel Mode*”, introduces a high risk for the stability of the system if the driver is not really stable and well-tested. And there are a lot of bad drivers out there! Especially notorious is the example of the PCL printer driver that had an additional sound module running, to notify users via sound-card of their finished

jobs. Do I need to say that this one was also reliably causing “*blue screens of death*” on a regular basis?

PostScript drivers are generally well tested. They are not known to cause any problems, even though they also run in kernel mode. This might be because there have been so far only two different PostScript drivers: the ones from Adobe and the one from Microsoft. Both are well tested and are as stable as you can imagine on Windows. The CUPS driver is derived from the Microsoft one.

19.9.2 Workarounds Impose Heavy Limitations

In many cases, in an attempt to work around this problem, site administrators have resorted to restricting the allowed drivers installed on their WTS to one generic PCL and one PostScript driver. This, however, restricts the clients in the number of printer options available for them. Often they can’t get out more than simplex prints from one standard paper tray, while their devices could do much better, if driven by a different driver!

19.9.3 CUPS: A “*Magical Stone*”?

Using a PostScript driver, enabled with a CUPS-PPD, seems to be a very elegant way to overcome all these shortcomings. There are, depending on the version of Windows OS you use, up to three different PostScript drivers available: Adobe, Microsoft and CUPS PostScript drivers. None of them is known to cause major stability problems on WTS (even if used with many different PPDs). The clients will be able to (again) chose paper trays, duplex printing and other settings. However, there is a certain price for this too: a CUPS server acting as a PostScript RIP for its clients requires more CPU and RAM than when just acting as a “*raw spooling*” device. Plus, this setup is not yet widely tested, although the first feedbacks look very promising.

19.9.4 PostScript Drivers with No Major Problems — Even in Kernel Mode

More recent printer drivers on W200x and XP no longer run in kernel mode (unlike Windows NT). However, both operating systems can still use the NT drivers, running in kernel mode (you can roughly tell which is which as the drivers in subdirectory “*2*” of “*W32X86*” are “*old*” ones). As was said before, the Adobe as well as the Microsoft PostScript drivers are not known to cause any stability problems. The CUPS driver is derived from the Microsoft one. There is a simple reason for this: The MS DDK (Device Development Kit) for Windows NT (which used to be available at no cost to licensees of Visual Studio) includes the source code of the Microsoft driver, and licensees of Visual Studio are allowed to use and modify it for their own driver development efforts. This is what the CUPS people have done. The license does not allow them to publish the whole of the source code. However, they have released the “*diff*” under the GPL, and if you are the owner of an “*MS DDK for Windows NT*,” you can check the driver yourself.

19.10 Configuring CUPS for Driver Download

As we have said before, all previously known methods to prepare client printer drivers on the Samba server for download and Point'n'Print convenience of Windows workstations are working with CUPS, too. These methods were described in the previous chapter. In reality, this is a pure Samba business and only relates to the Samba/Windows client relationship.

19.10.1 *cupsaddsmb*: The Unknown Utility

The **cupsaddsmb** utility (shipped with all current CUPS versions) is an alternate method to transfer printer drivers into the Samba *[print\$]* share. Remember, this share is where clients expect drivers deposited and setup for download and installation. It makes the sharing of any (or all) installed CUPS printers quite easy. **cupsaddsmb** can use the Adobe PostScript driver as well as the newly developed CUPS PostScript Driver for Windows NT/200x/XP. *cupsaddsmb* does *not* work with arbitrary vendor printer drivers, but only with the *exact* driver files that are named in its man page.

The CUPS printer driver is available from the CUPS download site. Its package name is **cups-samba-[version].tar.gz**. It is preferred over the Adobe drivers since it has a number of advantages:

- It supports a much more accurate page accounting.
- It supports banner pages, and page labels on all printers.
- It supports the setting of a number of job IPP attributes (such as job-priority, page-label and job-billing).

However, currently only Windows NT, 2000 and XP are supported by the CUPS drivers. You will also need to get the respective part of Adobe driver if you need to support Windows 95, 98 and ME clients.

19.10.2 Prepare Your **smb.conf** for **cupsaddsmb**

Prior to running **cupsaddsmb**, you need the settings in **smb.conf** as shown in the next example:

19.10.3 CUPS “*PostScript Driver for Windows NT/200x/XP*”

CUPS users may get the exact same packages from <http://www.cups.org/software.html>. It is a separate package from the CUPS base software files, tagged as CUPS 1.1.x Windows NT/200x/XP Printer Driver for Samba (tar.gz, 192k). The filename to download is **cups-samba-1.1.x.tar.gz**. Upon untar and unzipping, it will reveal these files:

```
root# tar xvzf cups-samba-1.1.19.tar.gz
cups-samba.install
cups-samba.license
cups-samba.readme
cups-samba.remove
```

Example 19.10.1. smb.conf for cupsaddsmb usage

```
[global]
    load printers = yes
    printing = cups
    printcap name = cups

[printers]
    comment = All Printers
    path = /var/spool/samba
    browseable = no
    public = yes
# setting depends on your requirements
    guest ok = yes
    writable = no
    printable = yes
    printer admin = root

[print$]
    comment = Printer Drivers
    path = /etc/samba/drivers
    browseable = yes
    guest ok = no
    read only = yes
    write list = root
```

cups-samba.ss

These have been packaged with the ESP meta packager software EPM. The `*.install` and `*.remove` files are simple shell scripts, which untars the `*.ss` (the `*.ss` is nothing else but a tar-archive, which can be untarred by “tar” too). Then it puts the content into `/usr/share/cups/drivers/`. This content includes three files:

```
root# tar tv cups-samba.ss
cupsdrv.dll
cupsui.dll
cups.hlp
```

The `cups-samba.install` shell scripts are easy to handle:

```
root# ./cups-samba.install
[....]
Installing software...
Updating file permissions...
```

```
Running post-install commands...
Installation is complete.
```

The script should automatically put the driver files into the `/usr/share/cups/drivers/` directory.

WARNING

Due to a bug, one recent CUPS release puts the `cups.hlp` driver file into `/usr/share/drivers/` instead of `/usr/share/cups/drivers/`. To work around this, copy/move the file (after running the `./cups-samba.install` script) manually to the correct place.

```
root# cp /usr/share/drivers/cups.hlp /usr/share/cups/drivers/
```

This new CUPS PostScript driver is currently binary-only, but free of charge. No complete source code is provided (yet). The reason is that it has been developed with the help of the Microsoft Driver Developer Kit (DDK) and compiled with Microsoft Visual Studio 6. Driver developers are not allowed to distribute the whole of the source code as free software. However, CUPS developers released the “*diff*” in source code under the GPL, so anybody with a license of Visual Studio and a DDK will be able to compile for him/herself.

19.10.4 Recognizing Different Driver Files

The CUPS drivers do not support the older Windows 95/98/Me, but only the Windows NT/2000/XP client.

Windows NT, 2000 and XP are supported by:

- `cups.hlp`
- `cupsdrv.dll`
- `cupsui.dll`

Adobe drivers are available for the older Windows 95/98/Me as well as the Windows NT/2000/XP clients. The set of files is different from the different platforms.

Windows 95, 98 and ME are supported by:

- `ADFONT.SMF`
- `ADOBEP4.DRV`
- `ADOBEP4.HLP`
- `DEFPRTR2.PPD`

- ICONLIB.DLL
- PSMON.DLL

Windows NT, 2000 and XP are supported by:

- ADOBEPS5.DLL
- ADOBEPSU.DLL
- ADOBEPSU.HLP

NOTE



If both the Adobe driver files and the CUPS driver files for the support of Windows NT/200x/XP are present in `FIXME`, the Adobe ones will be ignored and the CUPS ones will be used. If you prefer — for whatever reason — to use Adobe-only drivers, move away the three CUPS driver files. The Windows 9x/Me clients use the Adobe drivers in any case.

19.10.5 Acquiring the Adobe Driver Files

Acquiring the Adobe driver files seems to be unexpectedly difficult for many users. They are not available on the Adobe Web site as single files and the self-extracting and/or self-installing Windows-.exe is not easy to locate either. Probably you need to use the included native installer and run the installation process on one client once. This will install the drivers (and one Generic PostScript printer) locally on the client. When they are installed, share the Generic PostScript printer. After this, the client's `[print$]` share holds the Adobe files, from where you can get them with `smbclient` from the CUPS host.

19.10.6 ESP Print Pro PostScript Driver for Windows NT/200x/XP

Users of the ESP Print Pro software are able to install their Samba drivers package for this purpose with no problem. Retrieve the driver files from the normal download area of the ESP Print Pro software at <http://www.easysw.com/software.html>. You need to locate the link labeled “*SAMBA*” among the **Download Printer Drivers for ESP Print Pro 4.x** area and download the package. Once installed, you can prepare any driver by simply highlighting the printer in the Printer Manager GUI and select **Export Driver...** from the menu. Of course you need to have prepared Samba beforehand to handle the driver files; i.e., setup the `[print$]` share, and so on. The ESP Print Pro package includes the CUPS driver files as well as a (licensed) set of Adobe drivers for the Windows 95/98/Me client family.

19.10.7 Caveats to be Considered

Once you have run the install script (and possibly manually moved the `cups.hlp` file to `/usr/share/cups/drivers/`), the driver is ready to be put into Samba's `[print$]` share (which often maps to `/etc/samba/drivers/` and contains a subdirectory tree with `WIN40` and `W32X86` branches). You do this by running `cupsaddsmb` (see also `man cupsaddsmb` for CUPS since release 1.1.16).

TIP



You may need to put root into the `smbpasswd` file by running `smbpasswd`; this is especially important if you should run this whole procedure for the first time, and are not working in an environment where everything is configured for *single sign on* to a Windows Domain Controller.

Once the driver files are in the `[print$]` share and are initialized, they are ready to be downloaded and installed by the Windows NT/200x/XP clients.

NOTE



Win 9x/Me clients will not work with the CUPS PostScript driver. For these you still need to use the `ADOBE*. *` drivers as previously stated.

NOTE



It is not harmful if you still have the `ADOBE*. *` driver files from previous installations in the `/usr/share/cups/drivers/` directory. The new `cupsaddsmb` (from 1.1.16) will automatically prefer its own drivers if it finds both.

NOTE



Should your Windows clients have had the old ADOBE*. * files for the Adobe PostScript driver installed, the download and installation of the new CUPS PostScript driver for Windows NT/200x/XP will fail at first. You need to wipe the old driver from the clients first. It is not enough to “delete” the printer, as the driver files will still be kept by the clients and re-used if you try to re-install the printer. To really get rid of the Adobe driver files on the clients, open the **Printers** folder (possibly via **Start > Settings > Control Panel > Printers**), right-click on the folder background and select **Server Properties**. When the new dialog opens, select the **Drivers** tab. On the list select the driver you want to delete and click the **Delete** button. This will only work if there is not one single printer left that uses that particular driver. You need to “delete” all printers using this driver in the **Printers** folder first. You will need Administrator privileges to do this.

NOTE



Once you have successfully downloaded the CUPS PostScript driver to a client, you can easily switch all printers to this one by proceeding as described in Classical Printing Support. Either change a driver for an existing printer by running the **Printer Properties** dialog, or use **rpcclient** with the **setdriver** subcommand.

19.10.8 Windows CUPS PostScript Driver Versus Adobe Driver

Are you interested in a comparison between the CUPS and the Adobe PostScript drivers? For our purposes these are the most important items that weigh in favor of the CUPS ones:

- No hassle with the Adobe EULA.
- No hassle with the question “Where do I get the ADOBE*. * driver files from?”
- The Adobe drivers (on request of the printer PPD associated with them) often put a PJI header in front of the main PostScript part of the print file. Thus, the printfile starts with `<1B >%-12345X` or `<escape>%-12345X` instead of `%!PS`). This leads to the CUPS daemon auto-typing the incoming file as a print-ready file, not initiating a pass through the *pstops* filter (to speak more technically, it is not regarded as the generic MIME-type *application/postscript*, but as the more special MIME type *application/cups.vnd-postscript*), which therefore also leads to the page accounting in `/var/log/cups/page.log` not receiving the exact number of pages; instead the dummy page number of “1” is logged in a standard setup).

- The Adobe driver has more options to mis-configure the PostScript generated by it (like setting it inadvertently to **Optimize for Speed**, instead of **Optimize for Portability**, which could lead to CUPS being unable to process it).
- The CUPS PostScript driver output sent by Windows clients to the CUPS server is guaranteed to auto-type as the generic MIME type *application/postscript*, thus passing through the CUPS *pstops* filter and logging the correct number of pages in the `page_log` for accounting and quota purposes.
- The CUPS PostScript driver supports the sending of additional standard (IPP) print options by Windows NT/200x/XP clients. Such additional print options are: naming the CUPS standard *banner pages* (or the custom ones, should they be installed at the time of driver download), using the CUPS page-label option, setting a job-priority, and setting the scheduled time of printing (with the option to support additional useful IPP job attributes in the future).
- The CUPS PostScript driver supports the inclusion of the new **cupsJobTicket* comments at the beginning of the PostScript file (which could be used in the future for all sort of beneficial extensions on the CUPS side, but which will not disturb any other applications as they will regard it as a comment and simply ignore it).
- The CUPS PostScript driver will be the heart of the fully fledged CUPS IPP client for Windows NT/200x/XP to be released soon (probably alongside the first beta release for CUPS 1.2).

19.10.9 Run cupsaddsmb (Quiet Mode)

The `cupsaddsmb` command copies the needed files into your `[print$]` share. Additionally, the PPD associated with this printer is copied from `/etc/cups/ppd/` to `[print$]`. There the files wait for convenient Windows client installations via Point'n'Print. Before we can run the command successfully, we need to be sure that we can authenticate toward Samba. If you have a small network, you are probably using user-level security (`security = user`).

Here is an example of a successfully run `cupsaddsmb` command:

```
root# cupsaddsmb -U root infotec_IS2027
Password for root required to access localhost via Samba: ['secret']
```

To share *all* printers and drivers, use the `-a` parameter instead of a printer name. Since `cupsaddsmb` “*exports*” the printer drivers to Samba, it should be obvious that it only works for queues with a CUPS driver associated.

19.10.10 Run cupsaddsmb with Verbose Output

Probably you want to see what’s going on. Use the `-v` parameter to get a more verbose output. The output below was edited for better readability: all “\” at the end of a line indicate that I inserted an artificial line break plus some indentation here:

WARNING

You will see the root password for the Samba account printed on screen.

```

root# cupsaddsmb -U root -v infotec_2105
Password for root required to access localhost via GANDALF:
Running command: smbclient //localhost/print/$ -N -U'root%secret' \
  -c 'mkdir W32X86; \
    put /var/spool/cups/tmp/3e98bf2d333b5 W32X86/infotec_2105.ppd; \
    put /usr/share/cups/drivers/cupsdrv.dll W32X86/cupsdrv.dll; \
    put /usr/share/cups/drivers/cupsui.dll W32X86/cupsui.dll; \
    put /usr/share/cups/drivers/cups.hlp W32X86/cups.hlp'
added interface ip=10.160.51.60 bcast=10.160.51.255 nmask=255.255.252.0
Domain=[CUPS-PRINT] OS=[UNIX] Server=[Samba 2.2.7a]
NT_STATUS_OBJECT_NAME_COLLISION making remote directory \W32X86
putting file /var/spool/cups/tmp/3e98bf2d333b5 as \W32X86/infotec_2105.ppd
putting file /usr/share/cups/drivers/cupsdrv.dll as \W32X86/cupsdrv.dll
putting file /usr/share/cups/drivers/cupsui.dll as \W32X86/cupsui.dll
putting file /usr/share/cups/drivers/cups.hlp as \W32X86/cups.hlp

Running command: rpcclient localhost -N -U'root%secret'
  -c 'adddriver "Windows NT x86" \
    "infotec_2105:cupsdrv.dll:infotec_2105.ppd:cupsui.dll:cups.hlp:NULL: \
    RAW:NULL"'
cmd = adddriver "Windows NT x86" \
  "infotec_2105:cupsdrv.dll:infotec_2105.ppd:cupsui.dll:cups.hlp:NULL: \
  RAW:NULL"
Printer Driver infotec_2105 successfully installed.

Running command: smbclient //localhost/print/$ -N -U'root%secret' \
  -c 'mkdir WIN40; \
    put /var/spool/cups/tmp/3e98bf2d333b5 WIN40/infotec_2105.PPD; \
    put /usr/share/cups/drivers/ADFFONTS.MFM WIN40/ADFFONTS.MFM; \
    put /usr/share/cups/drivers/ADOBEPS4.DRV WIN40/ADOBEPS4.DRV; \
    put /usr/share/cups/drivers/ADOBEPS4.HLP WIN40/ADOBEPS4.HLP; \
    put /usr/share/cups/drivers/DEFPRTR2.PPD WIN40/DEFPRTR2.PPD; \
    put /usr/share/cups/drivers/ICONLIB.DLL WIN40/ICONLIB.DLL; \
    put /usr/share/cups/drivers/PSMON.DLL WIN40/PSMON.DLL; \
    added interface ip=10.160.51.60 bcast=10.160.51.255 nmask=255.255.252.0
Domain=[CUPS-PRINT] OS=[UNIX] Server=[Samba 2.2.7a]
NT_STATUS_OBJECT_NAME_COLLISION making remote directory \WIN40
putting file /var/spool/cups/tmp/3e98bf2d333b5 as \WIN40/infotec_2105.PPD

```



```

putting file /usr/share/cups/drivers/ADFONTS.MFM as \WIN40/ADFONTS.MFM
putting file /usr/share/cups/drivers/ADOBEPS4.DRV as \WIN40/ADOBEPS4.DRV
putting file /usr/share/cups/drivers/ADOBEPS4.HLP as \WIN40/ADOBEPS4.HLP
putting file /usr/share/cups/drivers/DEFPRTR2.PPD as \WIN40/DEFPRTR2.PPD
putting file /usr/share/cups/drivers/ICONLIB.DLL as \WIN40/ICONLIB.DLL
putting file /usr/share/cups/drivers/PSMON.DLL as \WIN40/PSMON.DLL

```

```

Running command: rpcclient localhost -N -U'root%secret' \
-c 'adddriver "Windows 4.0" \
"infotec_2105:ADOBEPS4.DRV:infotec_2105.PPD:NULL:ADOBEPS4.HLP: \
PSMON.DLL:RAW:ADOBEPS4.DRV,infotec_2105.PPD,ADOBEPS4.HLP,PSMON.DLL, \
ADFONTS.MFM,DEFPRTR2.PPD,ICONLIB.DLL"'
cmd = adddriver "Windows 4.0" "infotec_2105:ADOBEPS4.DRV:\
infotec_2105.PPD:NULL:ADOBEPS4.HLP:PSMON.DLL:RAW:ADOBEPS4.DRV,\
infotec_2105.PPD,ADOBEPS4.HLP,PSMON.DLL,ADFONTS.MFM,DEFPRTR2.PPD,\
ICONLIB.DLL"
Printer Driver infotec_2105 successfully installed.

```

```

Running command: rpcclient localhost -N -U'root%secret' \
-c 'setdriver infotec_2105 infotec_2105'
cmd = setdriver infotec_2105 infotec_2105
Successfully set infotec_2105 to driver infotec_2105.

```

If you look closely, you'll discover your root password was transferred unencrypted over the wire, so beware! Also, if you look further, you'll discover error messages like `NT_STATUS_OBJECT_NAME_COLLISION` in between. They occur, because the directories `WIN40` and `W32X86` already existed in the `[print$]` driver download share (from a previous driver installation). They are harmless here.

19.10.11 Understanding cupsaddsmb

What has happened? What did `cupsaddsmb` do? There are five stages of the procedure:

1. Call the CUPS server via IPP and request the driver files and the PPD file for the named printer.
2. Store the files temporarily in the local `TEMPDIR` (as defined in `cupsd.conf`).
3. Connect via `smbclient` to the Samba server's `[print$]` share and put the files into the share's `WIN40` (for Windows 9x/Me) and `W32X86/` (for Windows NT/200x/XP) subdirectories.
4. Connect via `rpcclient` to the Samba server and execute the `adddriver` command with the correct parameters.
5. Connect via `rpcclient` to the Samba server a second time and execute the `setdriver` command.

NOTE



You can run the **cupsaddsmb** utility with parameters to specify one remote host as Samba host and a second remote host as CUPS host. Especially if you want to get a deeper understanding, it is a good idea to try it and see more clearly what is going on (though in real life most people will have their CUPS and Samba servers run on the same host):

```
root# cupsaddsmb -H sambaserver -h cupserver -v printer
```

19.10.12 How to Recognize If cupsaddsmb Completed Successfully

You *must* always check if the utility completed successfully in all fields. You need as a minimum these three messages among the output:

1. *Printer Driver infotec_2105 successfully installed. #* (for the W32X86 == Windows NT/200x/XP architecture).
2. *Printer Driver infotec_2105 successfully installed. #* (for the WIN40 == Windows 9x/Me architecture).
3. *Successfully set [printerXPZ] to driver [printerXYZ].*

These messages are probably not easily recognized in the general output. If you run **cupsaddsmb** with the **-a** parameter (which tries to prepare *all* active CUPS printer drivers for download), you might miss if individual printers drivers had problems installing properly. Here a redirection of the output will help you analyze the results in retrospective.

If you get:

```
SetPrinter call failed!  
result was WERR_ACCESS_DENIED
```

It means that you might have set `use client driver = yes` for this printer. Set it to `"no"` will solve the problem. Refer to `man samba(5)` for explanation on *use client driver*.

NOTE



It is impossible to see any diagnostic output if you do not run **cupsaddsmb** in verbose mode. Therefore, we strongly recommend to not use the default quiet mode. It will hide any problems from you that might occur.

19.10.13 cupsaddsmb with a Samba PDC

Can't get the standard **cupsaddsmb** command to run on a Samba PDC? Are you asked for the password credential all over again and again and the command just will not take off at all? Try one of these variations:

```
root# cupsaddsmb -U MIDEARTH\\root -v printername
root# cupsaddsmb -H SAURON -U MIDEARTH\\root -v printername
root# cupsaddsmb -H SAURON -U MIDEARTH\\root -h cups-server -v printername
```

(Note the two backslashes: the first one is required to “*escape*” the second one).

19.10.14 cupsaddsmb Flowchart

cupsaddsmb flowchart shows a chart about the procedures, command-flows and data-flows of the **cupsaddsmb** command. Note again: **cupsaddsmb** is not intended to, and does not work with, raw queues!

19.10.15 Installing the PostScript Driver on a Client

After **cupsaddsmb** is completed, your driver is prepared for the clients to use. Here are the steps you must perform to download and install it via Point'n'Print. From a Windows client, browse to the CUPS/Samba server:

- Open the **Printers** share of Samba in Network Neighborhood.
- Right-click on the printer in question.
- From the opening context-menu select **Install...** or **Connect...** (depending on the Windows version you use).

After a few seconds, there should be a new printer in your client's *local Printers* folder. On Windows XP it will follow a naming convention of *PrinterName on SambaServer*. (In my current case it is "infotec_2105 on kde-bitshop"). If you want to test it and send your first job from an application like Winword, the new printer appears in a `\\SambaServer\PrinterName` entry in the drop-down list of available printers.

cupsaddsmb will only reliably work with CUPS version 1.1.15 or higher and Samba from 2.2.4. If it does not work, or if the automatic printer driver download to the clients does

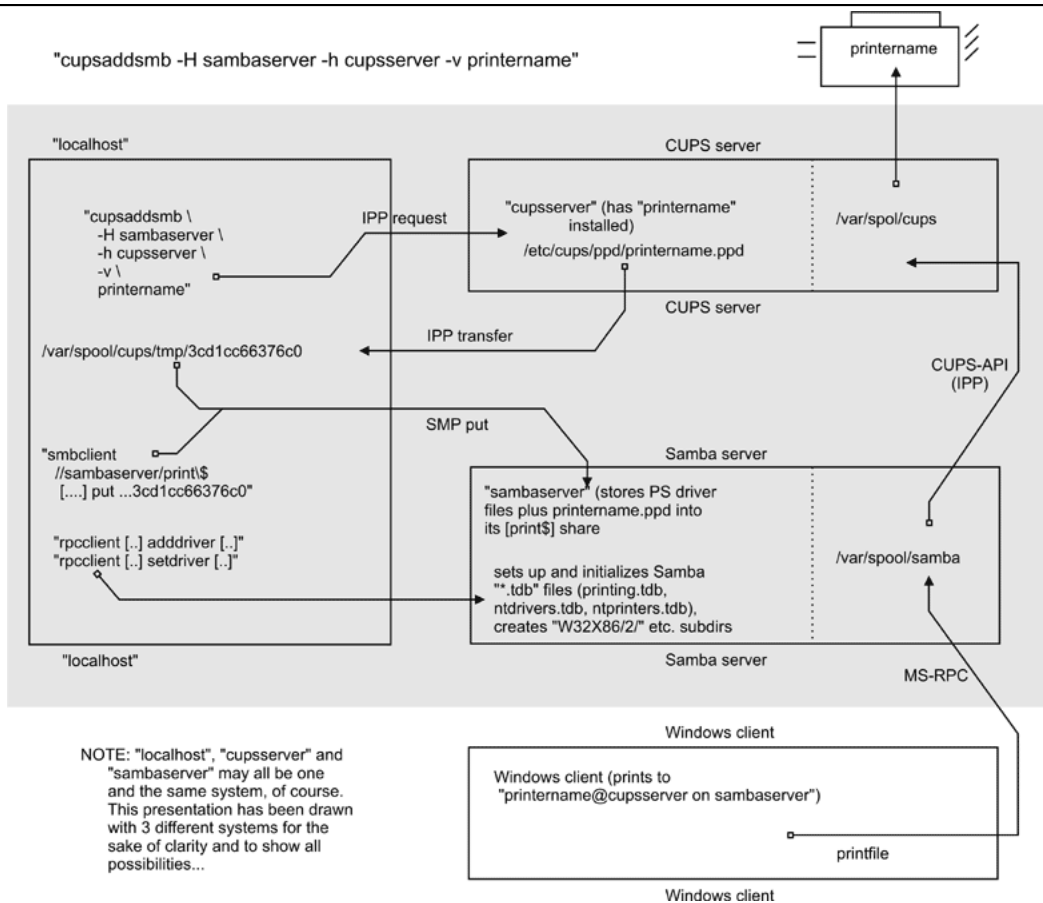

Figure 19.16. cupsaddsmb flowchart.

not succeed, you can still manually install the CUPS printer PPD on top of the Adobe PostScript driver on clients. Then point the client's printer queue to the Samba printer share for a UNC type of connection:

```
C:\> net use lpt1: \\sambaserver\printershare /user:ntadmin
```

should you desire to use the CUPS networked PostScript RIP functions. (Note that user `"ntadmin"` needs to be a valid Samba user with the required privileges to access the printer share.) This sets up the printer connection in the traditional *LanMan* way (not using MS-RPC).

19.10.16 Avoiding Critical PostScript Driver Settings on the Client

Printing works, but there are still problems. Most jobs print well, some do not print at all. Some jobs have problems with fonts, which do not look very good. Some jobs print fast

and some are dead-slow. Many of these problems can be greatly reduced or even completely eliminated if you follow a few guidelines. Remember, if your print device is not PostScript-enabled, you are treating your Ghostscript installation on your CUPS host with the output your client driver settings produce. Treat it well:

- Avoid the PostScript Output Option: Optimize for Speed setting. Use the Optimize for Portability instead (Adobe PostScript driver).
- Don't use the Page Independence: NO setting. Instead, use Page Independence YES (CUPS PostScript Driver).
- Recommended is the True Type Font Downloading Option: Native True Type over Automatic and Outline; you should by all means avoid Bitmap (Adobe PostScript Driver).
- Choose True Type Font: Download as Softfont into Printer over the default Replace by Device Font (for exotic fonts, you may need to change it back to get a printout at all) (Adobe).
- Sometimes you can choose PostScript Language Level: In case of problems try 2 instead of 3 (the latest ESP Ghostscript package handles Level 3 PostScript very well) (Adobe).
- Say Yes to PostScript Error Handler (Adobe).

19.11 Installing PostScript Driver Files Manually Using `rpcclient`

Of course, you can run all the commands that are embedded into the `cupsaddsmb` convenience utility yourself, one by one, and hereby upload and prepare the driver files for future client downloads.

1. Prepare Samba (A CUPS print queue with the name of the printer should be there. We are providing the driver now).
2. Copy all files to `[print$]`.
3. Run `rpcclient adddriver` (for each client architecture you want to support).
4. Run `rpcclient setdriver`.

We are going to do this now. First, read the man page on `rpcclient` to get a first idea. Look at all the printing related subcommands. `enumprinters`, `enumdrivers`, `enumports`, `adddriver`, `setdriver` are among the most interesting ones. `rpcclient` implements an important part of the MS-RPC protocol. You can use it to query (and command) a Windows NT (or 200x/XP) PC, too. MS-RPC is used by Windows clients, among other things, to benefit from the Point'n'Print features. Samba can now mimic this as well.

19.11.1 A Check of the `rpcclient` man Page

First let's check the `rpcclient` man page. Here are two relevant passages:

adddriver <arch> <config> Execute an **AddPrinterDriver()** RPC to install the printer driver information on the server. The driver files should already exist in the directory returned by **getdriverdir**. Possible values for *arch* are the same as those for the **getdriverdir** command. The *config* parameter is defined as follows:

```
Long Printer Name:\
Driver File Name:\
Data File Name:\
Config File Name:\
Help File Name:\
Language Monitor Name:\
Default Data Type:\
Comma Separated list of Files
```

Any empty fields should be enter as the string “*NULL*”.

Samba does not need to support the concept of Print Monitors since these only apply to local printers whose driver can make use of a bi-directional link for communication. This field should be “*NULL*”. On a remote NT print server, the Print Monitor for a driver must already be installed prior to adding the driver or else the RPC will fail.

setdriver <printrername> <drivername> Execute a **SetPrinter()** command to update the printer driver associated with an installed printer. The printer driver must already be correctly installed on the print server.

See also the **enumprinters** and **enumdrivers** commands for obtaining a list of installed printers and drivers.

19.11.2 Understanding the `rpcclient` man Page

The *exact* format isn’t made too clear by the man page, since you have to deal with some parameters containing spaces. Here is a better description for it. We have line-broken the command and indicated the breaks with “\”. Usually you would type the command in one line without the line-breaks:

```
adddriver "Architecture" \
    "LongPrinterName:DriverFile:DataFile:ConfigFile:HelpFile:\
    LanguageMonitorFile:DataType:ListOfFiles,Comma-separated"
```

What the man pages denote as a simple <*config*> keyword, in reality consists of eight colon-separated fields. The last field may take multiple (in some very insane cases, even 20 different additional) files. This might sound confusing at first. What the man pages names the “*LongPrinterName*” in reality should be called the “*Driver Name*”. You can name it anything you want, as long as you use this name later in the **rpcclient ... setdriver** command. For practical reasons, many name the driver the same as the printer.

It isn’t simple at all. I hear you asking: “*How do I know which files are ”Driver File”, “Data File”, “Config File”, “Help File” and “Language Monitor File” in each case?*” — For

an answer, you may want to have a look at how a Windows NT box with a shared printer presents the files to us. Remember, that this whole procedure has to be developed by the Samba team by overhearing the traffic caused by Windows computers on the wire. We may as well turn to a Windows box now and access it from a UNIX workstation. We will query it with **rpcclient** to see what it tells us and try to understand the man page more clearly that we've read just now.

19.11.3 Producing an Example by Querying a Windows Box

We could run **rpcclient** with a **getdriver** or a **getprinter** subcommand (in level 3 verbosity) against it. Just sit down at a UNIX or Linux workstation with the Samba utilities installed, then type the following command:

```
root# rpcclient -U'user%secret' NT-SERVER -c 'getdriver printername 3'
```

From the result it should become clear which is which. Here is an example from my installation:

```
root# rpcclient -U'Danka%xxxx' W200xSERVER \
-c'getdriver "DANKA InfoStream Virtual Printer" 3'
cmd = getdriver "DANKA InfoStream Virtual Printer" 3
```

```
[Windows NT x86]
```

```
Printer Driver Info 3:
```

```
Version: [2]
```

```
Driver Name: [DANKA InfoStream]
```

```
Architecture: [Windows NT x86]
```

```
Driver Path: [C:\WINNT\System32\spool\DRIVERS\W32X86\2\PSCRIPT.DLL]
```

```
Datafile: [C:\WINNT\System32\spool\DRIVERS\W32X86\2\INFOSTRM.PPD]
```

```
Configfile: [C:\WINNT\System32\spool\DRIVERS\W32X86\2\PSCRPTUI.DLL]
```

```
Helpfile: [C:\WINNT\System32\spool\DRIVERS\W32X86\2\PSCRIPT.HLP]
```

```
Dependentfiles: []
```

```
Dependentfiles: []
```

```
Dependentfiles: []
```

```
Dependentfiles: []
```

```
Dependentfiles: []
```

```
Dependentfiles: []
```

```
Dependentfiles: []
```

```
Monitorname: []
```

```
Defaultdatatype: []
```

Some printer drivers list additional files under the label *Dependentfiles* and these would go into the last field *ListOfFiles, Comma-separated*. For the CUPS PostScript drivers, we

do not need any (nor would we for the Adobe PostScript driver), therefore, the field will get a “*NULL*” entry.

19.11.4 Requirements for `adddriver` and `setdriver` to Succeed

>From the man page (and from the quoted output of `cupsaddsmb` above) it becomes clear that you need to have certain conditions in order to make the manual uploading and initializing of the driver files succeed. The two `rpcclient` subcommands (`adddriver` and `setdriver`) need to encounter the following preconditions to complete successfully:

- You are connected as printer admin or root (this is *not* the “*Printer Operators*” group in NT, but the *printer admin* group as defined in the `[global]` section of `smb.conf`).
- Copy all required driver files to `\\SAMBA\print$\w32x86` and `\\SAMBA\print$\win40` as appropriate. They will end up in the “*0*” respective “*2*” subdirectories later. For now, *do not* put them there, they’ll be automatically used by the `adddriver` subcommand. (If you use `smbclient` to put the driver files into the share, note that you need to escape the “*\$*”: `smbclient //sambaserver/print\$ -U root.`)
- The user you’re connecting as must be able to write to the `[print$]` share and create subdirectories.
- The printer you are going to setup for the Windows clients needs to be installed in CUPS already.
- The CUPS printer must be known to Samba, otherwise the `setdriver` subcommand fails with an `NT_STATUS_UNSUCCESSFUL` error. To check if the printer is known by Samba, you may use the `enumprinters` subcommand to `rpcclient`. A long-standing bug prevented a proper update of the printer list until every `smbd` process had received a `SIGHUP` or was restarted. Remember this in case you’ve created the CUPS printer just recently and encounter problems: try restarting Samba.

19.11.5 Manual Driver Installation in 15 Steps

We are going to install a printer driver now by manually executing all required commands. As this may seem a rather complicated process at first, we go through the procedure step by step, explaining every single action item as it comes up. Manual Driver Installation

1. Install the printer on CUPS.

```
root# lpadmin -p mysmbtstprn -v socket://10.160.51.131:9100 -E \  
-P canonIR85.ppd
```

This installs a printer with the name `mysmbtstprn` to the CUPS system. The printer is accessed via a socket (a.k.a. JetDirect or Direct TCP/IP) connection. You need to be root for this step.

2. (Optional) Check if the printer is recognized by Samba.

```

root# rpcclient -Uroot%xxxx -c 'enumprinters' localhost \
| grep -C2 mysmbtstprn
flags: [0x800000]
name: [\\kde-bitshop\mysmbtstprn]
description: [\\kde-bitshop\mysmbtstprn,,mysmbtstprn]
comment: [mysmbtstprn]

```

This should show the printer in the list. If not, stop and restart the Samba daemon (smbd), or send a HUP signal:

```

root# kill -HUP `pidof smbd`

```

Check again. Troubleshoot and repeat until successful. Note the “*empty*” field between the two commas in the “*description*” line. The driver name would appear here if there was one already. You need to know root’s Samba password (as set by the **smbpasswd** command) for this step and most of the following steps. Alternately, you can authenticate as one of the users from the “*write list*” as defined in `smb.conf` for `[print$]`.

3. (Optional) Check if Samba knows a driver for the printer.

```

root# rpcclient -Uroot%xxxx -c 'getprinter mysmbtstprn 2' localhost \
| grep driver
drivename: []

```

```

root# rpcclient -Uroot%xxxx -c 'getprinter mysmbtstprn 2' localhost \
| grep -C4 driv
servername: [\\kde-bitshop]
printername: [\\kde-bitshop\mysmbtstprn]
sharename: [mysmbtstprn]
portname: [Samba Printer Port]
drivename: []
comment: [mysmbtstprn]
location: []
sepfile: []
printprocessor: [winprint]

```

```

root# rpcclient -U root%xxxx -c 'getdriver mysmbtstprn' localhost
result was WERR_UNKNOWN_PRINTER_DRIVER

```

None of the three commands shown above should show a driver. This step was done for the purpose of demonstrating this condition. An attempt to connect to the printer at this stage will prompt the message along the lines of: “*The server does not have the required printer driver installed.*”

4. Put all required driver files into Samba's [print\$].

```
root# smbclient //localhost/print\$ -U 'root%xxxx' \
-c 'cd W32X86; \
put /etc/cups/ppd/mysmbtstprn.ppd mysmbtstprn.PPD; \
put /usr/share/cups/drivers/cupsui.dll cupsui.dll; \
put /usr/share/cups/drivers/cupsdrv.dll cupsdrv.dll; \
put /usr/share/cups/drivers/cups.hlp cups.hlp'
```

(This command should be entered in one long single line. Line-breaks and the line-end indicated by “\” have been inserted for readability reasons.) This step is *required* for the next one to succeed. It makes the driver files physically present in the [print\$] share. However, clients would still not be able to install them, because Samba does not yet treat them as driver files. A client asking for the driver would still be presented with a “*not installed here*” message.

5. Verify where the driver files are now.

```
root# ls -l /etc/samba/drivers/W32X86/
total 669
drwxr-sr-x  2 root    ntadmin    532 May 25 23:08 2
drwxr-sr-x  2 root    ntadmin    670 May 16 03:15 3
-rwxr--r--  1 root    ntadmin   14234 May 25 23:21 cups.hlp
-rwxr--r--  1 root    ntadmin  278380 May 25 23:21 cupsdrv.dll
-rwxr--r--  1 root    ntadmin  215848 May 25 23:21 cupsui.dll
-rwxr--r--  1 root    ntadmin  169458 May 25 23:21 mysmbtstprn.PPD
```

The driver files now are in the W32X86 architecture “*root*” of [print\$].

6. Tell Samba that these are driver files (adddriver).

```
root# rpcclient -Uroot%xxxx -c 'adddriver "Windows NT x86" \
"mydrivername:cupsdrv.dll:mysmbtstprn.PPD: \
cupsui.dll:cups.hlp:NULL:RAW:NULL"' \
localhost
Printer Driver mydrivername successfully installed.
```

You cannot repeat this step if it fails. It could fail even as a result of a simple typo. It will most likely have moved a part of the driver files into the “2” subdirectory. If this step fails, you need to go back to the fourth step and repeat it before you can try this one again. In this step, you need to choose a name for your driver. It is normally a good idea to use the same name as is used for the printer name; however, in big installations you may use this driver for a number of printers that obviously have different names, so the name of the driver is not fixed.

7. Verify where the driver files are now.

```

root# ls -l /etc/samba/drivers/W32X86/
total 1
drwxr-sr-x  2 root    ntadmin    532 May 25 23:22 2
drwxr-sr-x  2 root    ntadmin    670 May 16 03:15 3

root# ls -l /etc/samba/drivers/W32X86/2
total 5039
[....]
-rwxr--r--  1 root    ntadmin    14234 May 25 23:21 cups.hlp
-rwxr--r--  1 root    ntadmin    278380 May 13 13:53 cupsdrv.dll
-rwxr--r--  1 root    ntadmin    215848 May 13 13:53 cupsui.dll
-rwxr--r--  1 root    ntadmin    169458 May 25 23:21 mysmbtstprn.PPD

```

Notice how step 6 also moved the driver files to the appropriate subdirectory. Compare this with the situation after step 5.

8. (Optional) Verify if Samba now recognizes the driver.

```

root# rpcclient -Uroot%xxxx -c 'enumdrivers 3' \
  localhost | grep -B2 -A5 mydrivername
Printer Driver Info 3:
Version: [2]
Driver Name: [mydrivername]
Architecture: [Windows NT x86]
Driver Path: [\\kde-bitshop\print$\W32X86\2\cupsdrv.dll]
Datafile: [\\kde-bitshop\print$\W32X86\2\mysmbtstprn.PPD]
Configfile: [\\kde-bitshop\print$\W32X86\2\cupsui.dll]
Helpfile: [\\kde-bitshop\print$\W32X86\2\cups.hlp]

```

Remember, this command greps for the name you chose for the driver in step 6. This command must succeed before you can proceed.

9. Tell Samba which printer should use these driver files (**setdriver**).

```

root# rpcclient -Uroot%xxxx -c 'setdriver mysmbtstprn mydrivername' \
  localhost
Successfully set mysmbtstprn to driver mydrivername

```

Since you can bind any printername (print queue) to any driver, this is a convenient way to setup many queues that use the same driver. You do not need to repeat all the previous steps for the **setdriver** command to succeed. The only preconditions are: **enumdrivers** must find the driver and **enumprinters** must find the printer.

10. (Optional) Verify if Samba has recognized this association.

```
root# rpcclient -Uroot%xxxx -c 'getprinter mysmbtstprn 2' localhost \
| grep driver
drivername: [mydrivername]

root# rpcclient -Uroot%xxxx -c 'getprinter mysmbtstprn 2' localhost \
| grep -C4 driv
servername: [\\kde-bitshop]
printername: [\\kde-bitshop\mysmbtstprn]
sharename: [mysmbtstprn]
portname: [Done]
drivername: [mydrivername]
comment: [mysmbtstprn]
location: []
sepfiler: []
printprocessor: [winprint]

root# rpcclient -U root%xxxx -c 'getdriver mysmbtstprn' localhost
[Windows NT x86]
Printer Driver Info 3:
  Version: [2]
  Driver Name: [mydrivername]
  Architecture: [Windows NT x86]
  Driver Path: [\\kde-bitshop\print$\W32X86\2\cupsdrvrv.dll]
  Datafile: [\\kde-bitshop\print$\W32X86\2\mysmbtstprn.PPD]
  Configfile: [\\kde-bitshop\print$\W32X86\2\cupsui.dll]
  Helpfile: [\\kde-bitshop\print$\W32X86\2\cups.hlp]
  Monitorname: []
  Defaultdatatype: [RAW]
  Monitorname: []
  Defaultdatatype: [RAW]

root# rpcclient -Uroot%xxxx -c 'enumprinters' localhost \
| grep mysmbtstprn
name: [\\kde-bitshop\mysmbtstprn]
description: [\\kde-bitshop\mysmbtstprn,mydrivername,mysmbtstprn]
comment: [mysmbtstprn]
```

Compare these results with the ones from steps 2 and 3. Every one of these commands show the driver is installed. Even the **enumprinters** command now lists the driver on the “*description*” line.

11. **(Optional) Tickle the driver into a correct device mode.** You certainly know how to install the driver on the client. In case you are not particularly familiar with Windows, here is a short recipe: Browse the Network Neighborhood, go to the Samba server, and look for the shares. You should see all shared Samba printers. Double-click on the one in question. The driver should get installed and the network connection

set up. An alternate way is to open the **Printers (and Faxes)** folder, right-click on the printer in question and select **Connect** or **Install**. As a result, a new printer should have appeared in your client's local **Printers (and Faxes)** folder, named something like **printersharename on Sambahostname**. It is important that you execute this step as a Samba printer admin (as defined in `smb.conf`). Here is another method to do this on Windows XP. It uses a command line, which you may type into the “DOS box” (type root's smbpassword when prompted):

```
C:\> runas /netonly /user:root "rundll32 printui.dll,PrintUIEntry \
    /in /n \\sambaserver\mysmbtstprn"
```

Change any printer setting once (like changing **portrait to landscape**), click on **Apply**; change the setting back.

12. Install the printer on a client (Point'n'Print).

```
C:\> rundll32 printui.dll,PrintUIEntry /in /n \\sambaserver\mysmbtstprn
```

If it does not work it could be a permission problem with the `[print$]` share.

13. (Optional) Print a test page.

```
C:\> rundll32 printui.dll,PrintUIEntry /p /n "\\sambaserver\mysmbtstprn"
```

Then hit [TAB] five times, [ENTER] twice, [TAB] once and [ENTER] again and march to the printer.

14. (Recommended) Study the test page. Hmmm.... just kidding! By now you know everything about printer installations and you do not need to read a word. Just put it in a frame and bolt it to the wall with the heading "MY FIRST RPCCLIENT-INSTALLED PRINTER" — why not just throw it away!

15. (Obligatory) Enjoy. Jump. Celebrate your success.

```
root# echo "Cheeeeeerioooooo! Success..." >> /var/log/samba/log.smbd
```

19.11.6 Troubleshooting Revisited

The `setdriver` command will fail, if in Samba's mind the queue is not already there. You had promising messages about the:

```
Printer Driver ABC successfully installed.
```

after the **addriver** parts of the procedure? But you are also seeing a disappointing message like this one?

```
result was NT_STATUS_UNSUCCESSFUL
```

It is not good enough that you can see the queue in CUPS, using the **lpstat -p ir85wm** command. A bug in most recent versions of Samba prevents the proper update of the queue-list. The recognition of newly installed CUPS printers fails unless you restart Samba or send a HUP to all `smbd` processes. To verify if this is the reason why Samba does not execute the **setdriver** command successfully, check if Samba “*sees*” the printer:

```
root# rpcclient transmeta -N -U'root%xxxx' -c 'enumprinters 0'|grep ir85wm
      printername:[ir85wm]
```

An alternate command could be this:

```
root# rpcclient transmeta -N -U'root%secret' -c 'getprinter ir85wm'
      cmd = getprinter ir85wm
      flags:[0x800000]
      name:[\\transmeta\ir85wm]
      description:[\\transmeta\ir85wm,ir85wm,DPD]
      comment:[CUPS PostScript-Treiber for Windows NT/200x/XP]
```

By the way, you can use these commands, plus a few more, of course, to install drivers on remote Windows NT print servers too!

19.12 The Printing *.tdb Files

Some mystery is associated with the series of files with a `tdb` suffix appearing in every Samba installation. They are `connections.tdb`, `printing.tdb`, `share_info.tdb`, `ntdrivers.tdb`, `unexpected.tdb`, `brlock.tdb`, `locking.tdb`, `ntforms.tdb`, `messages.tdb`, `ntprinters.tdb`, `sessionid.tdb` and `secrets.tdb`. What is their purpose?

19.12.1 Trivial Database Files

A Windows NT (print) server keeps track of all information needed to serve its duty toward its clients by storing entries in the Windows registry. Client queries are answered by reading from the registry, Administrator or user configuration settings that are saved by writing into the registry. Samba and UNIX obviously do not have such a Registry. Samba instead keeps track of all client related information in a series of `*.tdb` files. (TDB = Trivial Data Base). These are often located in `/var/lib/samba/` or `/var/lock/samba/`. The printing related files are `ntprinters.tdb`, `printing.tdb`, `ntforms.tdb` and `ntdrivers.tdb`.

19.12.2 Binary Format

*.tdb files are not human readable. They are written in a binary format. “*Why not ASCII?*”, you may ask. “*After all, ASCII configuration files are a good and proven tradition on UNIX.*” The reason for this design decision by the Samba team is mainly performance. Samba needs to be fast; it runs a separate **smbd** process for each client connection, in some environments many thousands of them. Some of these smbds might need to write-access the same *.tdb file *at the same time*. The file format of Samba’s *.tdb files allows for this provision. Many smbd processes may write to the same *.tdb file at the same time. This wouldn’t be possible with pure ASCII files.

19.12.3 Losing *.tdb Files

It is very important that all *.tdb files remain consistent over all write and read accesses. However, it may happen that these files *do* get corrupted. (A **kill -9 ‘pidof smbd’** while a write access is in progress could do the damage as well as a power interruption, etc.). In cases of trouble, a deletion of the old printing-related *.tdb files may be the only option. After that you need to re-create all print-related setup or you have made a backup of the *.tdb files in time.

19.12.4 Using tdbbackup

Samba ships with a little utility that helps the root user of your system to backup your *.tdb files. If you run it with no argument, it prints a usage message:

```
root# tdbbackup
Usage: tdbbackup [options] <fname...>

Version:3.0a
  -h          this help message
  -s suffix   set the backup suffix
  -v          verify mode (restore if corrupt)
```

Here is how I backed up my printing.tdb file:

```
root# ls
.          browse.dat      locking.tdb      ntdrivers.tdb   printing.tdb
..         share_info.tdb  connections.tdb  messages.tdb    ntforms.tdb
printing.tdbkp  unexpected.tdb  brlock.tdb      gmon.out        namelist.debug
ntprinters.tdb  sessionid.tdb

root# tdbbackup -s .bak printing.tdb
printing.tdb : 135 records

root# ls -l printing.tdb*
```

```
-rw----- 1 root    root      40960 May  2 03:44 printing.tdb
-rw----- 1 root    root      40960 May  2 03:44 printing.tdb.bak
```

19.13 CUPS Print Drivers from Linuxprinting.org

CUPS ships with good support for HP LaserJet-type printers. You can install the generic driver as follows:

```
root# lpadmin -p laserjet4plus -v parallel:/dev/lp0 -E -m laserjet.ppd
```

The `-m` switch will retrieve the `laserjet.ppd` from the standard repository for not-yet-installed-PPDs, which CUPS typically stores in `/usr/share/cups/model`. Alternately, you may use `-P /path/to/your.ppd`.

The generic `laserjet.ppd`, however, does not support every special option for every LaserJet-compatible model. It constitutes a sort of “*least common denominator*” of all the models. If for some reason you must pay for the commercially available ESP Print Pro drivers, your first move should be to consult the database on the Linuxprinting <http://www.linuxprinting.org/printer_list.cgi> web site. Linuxprinting.org has excellent recommendations about which driver is best used for each printer. Its database is kept current by the tireless work of Till Kamppeter from MandrakeSoft, who is also the principal author of the **foomatic-rip** utility.

NOTE



The former **cupsonomatic** concept is now being replaced by the new successor, a much more powerful **foomatic-rip**. **cupsonomatic** is no longer maintained. Here is the new URL to the Foomatic-3.0 <http://www.linuxprinting.org/driver_list.cgi> database. If you upgrade to **foomatic-rip**, remember to also upgrade to the new-style PPDs for your Foomatic-driven printers. **foomatic-rip** will not work with PPDs generated for the old **cupsonomatic**. The new-style PPDs are 100% compliant to the Adobe PPD specification. They are also intended to be used by Samba and the `cupsaddsmb` utility, to provide the driver files for the Windows clients!

19.13.1 foomatic-rip and Foomatic Explained

Nowadays, most Linux distributions rely on the utilities of Linuxprinting.org to create their printing-related software (which, by the way, works on all UNIXes and on Mac OS X or

Darwin, too). It is not known as well as it should be, that it also has a very end-user-friendly interface that allows for an easy update of drivers and PPDs for all supported models, all spoolers, all operating systems, and all package formats (because there is none). Its history goes back a few years.

Recently, Foomatic has achieved the astonishing milestone of 1000 listed http://www.linuxprinting.org/printer_list.cgi?make=Anyone printer models. Linuxprinting.org keeps all the important facts about printer drivers, supported models and which options are available for the various driver/printer combinations in its Foomatic <http://www.linuxprinting.org/foomatic.html> database. Currently there are 245 drivers http://www.linuxprinting.org/driver_list.cgi in the database. Many drivers support various models, and many models may be driven by different drivers — it's your choice!

19.13.1.1 690 “Perfect” Printers

At present, there are 690 devices dubbed as working perfectly, 181 mostly, 96 partially, and 46 are paperweights. Keeping in mind that most of these are non-PostScript models (PostScript printers are automatically supported by CUPS to perfection, by using their own manufacturer-provided Windows-PPD), and that a multi-functional device never qualifies as working perfectly if it does not also scan and copy and fax under GNU/Linux — then this is a truly astonishing achievement! Three years ago the number was not more than 500, and Linux or UNIX printing at the time wasn't anywhere near the quality it is today.

19.13.1.2 How the Printing HOWTO Started It All

A few years ago Grant Taylor <http://www2.picante.com:81/~gtaylor/> started it all. The roots of today's Linuxprinting.org are in the first Linux Printing HOWTO <http://www.linuxprinting.org/foomatic2.9/howto/> that he authored. As a side-project to this document, which served many Linux users and Admins to guide their first steps in this complicated and delicate setup (to a scientist, printing is “*applying a structured deposition of distinct patterns of ink or toner particles on paper substrates*”, he started to build in a little Postgres database with information about the hardware and driver zoo that made up Linux printing of the time. This database became the core component of today's Foomatic collection of tools and data. In the meantime, it has moved to an XML representation of the data.

19.13.1.3 Foomatic's Strange Name

“*Why the funny name?*” you ask. When it really took off, around spring 2000, CUPS was far less popular than today, and most systems used LPD, LPRng or even PDQ to print. CUPS shipped with a few generic drivers (good for a few hundred different printer models). These didn't support many device-specific options. CUPS also shipped with its own built-in rasterization filter (*psstoraster*, derived from Ghostscript). On the other hand, CUPS provided brilliant support for *controlling* all printer options through standardized and well-defined PPD files (PostScript Printers Description files). Plus, CUPS was designed to be easily extensible.

Taylor already had in his database a respectable compilation of facts about many more printers and the Ghostscript “*drivers*” they run with. His idea, to generate PPDs from the database information and use them to make standard Ghostscript filters work within CUPS, proved to work very well. It also killed several birds with one stone:

- It made all current and future Ghostscript filter developments available for CUPS.
- It made available a lot of additional printer models to CUPS users (because often the traditional Ghostscript way of printing was the only one available).
- It gave all the advanced CUPS options (Web interface, GUI driver configurations) to users wanting (or needing) to use Ghostscript filters.

19.13.1.4 cupsomatic, pdqomatic, lpdomatic, directomatic

CUPS worked through a quickly-hacked up filter script named cupsomatic. `<http://www.linuxprinting.org/download.cgi?filename=cupsomatic&show=0>` cupsomatic ran the printfile through Ghostscript, constructing automatically the rather complicated command line needed. It just needed to be copied into the CUPS system to make it work. To configure the way cupsomatic controls the Ghostscript rendering process, it needs a CUPS-PPD. This PPD is generated directly from the contents of the database. For CUPS and the respective printer/filter combo, another Perl script named CUPS-O-Matic did the PPD generation. After that was working, Taylor implemented within a few days a similar thing for two other spoolers. Names chosen for the config-generator scripts were PDQ-O-Matic `<http://www.linuxprinting.org/download.cgi?filename=lpdomatic&show=0>` (for PDQ) and LPD-O-Matic `<http://www.linuxprinting.org/download.cgi?filename=lpdomatic&show=0>` (for — you guessed it — LPD); the configuration here didn’t use PPDs but other spooler-specific files.

From late summer of that year, Till Kamppeter `<http://www.linuxprinting.org/till/>` started to put work into the database. Kamppeter had been newly employed by Mandrake-Soft `<http://www.mandrakesoft.com/>` to convert its printing system over to CUPS, after they had seen his FLTK `<http://www.fltk.org/>`-based XPP `<http://cups.sourceforge.net/xpp/>` (a GUI front-end to the CUPS lp-command). He added a huge amount of new information and new printers. He also developed the support for other spoolers, like PPR `<http://ppr.sourceforge.net/>` (via ppromatic), GNUlpr `<http://sourceforge.net/projects/lpr/>` and LPRng `<http://www.lprng.org/>` (both via an extended lpdomatic) and spooler-less printing (directomatic `<http://www.linuxprinting.org/download.cgi?filename=directomatic&show=0>`).

So, to answer your question: “*Foomatic*” is the general name for all the overlapping code and data behind the “**omatic*” scripts. Foomatic, up to versions 2.0.x, required (ugly) Perl data structures attached to Linuxprinting.org PPDs for CUPS. It had a different “**omatic*” script for every spooler, as well as different printer configuration files.

19.13.1.5 The *Grand Unification* Achieved

This has all changed in Foomatic versions 2.9 (beta) and released as “*stable*” 3.0. It has now achieved the convergence of all **omatic* scripts and is called the foomatic-rip. `<http://www.linuxprinting.org/foomatic2.9/download.cgi?filename=foomatic-rip&show=0>` This

single script is the unification of the previously different spooler-specific *omatic scripts. foomatic-rip is used by all the different spoolers alike and because it can read PPDs (both the original PostScript printer PPDs and the Linuxprinting.org-generated ones), all of a sudden all supported spoolers can have the power of PPDs at their disposal. Users only need to plug foomatic-rip into their system. For users there is improved media type and source support — paper sizes and trays are easier to configure.

Also, the New Generation of Linuxprinting.org PPDs no longer contains Perl data structures. If you are a distro maintainer and have used the previous version of Foomatic, you may want to give the new one a spin, but remember to generate a new-version set of PPDs via the new foomatic-db-engine! <<http://www.linuxprinting.org/download/foomatic/foomatic-db-engine-3.0.0beta1.tar.gz>> Individual users just need to generate a single new PPD specific to their model by following the steps <<http://www.linuxprinting.org/kpfeifle/LinuxKongress2002/Tutorial/II.Foomatic-User/II.tutorial-handout-foomatic-user.html>> outlined in the Foomatic tutorial or in this chapter. This new development is truly amazing.

foomatic-rip is a very clever wrapper around the need to run Ghostscript with a different syntax, options, device selections, and/or filters for each different printer or spooler. At the same time it can read the PPD associated with a print queue and modify the print job according to the user selections. Together with this comes the 100% compliance of the new Foomatic PPDs with the Adobe spec. Some innovative features of the Foomatic concept may surprise users. It will support custom paper sizes for many printers and will support printing on media drawn from different paper trays within the same job (in both cases, even where there is no support for this from Windows-based vendor printer drivers).

19.13.1.6 Driver Development Outside

Most driver development itself does not happen within Linuxprinting.org. Drivers are written by independent maintainers. Linuxprinting.org just pools all the information and stores it in its database. In addition, it also provides the Foomatic glue to integrate the many drivers into any modern (or legacy) printing system known to the world.

Speaking of the different driver development groups, most of the work is currently done in three projects. These are:

- Omni <<http://www-124.ibm.com/developerworks/oss/linux/projects/omni/>> — a free software project by IBM that tries to convert their printer driver knowledge from good-ol' OS/2 times into a modern, modular, universal driver architecture for Linux/UNIX (still beta). This currently supports 437 models.
- HPIJS <<http://hpinkjet.sf.net/>> — a free software project by HP to provide the support for their own range of models (very mature, printing in most cases is perfect and provides true photo quality). This currently supports 369 models.
- Gimp-Print <<http://gimp-print.sf.net/>> — a free software effort, started by Michael Sweet (also lead developer for CUPS), now directed by Robert Krawitz, which has achieved an amazing level of photo print quality (many Epson users swear that its quality is better than the vendor drivers provided by Epson for the Microsoft platforms). This currently supports 522 models.

19.13.1.7 Forums, Downloads, Tutorials, Howtos — also for Mac OS X and Commercial UNIX

Linuxprinting.org today is the one-stop shop to download printer drivers. Look for printer information and tutorials <<http://www.linuxprinting.org//kpfeifle/LinuxKongress2002/Tutorial/>> or solve printing problems in its popular forums. <<http://www.linuxprinting.org/newsportal/>> This forum it's not just for GNU/Linux users, but admins of commercial UNIX systems <<http://www.linuxprinting.org/macosx/>> are also going there, and the relatively new Mac OS X forum <<http://www.linuxprinting.org/newsportal/thread.php3?name=linuxprinting.macosx.general>> has turned out to be one of the most frequented forums after only a few weeks.

Linuxprinting.org and the Foomatic driver wrappers around Ghostscript are now a standard tool-chain for printing on all the important distros. Most of them also have CUPS underneath. While in recent years most printer data had been added by Kampeter (who works at Mandrake), many additional contributions came from engineers with SuSE, Red Hat, Conectiva, Debian, and others. Vendor-neutrality is an important goal of the Foomatic project.

NOTE



Till Kampeter from MandrakeSoft is doing an excellent job in his spare time to maintain Linuxprinting.org and Foomatic. So if you use it often, please send him a note showing your appreciation.

19.13.1.8 Foomatic Database-Generated PPDs

The Foomatic database is an amazing piece of ingenuity in itself. Not only does it keep the printer and driver information, but it is organized in a way that it can generate PPD files on the fly from its internal XML-based datasets. While these PPDs are modeled to the Adobe specification of PostScript Printer Descriptions (PPDs), the Linuxprinting.org/Foomatic-PPDs do not normally drive PostScript printers. They are used to describe all the bells and whistles you could ring or blow on an Epson Stylus inkjet, or a HP Photosmart, or what-have-you. The main trick is one little additional line, not envisaged by the PPD specification, starting with the **cupsFilter* keyword. It tells the CUPS daemon how to proceed with the PostScript print file (old-style Foomatic-PPDs named the cupsomatic filter script, while the new-style PPDs are now call foomatic-rip). This filter script calls Ghostscript on the host system (the recommended variant is ESP Ghostscript) to do the rendering work. foomatic-rip knows which filter or internal device setting it should ask from Ghostscript to convert the PostScript print job into a raster format ready for the target device. This usage of PPDs to describe the options of non-PS printers was the invention of the CUPS developers. The rest is easy. GUI tools (like KDE's marvelous kprinter, <<http://printing.kde.org/overview/kprinter.phtml>> or the GNOME gtklp, <<http://gtklp.sourceforge.net/>> xpp and the CUPS Web interface) read the PPD as well

and use this information to present the available settings to the user as an intuitive menu selection.

19.13.2 foomatic-rip and Foomatic-PPD Download and Installation

Here are the steps to install a foomatic-rip driven LaserJet 4 Plus-compatible printer in CUPS (note that recent distributions of SuSE, UnitedLinux and Mandrake may ship with a complete package of Foomatic-PPDs plus the **foomatic-rip** utility. Going directly to [Linuxprinting.org](http://linuxprinting.org) ensures that you get the latest driver/PPD files):

- Open your browser at the [Linuxprinting.org printer listpage](http://www.linuxprinting.org/printer_list.cgi). <http://www.linuxprinting.org/printer_list.cgi>
- Check the complete list of printers in the database. <http://www.linuxprinting.org/printer_list.cgi?make=Anyone>.
- Select your model and click on the link.
- You'll arrive at a page listing all drivers working with this model (for all printers, there will always be *one* recommended driver. Try this one first).
- In our case (HP LaserJet 4 Plus), we'll arrive at the default driver for the HP-LaserJet 4 Plus. <http://www.linuxprinting.org/show_printer.cgi?recnum=HP-LaserJet_4_Plus>
- The recommended driver is `ljet4`.
- Several links are provided here. You should visit them all if you are not familiar with the [Linuxprinting.org](http://www.linuxprinting.org) database.
- There is a link to the database page for the `ljet4`. <http://www.linuxprinting.org/show_driver.cgi?driver=ljet4> On the driver's page, you'll find important and detailed information about how to use that driver within the various available spoolers.
- Another link may lead you to the home-page of the driver author or the driver.
- Important links are the ones that provide hints with setup instructions for CUPS <<http://www.linuxprinting.org/cups-doc.html>>, PDQ <<http://www.linuxprinting.org/pdq-doc.html>>, LPD, LPRng and GNUlpr <<http://www.linuxprinting.org/lpd-doc.html>>) as well as PPR <<http://www.linuxprinting.org/ppr-doc.html>> or "*spooler-less*" printing. <<http://www.linuxprinting.org/direct-doc.html>>
- You can view the PPD in your browser through this link: <http://www.linuxprinting.org/ppd-o-matic.cgi?driver=ljet4&printer=HP-LaserJet_4_Plus&show=1>
- Most importantly, you can also generate and download the PPD. <http://www.linuxprinting.org/ppd-o-matic.cgi?driver=ljet4&printer=HP-LaserJet_4_Plus&show=0>
- The PPD contains all the information needed to use our model and the driver; once installed, this works transparently for the user. Later you'll only need to choose resolution, paper size, and so on from the Web-based menu, or from the print dialog GUI, or from the command line.

- If you ended up on the drivers page <http://www.linuxprinting.org/show_driver.cgi?driver=ljet4> you can choose to use the “*PPD-O-Matic*” online PPD generator program.
- Select the exact model and check either **Download** or **Display PPD file** and click **Generate PPD file**.
- If you save the PPD file from the browser view, please do not use cut and paste (since it could possibly damage line endings and tabs, which makes the PPD likely to fail its duty), but use **Save as...** in your browsers menu. (It is best to use the **Download** option directly from the Web page).
- Another interesting part on each driver page is the **Show execution details** button. If you select your printer model and click on that button, a complete Ghostscript command line will be displayed, enumerating all options available for that combination of driver and printer model. This is a great way to “*learn Ghostscript by doing*”. It is also an excellent cheat sheet for all experienced users who need to re-construct a good command line for that damn printing script, but can’t remember the exact syntax.
- Some time during your visit to Linuxprinting.org, save the PPD to a suitable place on your hard-disk, say `/path/to/my-printer.ppd` (if you prefer to install your printers with the help of the CUPS Web interface, save the PPD to the `/usr/share/cups/model/` path and restart cupsd).
- Then install the printer with a suitable command line, like this:

```
root# lpadmin -p laserjet4plus -v parallel:/dev/lp0 -E \  
-P path/to/my-printer.ppd
```

- For all the new-style “*Foomatic-PPDs*” from Linuxprinting.org, you also need a special CUPS filter named `foomatic-rip`.
- The `foomatic-rip` Perl script itself also makes some interesting reading <<http://www.linuxprinting.org/foomatic2.9/download.cgi?filename=foomatic-rip&show=1>> because it is well documented by Kamppeter’s in-line comments (even non-Perl hackers will learn quite a bit about printing by reading it).
- Save `foomatic-rip` either directly in `/usr/lib/cups/filter/foomatic-rip` or somewhere in your `$PATH` (and remember to make it world-executable). Again, do not save by copy and paste but use the appropriate link or the **Save as...** menu item in your browser.
- If you save `foomatic-rip` in your `$PATH`, create a symlink:

```
root# cd /usr/lib/cups/filter/ ; ln -s 'which foomatic-rip'
```

CUPS will discover this new available filter at startup after restarting cupsd.

Once you print to a print queue set up with the Foomatic-PPD, CUPS will insert the appropriate commands and comments into the resulting PostScript jobfile. `foomatic-rip`

is able to read and act upon these and uses some specially encoded Foomatic comments embedded in the jobfile. These in turn are used to construct (transparently for you, the user) the complicated Ghostscript command line telling the printer driver exactly how the resulting raster data should look and which printer commands to embed into the data stream. You need:

- A “*foomatic+something*” PPD — but this is not enough to print with CUPS (it is only *one* important component).
- The *foomatic-rip* filter script (Perl) in `/usr/lib/cups/filters/`.
- Perl to make *foomatic-rip* run.
- Ghostscript (because it is doing the main work, controlled by the PPD/*foomatic-rip* combo) to produce the raster data fit for your printer model’s consumption.
- Ghostscript *must* (depending on the driver/model) contain support for a certain device representing the selected driver for your model (as shown by `gs -h`).
- *foomatic-rip* needs a new version of PPDs (PPD versions produced for *cupsonomatic* do not work with *foomatic-rip*).

19.14 Page Accounting with CUPS

Often there are questions regarding print quotas where Samba users (that is, Windows clients) should not be able to print beyond a certain number of pages or data volume per day, week or month. This feature is dependent on the real print subsystem you’re using. Samba’s part is always to receive the job files from the clients (filtered *or* unfiltered) and hand it over to this printing subsystem.

Of course one could hack things with one’s own scripts. But then there is CUPS. CUPS supports quotas that can be based on the size of jobs or on the number of pages or both, and span any time period you want.

19.14.1 Setting Up Quotas

This is an example command of how root would set a print quota in CUPS, assuming an existing printer named “*quotaprinter*”:

```
root# lpadmin -p quotaprinter -o job-quota-period=604800 \  
-o job-k-limit=1024 -o job-page-limit=100
```

This would limit every single user to print 100 pages or 1024 KB of data (whichever comes first) within the last 604,800 seconds (= 1 week).

19.14.2 Correct and Incorrect Accounting

For CUPS to count correctly, the printfile needs to pass the CUPS `pstops` filter, otherwise it uses a dummy count of “*one*”. Some print files do not pass it (e.g., image files) but

then those are mostly one- page jobs anyway. This also means that proprietary drivers for the target printer running on the client computers and CUPS/Samba, which then spool these files as “*raw*” (i.e., leaving them untouched, not filtering them), will be counted as one-pagers too!

You need to send PostScript from the clients (i.e., run a PostScript driver there) to have the chance to get accounting done. If the printer is a non-PostScript model, you need to let CUPS do the job to convert the file to a print-ready format for the target printer. This is currently working for about a thousand different printer models. Linuxprinting has a driver list. <http://www.linuxprinting.org/printer_list.cgi>

19.14.3 Adobe and CUPS PostScript Drivers for Windows Clients

Before CUPS 1.1.16, your only option was to use the Adobe PostScript Driver on the Windows clients. The output of this driver was not always passed through the **pstops** filter on the CUPS/Samba side, and therefore was not counted correctly (the reason is that it often, depending on the PPD being used, wrote a PJI-header in front of the real PostScript which caused CUPS to skip **pstops** and go directly to the **pstoraster** stage).

From CUPS 1.1.16 onward, you can use the CUPS PostScript Driver for Windows NT/200x/XP clients (which is tagged in the download area of <http://www.cups.org/> as the `cups-samba-1.1.16.tar.gz` package). It does *not* work for Windows 9x/ME clients, but it guarantees:

- To not write a PJI-header.
- To still read and support all PJI-options named in the driver PPD with its own means.
- That the file will pass through the **pstops** filter on the CUPS/Samba server.
- To page-count correctly the print file.

You can read more about the setup of this combination in the man page for **cupsaddsmb** (which is only present with CUPS installed, and only current from CUPS 1.1.16).

19.14.4 The page_log File Syntax

These are the items CUPS logs in the `page_log` for every page of a job:

- Printer name
- User name
- Job ID
- Time of printing
- The page number
- The number of copies
- A billing information string (optional)
- The host that sent the job (included since version 1.1.19)

Here is an extract of my CUPS server's `page_log` file to illustrate the format and included items:

```
tec_IS2027 kurt 401 [22/Apr/2003:10:28:43 +0100] 1 3 #marketing 10.160.50.13
tec_IS2027 kurt 401 [22/Apr/2003:10:28:43 +0100] 2 3 #marketing 10.160.50.13
tec_IS2027 kurt 401 [22/Apr/2003:10:28:43 +0100] 3 3 #marketing 10.160.50.13
tec_IS2027 kurt 401 [22/Apr/2003:10:28:43 +0100] 4 3 #marketing 10.160.50.13
Dig9110 boss 402 [22/Apr/2003:10:33:22 +0100] 1 440 finance-dep 10.160.51.33
```

This was job ID `401`, printed on `tec_IS2027` by user `kurt`, a 64-page job printed in three copies and billed to `#marketing`, sent from IP address `10.160.50.13`. The next job had ID `402`, was sent by user `boss` from IP address `10.160.51.33`, printed from one page 440 copies and is set to be billed to `finance-dep`.

19.14.5 Possible Shortcomings

What flaws or shortcomings are there with this quota system?

- The ones named above (wrongly logged job in case of printer hardware failure, and so on).
- In reality, CUPS counts the job pages that are being processed in *software* (that is, going through the RIP) rather than the physical sheets successfully leaving the printing device. Thus if there is a jam while printing the fifth sheet out of a thousand and the job is aborted by the printer, the page count will still show the figure of a thousand for that job.
- All quotas are the same for all users (no flexibility to give the boss a higher quota than the clerk) and no support for groups.
- No means to read out the current balance or the “*used-up*” number of current quota.
- A user having used up 99 sheets of a 100 quota will still be able to send and print a thousand sheet job.
- A user being denied a job because of a filled-up quota does not get a meaningful error message from CUPS other than “*client-error-not-possible*”.

19.14.6 Future Developments

This is the best system currently available, and there are huge improvements under development for CUPS 1.2:

- Page counting will go into the backends (these talk directly to the printer and will increase the count in sync with the actual printing process; thus, a jam at the fifth sheet will lead to a stop in the counting).
- Quotas will be handled more flexibly.
- Probably there will be support for users to inquire about their accounts in advance.

- Probably there will be support for some other tools around this topic.

19.15 Additional Material

A printer queue with *no* PPD associated to it is a “*raw*” printer and all files will go directly there as received by the spooler. The exceptions are file types *application/octet-stream* that need pass-through feature enabled. “*Raw*” queues do not do any filtering at all, they hand the file directly to the CUPS backend. This backend is responsible for sending the data to the device (as in the “*device URI*” notation: *lpd://*, *socket://*, *smb://*, *ipp://*, *http://*, *parallel://*, *serial://*, *usb://*, and so on).

cupsonomatic/*Foomatic* are *not* native CUPS drivers and they do not ship with CUPS. They are a third party add-on developed at Linuxprinting.org. As such, they are a brilliant hack to make all models (driven by Ghostscript drivers/filters in traditional spoolers) also work via CUPS, with the same (good or bad!) quality as in these other spoolers. *cupsonomatic* is only a vehicle to execute a Ghostscript command-line at that stage in the CUPS filtering chain, where normally the native CUPS *pstoraster* filter would kick in. *cupsonomatic* bypasses *pstoraster*, kidnaps the printfile from CUPS away and redirects it to go through Ghostscript. CUPS accepts this, because the associated *cupsonomatic*/*foomatic*-PPD specifies:

```
*cupsonomaticFilter: "application/vnd.cups-postscript 0 cupsonomatic"
```

This line persuades CUPS to hand the file to *cupsonomatic*, once it has successfully converted it to the MIME type *application/vnd.cups-postscript*. This conversion will not happen for Jobs arriving from Windows that are auto-typed *application/octet-stream*, with the according changes in */etc/cups/mime.types* in place.

CUPS is widely configurable and flexible, even regarding its filtering mechanism. Another workaround in some situations would be to have in */etc/cups/mime.types* entries as follows:

```
application/postscript          application/vnd.cups-raw  0  -
application/vnd.cups-postscript application/vnd.cups-raw  0  -
```

This would prevent all PostScript files from being filtered (rather, they will through the virtual *nullfilter* denoted with “-”). This could only be useful for PS printers. If you want to print PS code on non-PS printers (provided they support ASCII text printing), an entry as follows could be useful:

```
*/*          application/vnd.cups-raw  0  -
```

and would effectively send *all* files to the backend without further processing.

You could have the following entry:

```
application/vnd.cups-postscript application/vnd.cups-raw 0 \
  my_PJL_stripping_filter
```

You will need to write a *my_PJL_stripping_filter* (which could be a shell script) that parses the PostScript and removes the unwanted PjL. This needs to conform to CUPS filter design (mainly, receive and pass the parameters `printrname`, `job-id`, `username`, `jobtitle`, `copies`, `print options` and possibly the filename). It is installed as world executable into `/usr/lib/cups/filters/` and is called by CUPS if it encounters a MIME type *application/vnd.cups-postscript*.

CUPS can handle `-o job-hold-until=indefinite`. This keeps the job in the queue on hold. It will only be printed upon manual release by the printer operator. This is a requirement in many central reproduction departments, where a few operators manage the jobs of hundreds of users on some big machine, where no user is allowed to have direct access (such as when the operators often need to load the proper paper type before running the 10,000 page job requested by marketing for the mailing, and so on).

19.16 Auto-Deletion or Preservation of CUPS Spool Files

Samba print files pass through two spool directories. One is the incoming directory managed by Samba, (set in the `path = /var/spool/samba` directive in the `[printers]` section of `smb.conf`). The other is the spool directory of your UNIX print subsystem. For CUPS it is normally `/var/spool/cups/`, as set by the `cupsd.conf` directive `RequestRoot /var/spool/cups`.

19.16.1 CUPS Configuration Settings Explained

Some important parameter settings in the CUPS configuration file `cupsd.conf` are:

PreserveJobHistory Yes This keeps some details of jobs in `cupsd`'s mind (well it keeps the `c12345`, `c12346`, and so on, files in the CUPS spool directory, which do a similar job as the old-fashioned BSD-LPD control files). This is set to “*Yes*” as a default.

PreserveJobFiles Yes This keeps the job files themselves in `cupsd`'s mind (it keeps the `d12345`, `d12346` etc. files in the CUPS spool directory). This is set to “*No*” as the CUPS default.

“**MaxJobs 500**” This directive controls the maximum number of jobs that are kept in memory. Once the number of jobs reaches the limit, the oldest completed job is automatically purged from the system to make room for the new one. If all of the known jobs are still pending or active, then the new job will be rejected. Setting the maximum to 0 disables this functionality. The default setting is 0.

(There are also additional settings for *MaxJobsPerUser* and *MaxJobsPerPrinter*...)

19.16.2 Pre-Conditions

For everything to work as announced, you need to have three things:

- A Samba-smbd that is compiled against `libcups` (check on Linux by running `ldd 'which smbd'`).
- A `Samba-smb.conf` setting of `printing = cups`.
- Another `Samba-smb.conf` setting of `printcap = cups`.

NOTE



In this case, all other manually set printing-related commands (like `print` command, `lpq` command, `lprm` command, `lppause` command or `lpresume` command) are ignored and they should normally have no influence whatsoever on your printing.

19.16.3 Manual Configuration

If you want to do things manually, replace the `printing = cups` by `printing = bsd`. Then your manually set commands may work (I haven't tested this), and a `print command = lp -d %P %s; rm %s` may do what you need.

19.17 Printing from CUPS to Windows Attached Printers

>From time to time the question arises, how can you print *to* a Windows attached printer *from* Samba? Normally the local connection from Windows host to printer would be done by USB or parallel cable, but this does not matter to Samba. From here only an SMB connection needs to be opened to the Windows host. Of course, this printer must be shared first. As you have learned by now, CUPS uses *backends* to talk to printers and other servers. To talk to Windows shared printers, you need to use the `smb` (surprise, surprise!) backend. Check if this is in the CUPS backend directory. This usually resides in `/usr/lib/cups/backend/`. You need to find an `smb` file there. It should be a symlink to `smbspool` and the file must exist and be executable:

```
root# ls -l /usr/lib/cups/backend/
total 253
drwxr-xr-x  3 root  root    720 Apr 30 19:04 .
drwxr-xr-x  6 root  root   125 Dec 19 17:13 ..
-rwxr-xr-x  1 root  root 10692 Feb 16 21:29 canon
-rwxr-xr-x  1 root  root 10692 Feb 16 21:29 epson
lrwxrwxrwx  1 root  root     3 Apr 17 22:50 http -> ipp
-rwxr-xr-x  1 root  root 17316 Apr 17 22:50 ipp
```

```
-rwxr-xr-x  1 root  root  15420 Apr 20 17:01 lpd
-rwxr-xr-x  1 root  root   8656 Apr 20 17:01 parallel
-rwxr-xr-x  1 root  root   2162 Mar 31 23:15 pdfdistiller
lrwxrwxrwx  1 root  root    25 Apr 30 19:04 ptal -> /usr/sbin/ptal-cups
-rwxr-xr-x  1 root  root   6284 Apr 20 17:01 scsi
lrwxrwxrwx  1 root  root    17 Apr  2 03:11 smb -> /usr/bin/smbpool
-rwxr-xr-x  1 root  root   7912 Apr 20 17:01 socket
-rwxr-xr-x  1 root  root   9012 Apr 20 17:01 usb
```

```
root# ls -l 'which smbpool'
-rwxr-xr-x  1 root  root 563245 Dec 28 14:49 /usr/bin/smbpool
```

If this symlink does not exist, create it:

```
root# ln -s 'which smbpool' /usr/lib/cups/backend/smb
```

smbpool has been written by Mike Sweet from the CUPS folks. It is included and ships with Samba. It may also be used with print subsystems other than CUPS, to spool jobs to Windows printer shares. To set up printer *winprinter* on CUPS, you need to have a driver for it. Essentially this means to convert the print data on the CUPS/Samba host to a format that the printer can digest (the Windows host is unable to convert any files you may send). This also means you should be able to print to the printer if it were hooked directly at your Samba/CUPS host. For troubleshooting purposes, this is what you should do to determine if that part of the process chain is in order. Then proceed to fix the network connection/authentication to the Windows host, and so on.

To install a printer with the *smb* backend on CUPS, use this command:

```
root# lpadmin -p winprinter -v smb://WINDOWSNETBIOSNAME/printersharename \
  -P /path/to/PPD
```

The PPD must be able to direct CUPS to generate the print data for the target model. For PostScript printers, just use the PPD that would be used with the Windows NT PostScript driver. But what can you do if the printer is only accessible with a password? Or if the printer's host is part of another workgroup? This is provided for: You can include the required parameters as part of the *smb://* device-URI like this:

- *smb://WORKGROUP/WINDOWSNETBIOSNAME/printersharename*
- *smb://username:password@WORKGROUP/WINDOWSNETBIOSNAME/printersharename*
- *smb://username:password@WINDOWSNETBIOSNAME/printersharename*

Note that the device-URI will be visible in the process list of the Samba server (e.g., when someone uses the **ps -aux** command on Linux), even if the username and passwords are sanitized before they get written into the log files. So this is an inherently insecure option, however, it is the only one. Don't use it if you want to protect your passwords. Better share the printer in a way that does not require a password! Printing will only work if you have a

working netbios name resolution up and running. Note that this is a feature of CUPS and you do not necessarily need to have `smbd` running.

19.18 More CUPS-Filtering Chains

The following diagrams reveal how CUPS handles print jobs.

CUPS in and of itself has this (general) filter chain (italic letters are file-formats or MIME types, other are filters (this is true for pre-1.1.15 of pre-4.3 versions of CUPS and ESP PrintPro):

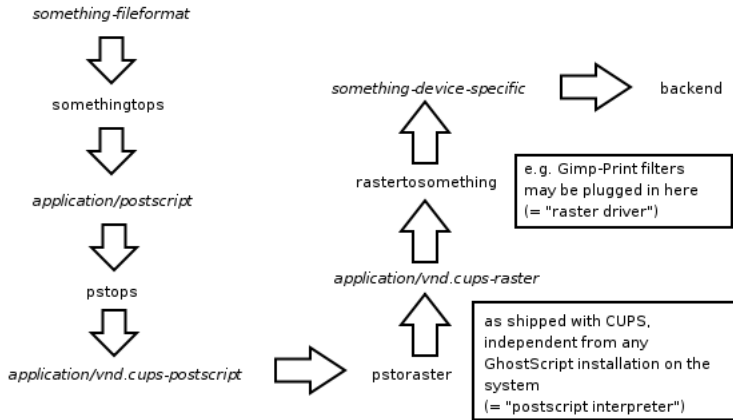

ESP PrintPro has some enhanced "rastertosomething" filters as compared to CUPS, and also a somewhat improved "pstoraster" filter.

NOTE: Gimp-Print and some other 3rd-Party-Filters (like TurboPrint) to CUPS and ESP PrintPro plug-in where rastertosomething is noted.

Figure 19.17. Filtering chain 1.

19.19 Common Errors

19.19.1 Windows 9x/ME Client Can't Install Driver

For Windows 9x/ME, clients require the printer names to be eight characters (or "8 plus 3 chars suffix") max; otherwise, the driver files will not get transferred when you want to download them from Samba.

19.19.2 "`cupsaddsmb`" Keeps Asking for Root Password in Never-ending Loop

Have you `security = user`? Have you used `smbpasswd` to give root a Samba account? You can do two things: open another terminal and execute `smbpasswd -a root` to create the account and continue entering the password into the first terminal. Or break out of the loop by pressing ENTER twice (without trying to type a password).

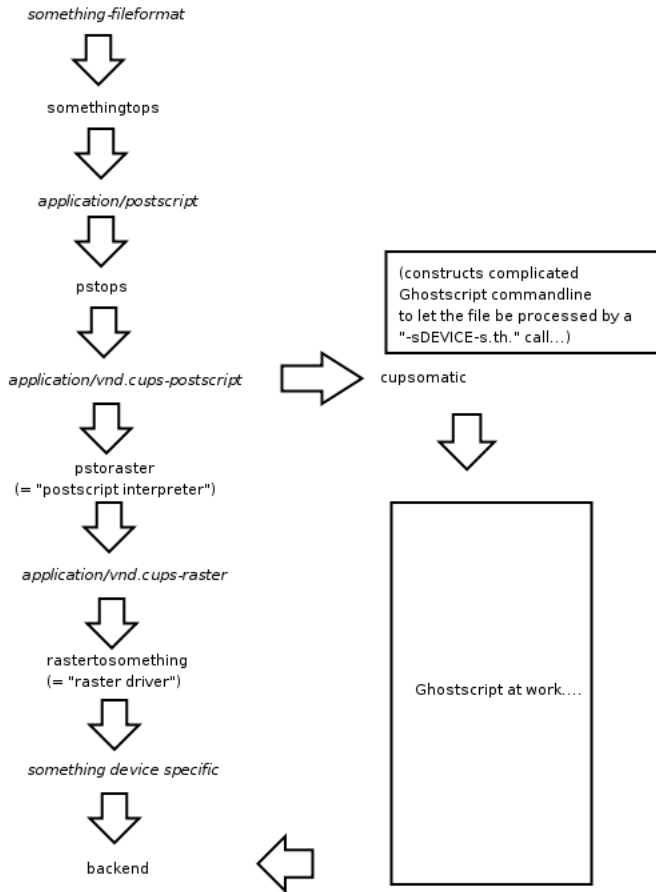

Note, that cupsomatic "kidnaps" the printfile after the application/vnd.cups-postscript stage and deviates it gh the CUPS-external, systemwide Ghostscript installation, bypassing the "pstoraster" filter (therefore also bypassing the CUPS-raster-drivers "rastertosomething", and hands the rasterized file directly to the CUPS backend...

cupsomatic is not made by the CUPS developers. It is an independent contribution to printing development, made by people from Linuxprinting.org. (see also <http://www.cups.org/cups-help.html>)

Figure 19.18. Filtering chain with cupsomatic

If the error is: *"tree connect failed: NT_STATUS_BAD_NETWORK_NAME"*, you may have forgotten to create the `/etc/samba/drivers` directory.

19.19.3 "cupsaddsmb" Errors

The use of *"cupsaddsmb"* gives *"No PPD file for printer..."* Message While PPD File Is Present. What might the problem be?

Have you enabled printer sharing on CUPS? This means: Do you have a `<Location /printers>...</Location>` section in CUPS server's `cupsd.conf` that does not deny access to the host you run “`cupsaddsmb`” from? It *could* be an issue if you use `cupsaddsmb` remotely, or if you use it with a `-h` parameter: `cupsaddsmb -H sambaserver -h cupsserver -v printername`.

Is your `TempDir` directive in `cupsd.conf` set to a valid value and is it writable?

19.19.4 Client Can't Connect to Samba Printer

Use `smbstatus` to check which user you are from Samba's point of view. Do you have the privileges to write into the `[print$]` share?

19.19.5 New Account Reconnection from Windows 200x/XP Troubles

Once you are connected as the wrong user (for example, as `nobody`, which often occurs if you have `map to guest = bad user`), Windows Explorer will not accept an attempt to connect again as a different user. There will not be any byte transferred on the wire to Samba, but still you'll see a stupid error message that makes you think Samba has denied access. Use `smbstatus` to check for active connections. Kill the PIDs. You still can't reconnect and you get the dreaded **You can't connect with a second account from the same machine** message, as soon as you are trying. And you do not see any single byte arriving at Samba (see logs; use “*ethereal*”) indicating a renewed connection attempt. Shut all Explorer Windows. This makes Windows forget what it has cached in its memory as established connections. Then reconnect as the right user. The best method is to use a DOS terminal window and *first* do `net use z: \\GANDALF\print$ /user:root`. Check with `smbstatus` that you are connected under a different account. Now open the **Printers** folder (on the Samba server in the **Network Neighborhood**), right-click on the printer in question and select **Connect...**

19.19.6 Avoid Being Connected to the Samba Server as the Wrong User

You see per `smbstatus` that you are connected as user `nobody`; while you want to be `root` or printer admin. This is probably due to `map to guest = bad user`, which silently connects you under the `guest` account when you gave (maybe by accident) an incorrect username. Remove `map to guest`, if you want to prevent this.

19.19.7 Upgrading to CUPS Drivers from Adobe Drivers

This information came from a mailing list posting regarding problems experienced when upgrading from Adobe drivers to CUPS drivers on Microsoft Windows NT/200x/XP Clients.

First delete all old Adobe-using printers. Then delete all old Adobe drivers. (On Windows 200x/XP, right-click in the background of **Printers** folder, select **Server Properties...**, select tab **Drivers** and delete here).

19.19.8 Can't Use "*cupsaddsmb*" on Samba Server Which Is a PDC

Do you use the "*naked*" root user name? Try to do it this way: `cupsaddsmb -U DOMAINNAME\root -v printername>` (note the two backslashes: the first one is required to "*escape*" the second one).

19.19.9 Deleted Windows 200x Printer Driver Is Still Shown

Deleting a printer on the client will not delete the driver too (to verify, right-click on the white background of the **Printers** folder, select **Server Properties** and click on the **Drivers** tab). These same old drivers will be re-used when you try to install a printer with the same name. If you want to update to a new driver, delete the old ones first. Deletion is only possible if no other printer uses the same driver.

19.19.10 Windows 200x/XP "Local Security Policies"

Local Security Policies may not allow the installation of unsigned drivers. "*Local Security Policies*" may not allow the installation of printer drivers at all.

19.19.11 Administrator Cannot Install Printers for All Local Users

Windows XP handles SMB printers on a "*per-user*" basis. This means every user needs to install the printer himself. To have a printer available for everybody, you might want to use the built-in IPP client capabilities of Win XP. Add a printer with the print path of `http://cupsserver:631/printers/printername`. We're still looking into this one. Maybe a logon script could automatically install printers for all users.

19.19.12 Print Change Notify Functions on NT-clients

For print change, notify functions on NT++ clients. These need to run the **Server** service first (renamed to **File & Print Sharing for MS Networks** in XP).

19.19.13 Win XP-SP1

Win XP-SP1 introduced a Point and Print Restriction Policy (this restriction does not apply to "*Administrator*" or "*Power User*" groups of users). In Group Policy Object Editor, go to **User Configuration** -> **Administrative Templates** -> **Control Panel** -> **Printers**. The policy is automatically set to **Enabled** and the **Users can only Point and Print to machines in their Forest**. You probably need to change it to **Disabled** or **Users can only Point and Print to these servers** to make driver downloads from Samba possible.

19.19.14 Print Options for All Users Can't Be Set on Windows 200x/XP

How are you doing it? I bet the wrong way (it is not easy to find out, though). There are three different ways to bring you to a dialog that *seems* to set everything. All three dialogs

look the same, yet only one of them does what you intend. You need to be Administrator or Print Administrator to do this for all users. Here is how I do in on XP:

A The first wrong way:

- (a) Open the **Printers** folder.
- (b) Right-click on the printer (**remotepri nter on cupshost**) and select in context menu **Printing Preferences...**
- (c) Look at this dialog closely and remember what it looks like.

B The second wrong way:

- (a) Open the **Printers** folder.
- (b) Right-click on the printer (**remotepri nter on cupshost**) and select the context menu **Properties**.
- (c) Click on the **General** tab.
- (d) Click on the button **Printing Preferences...**
- (e) A new dialog opens. Keep this dialog open and go back to the parent dialog.

C The third, and the correct way:

- (a) Open the **Printers** folder.
- (b) Click on the **Advanced** tab. (If everything is “grayed out,” then you are not logged in as a user with enough privileges).
- (c) Click on the **Printing Defaults...** button.
- (d) On any of the two new tabs, click on the **Advanced...** button.
- (e) A new dialog opens. Compare this one to the other identical looking one from “B.5” or A.3”.

Do you see any difference? I don’t either. However, only the last one, which you arrived at with steps “C.1.-6.”, will save any settings permanently and be the defaults for new users. If you want all clients to get the same defaults, you need to conduct these steps *as Administrator* (printer admin in `smb.conf`) *before* a client downloads the driver (the clients can later set their own *per-user defaults* by following the procedures A or B above).

19.19.15 Most Common Blunders in Driver Settings on Windows Clients

Don’t use *Optimize for Speed*, but use *Optimize for Portability* instead (Adobe PS Driver). Don’t use *Page Independence: No*; always settle with *Page Independence: Yes* (Microsoft PS Driver and CUPS PS Driver for Windows NT/200x/XP). If there are problems with fonts, use *Download as Softfont into printer* (Adobe PS Driver). For **TrueType Download Options** choose *Outline*. Use PostScript Level 2, if you are having trouble with a non-PS printer and if there is a choice.

19.19.16 cupsaddsmb Does Not Work with Newly Installed Printer

Symptom: The last command of **cupsaddsmb** does not complete successfully: **cmd = setdriver printername printername** result was `NT_STATUS_UNSUCCESSFUL` then possibly the printer was not yet recognized by Samba. Did it show up in Network Neighborhood? Did it show up in `rpcclient hostname -c 'enumprinters'`? Restart `smbd` (or send a **kill -HUP** to all processes listed by `smbstatus` and try again.

19.19.17 Permissions on /var/spool/samba/ Get Reset After Each Reboot

Have you ever by accident set the CUPS spool directory to the same location? (*RequestRoot /var/spool/samba/* in `cupsd.conf` or the other way round: `/var/spool/cups/` is set as `path` in the `[printers]` section). These *must* be different. Set *RequestRoot /var/spool/cups/* in `cupsd.conf` and `path = /var/spool/samba` in the `[printers]` section of `smb.conf`. Otherwise `cupsd` will sanitize permissions to its spool directory with each restart and printing will not work reliably.

19.19.18 Print Queue Called “lp” Mis-handles Print Jobs

In this case a print queue called “*lp*” intermittently swallows jobs and spits out completely different ones from what was sent.

It is a bad idea to name any printer “*lp*”. This is the traditional UNIX name for the default printer. CUPS may be set up to do an automatic creation of Implicit Classes. This means, to group all printers with the same name to a pool of devices, and load-balancing the jobs across them in a round-robin fashion. Chances are high that someone else has a printer named “*lp*” too. You may receive his jobs and send your own to his device unwittingly. To have tight control over the printer names, set *BrowseShortNames No*. It will present any printer as *printername@cupshost* and then gives you better control over what may happen in a large networked environment.

19.19.19 Location of Adobe PostScript Driver Files for “cupsaddsmb”

Use `smbclient` to connect to any Windows box with a shared PostScript printer: `smbclient //windowsbox/print/$ -U guest`. You can navigate to the `W32X86/2` subdir to `mget ADOBE*` and other files or to `WIN40/0` to do the same. Another option is to download the `*.exe` packaged files from the Adobe Web site.

19.20 Overview of the CUPS Printing Processes

A complete overview of the CUPS printing processes can be found in the next flowchart.

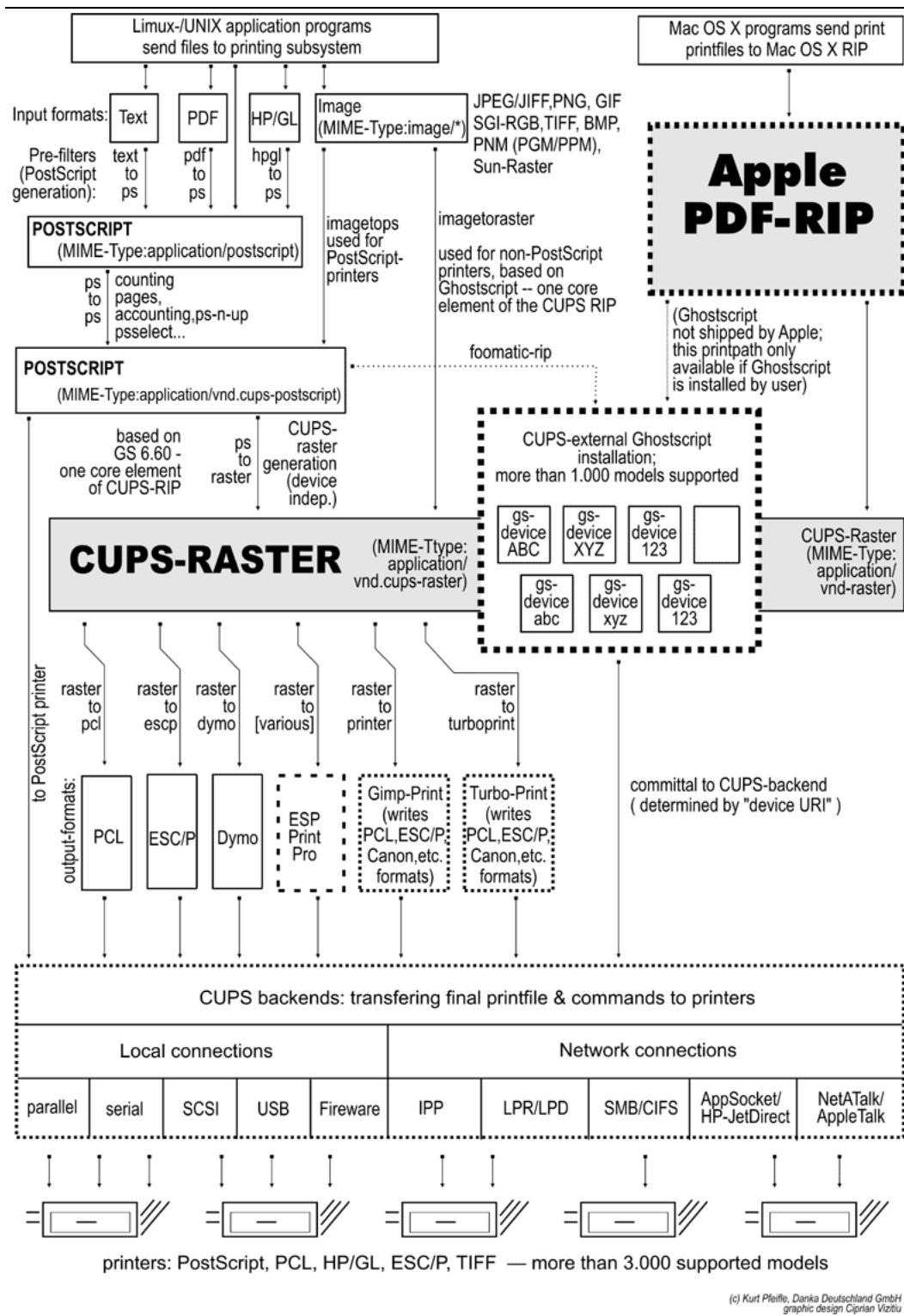

(c) Kurt Pfeifle, Danka Deutschland GmbH graphic design Ciprian Vizitru

Figure 19.19. CUPS printing overview.

STACKABLE VFS MODULES

20.1 Features and Benefits

Since Samba-3, there is support for stackable VFS (Virtual File System) modules. Samba passes each request to access the UNIX file system through the loaded VFS modules. This chapter covers all the modules that come with the Samba source and references to some external modules.

20.2 Discussion

If not supplied with your platform distribution binary Samba package you may have problems compiling these modules, as shared libraries are compiled and linked in different ways on different systems. They currently have been tested against GNU/Linux and IRIX.

To use the VFS modules, create a share similar to the one below. The important parameter is the `vfs objects` parameter where you can list one or more VFS modules by name. For example, to log all access to files and put deleted files in a recycle bin, see next configuration:

Example 20.2.1. smb.conf with VFS modules

```
[audit]
comment = Audited /data directory
path = /data
vfs objects = audit recycle
writable = yes
browseable = yes
```

The modules are used in the order in which they are specified. Let's say that you want to both have a virus scanner module and a recycle bin module. It is wise to put the virus scanner module as the first one so that it is the first that get run and may detect a virus immediately, before any action is performed on that file. `vfs objects = vscan-clamav recycle`

Samba will attempt to load modules from the `/lib` directory in the root directory of the Samba installation (usually `/usr/lib/samba/vfs` or `/usr/local/samba/lib/vfs`).

Some modules can be used twice for the same share. This can be done using a configuration similar to the one shown in the following example.

Example 20.2.2. `smb.conf` with multiple VFS modules

```
[test]
    comment = VFS TEST
    path = /data
    writeable = yes
    browseable = yes
    vfs objects = example:example1 example example:test
    example1: parameter = 1
    example: parameter = 5
    test: parameter = 7
```

20.3 Included Modules

20.3.1 audit

A simple module to audit file access to the syslog facility. The following operations are logged:

- share
- connect/disconnect
- directory opens/create/remove
- file open/close/rename/unlink/chmod

20.3.2 extd.audit

This module is identical with the **audit** module above except that it sends audit logs to both syslog as well as the **smbd** log files. The log level for this module is set in the `smb.conf` file.

Valid settings and the information that will be recorded are shown in the next table.

20.3.2.1 Configuration of Auditing

This auditing tool is more flexible than most people readily will recognize. There are a number of ways by which useful logging information can be recorded.

- Syslog can be used to record all transaction. This can be disabled by setting in the `smb.conf` file `syslog = 0`.

Table 20.1. Extended Auditing Log Information

Log Level	Log Details - File and Directory Operations
0	Make Directory, Remove Directory, Unlink
1	Open Directory, Rename File, Change Permissions/ACLs
2	Open & Close File
10	Maximum Debug Level

- Logging can take place to the default log file (`log.smbd`) for all loaded VFS modules just by setting in the `smb.conf` file `log level = 0 vfs:x`, where `x` is the log level. This will disable general logging while activating all logging of VFS module activity at the log level specified.
- Detailed logging can be obtained per user, per client machine, etc. This requires the above together with the creative use of the `log file` settings.

An example of detailed per-user and per-machine logging can be obtained by setting `log level = /var/log/samba/%U.%m.log`.

Auditing information often must be preserved for a long time. So that the log files do not get rotated it is essential that the `max log size = 0` be set in the `smb.conf` file.

20.3.3 fake_perms

This module was created to allow Roaming Profile files and directories to be set (on the Samba server under UNIX) as read only. This module will, if installed on the Profiles share, report to the client that the Profile files and directories are writeable. This satisfies the client even though the files will never be overwritten as the client logs out or shuts down.

20.3.4 recycle

A Recycle Bin-like module. Where used, unlink calls will be intercepted and files moved to the recycle directory instead of being deleted. This gives the same effect as the **Recycle Bin** on Windows computers.

The **Recycle Bin** will not appear in Windows Explorer views of the network file system (share) nor on any mapped drive. Instead, a directory called `.recycle` will be automatically created when the first file is deleted. Users can recover files from the `.recycle` directory. If the `recycle:keeptree` has been specified, deleted files will be found in a path identical with that from which the file was deleted.

Supported options for the **recycle** module are as follow:

recycle:repository Relative path of the directory where deleted files should be moved.

recycle:keeptree Specifies whether the directory structure should be kept or if the files in the directory that is being deleted should be kept separately in the recycle bin.

recycle:versions If this option is set, two files with the same name that are deleted will both be kept in the recycle bin. Newer deleted versions of a file will be called “*Copy #x of filename*”.

recycle:touch Specifies whether a file’s access date should be touched when the file is moved to the recycle bin.

recycle:maxsize Files that are larger than the number of bytes specified by this parameter will not be put into the recycle bin.

recycle:exclude List of files that should not be put into the recycle bin when deleted, but deleted in the regular way.

recycle:exclude_dir Contains a list of directories. When files from these directories are deleted, they are not put into the recycle bin but are deleted in the regular way.

recycle:noversions Specifies a list of paths (wildcards such as * and ? are supported) for which no versioning should be used. Only useful when *recycle:versions* is enabled.

20.3.5 netatalk

A netatalk module will ease co-existence of Samba and netatalk file sharing services.

Advantages compared to the old netatalk module:

- Does not care about creating .AppleDouble forks, just keeps them in sync.
- If a share in `smb.conf` does not contain .AppleDouble item in hide or veto list, it will be added automatically.

20.3.6 shadow_copy

WARNING

THIS IS NOT A BACKUP, ARCHIVAL, OR VERSION CONTROL SOLUTION!

With Samba or Windows servers, shadow copy is designed to be an end-user tool only. It does not replace or enhance your backup and archival solutions and should in no way be considered as such. Additionally, if you need version control, implement a version control system. You have been warned.

The `shadow_copy` module allows you to setup functionality that is similar to MS shadow copy services. When setup properly, this module allows Microsoft shadow copy clients to browse "shadow copies" on samba shares. You will need to install the shadow copy client. You can get the MS shadow copy client here. <<http://www.microsoft.com/windowsserver2003/downloads/shadowcopyclient.msp>>. Note the additional requirements for pre-Windows XP clients. I did not test this functionality with any pre-Windows XP clients. You should be able to get more information about MS Shadow Copy from the Microsoft's site <<http://www.microsoft.com/windowsserver2003/techinfo/overview/scr.msp>>.

The `shadow_copy` VFS module requires some underlying file system setup with some sort of Logical Volume Manager (LVM) such as LVM1, LVM2, or EVMS. Setting up LVM is beyond the scope of this document; however, we will outline the steps we took to test this functionality for *example purposes only*. You need to make sure the LVM implementation you choose to deploy is ready for production. Make sure you do plenty of tests.

Here are some common resources for LVM and EVMS:

- Sistina's LVM1 and LVM2 <http://www.sistina.com/products_lvm_download.htm>
- Enterprise Volume Management System (EVMS) <<http://evms.sourceforge.net/>>
- The LVM HOWTO <<http://tldp.org/HOWTO/LVM-HOWTO/>>
- See Learning Linux LVM, Part 1 <<http://www-106.ibm.com/developerworks/linux/library/1-lvm/>> and Learning Linux LVM, Part 2 <<http://www-106.ibm.com/developerworks/library/1-lvm2.html>> for Daniel Robbins' well written a two part tutorial on Linux and LVM using LVM source code and reiserfs.

20.3.6.1 Shadow Copy Setup

At the time of this writing, not much testing has been done. I tested the shadow copy VFS module with a specific scenario which was not deployed in a production environment, but more as a proof of concept. The scenario involved a Samba 3 file server on Debian Sarge with an XFS file system and LVM1. I do NOT recommend you use this as a solution without doing your own due diligence with regard to all the components presented here. That said, following is an basic outline of how I got things going.

1. **Installed Operating System.** In my tests, I used Debian Sarge <<http://www.debian.org/devel/debian-installer/>> (i.e. testing) on an XFS file system. Setting up the OS is a bit beyond the scope of this document. It is assumed that you have a working OS capable of running Samba.
2. **Install & Configure Samba.** See the installation section of this HOWTO for more detail on this. It doesn't matter if it is a Domain Controller or Member File Server, but it is assumed that you have a working Samba 3.0.3 or newer server running.
3. **Install & Configure LVM.** Before you can make shadow copies available to the client, you have to create the shadow copies. This is done by taking some sort of file system snapshot. Snapshots are a typical feature of Logical Volume Managers such as LVM, so we first need to have that setup.

The following is provided as an example and will be most helpful for Debian users. Again, this was tested using the "testing" or "Sarge" distribution.

- Install `lvm10` and `devfsd` packages if you have not done so already. On Debian systems, you are warned of the interaction of `devfs` and `lvm1` which requires the use of `devfs` filenames. Running **`apt-get update && apt-get install lvm10 devfsd xfsprogs`** should do the trick for this example.
- Now you need to create a volume. You will need to create a partition (or partitions) to add to your volume. Use your favorite partitioning tool (e.g. Linux `fdisk`, `cdisk`, etc.). The partition type should be set to `0x8e` for "Linux LVM." In this example, we will use `/dev/hdb1`.

Once you have the Linux LVM partition (type `0x8e`), you can run a series of commands to create the LVM volume. You can use several disks and or partitions, but we will use only one in this example. You may also need to load the kernel module with something like **`modprobe lvm-mod`** and set your system up to load it on reboot by adding it to (`/etc/modules`).

- Create the physical volume with **`pvcreate /dev/hdb1`**
- Create the volume group with and add `/dev/hda1` to it with **`vgcreate shadowvol /dev/hdb1`**

You can use **`vgdisplay`** to review information about the volume group.

- Now you can create the logical volume with something like **`lvcreate -L400M -nsh_test shadowvol`**

This creates the logical volume of 400MB's named "sh_test" in the volume group we created called `shadowvol`. If everything is working so far, you should see them in `/dev/shadowvol1`.

- Now we should be ready to format the logical volume we named `sh_test` with **`mkfs.xfs /dev/shadowvol/sh_test`**

You can format the logical volume with any file system you choose, but make sure to use one that allows you to take advantage of the additional features of LVM such as freezing, resizing and growing your file systems.

Now we have an LVM volume where we can play with the `shadow_copy` VFS module.

- Now we need to prepare the directory with something like **`mkdir -p /data/shadow_share`** or whatever you want to name your shadow copy enabled Samba share. Make sure you set the permissions such that you can use it. If in doubt, use **`chmod 777 /data/shadow_share`** and tighten the permissions once you get things working.
- Mount the LVM volume using something like **`mount /dev/shadowvol/sh_test /data/shadow_share`**

You may also want to edit your `/etc/fstab` so that this partition mounts during the system boot.

4. **Install & Configure the shadow_copy VFS Module.** Finally we get to the actual `shadow_copy` VFS module. The `shadow_copy` VFS module should be available in Samba 3.0.3 and higher. The `smb.conf` configuration is pretty standard. Here is our example of a share configured with the `shadow_copy` VFS module:

Example 20.3.1. Share With shadow_copy VFS

```
[shadow_share]
    comment = Shadow Copy Enabled Share
    path = /data/shadow_share
    vfs objects = shadow_copy
    writeable = yes
    browseable = yes
```

- 5. Create Snapshots and Make Them Available to shadow_copy.so.** Before you can browse the shadow copies, you must create them and mount them. This will most likely be done with a script that runs as a cron job. With this particular solution, the shadow_copy VFS module is used to browse LVM snapshots. Those snapshots are not created by the module. They are not made available by the module either. This module allows the shadow copy enabled client to browse the snapshots you take and make available.

Here is a simple script used to create and mount the snapshots:

```
#!/bin/bash
# This is a test, this is only a test
SNAPNAME='date +%Y.%m.%d-%H.%M.%S'
xfs_freeze -f /data/shadow_share/
lvcreate -L10M -s -n $SNAPNAME /dev/shadowvol/sh_test
xfs_freeze -u /data/shadow_share/
mkdir /data/shadow_share/@GMT-$SNAPNAME
mount /dev/shadowvol/$SNAPNAME /data/shadow_share/@GMT-$SNAPNAME -onouuid,ro
```

Note that the script does not handle other things like remounting snapshots on reboot.

- 6. Test From Client.** To test, you will need to install the shadow copy client which you can obtain from the Microsoft web site. <<http://www.microsoft.com/windowsserver2003/downloads/shadowcopyclient.mspx>> I only tested this with an XP client so your results may vary with other pre-XP clients. Once installed, with your XP client you can right-click on specific files or in the empty space of the shadow_share and view the "properties". If anything has changed, then you will see it on the "Previous Versions" tab of the properties window.

20.4 VFS Modules Available Elsewhere

This section contains a listing of various other VFS modules that have been posted but do not currently reside in the Samba CVS tree for one reason or another (e.g., it is easy for the maintainer to have his or her own CVS tree).

No statements about the stability or functionality of any module should be implied due to its presence here.

20.4.1 DatabaseFS

URL: <<http://www.css.tayloru.edu/~elorimer/databasefs/index.php>>

By Eric Lorimer. <<mailto:elorimer@css.tayloru.edu>>

I have created a VFS module that implements a fairly complete read-only filesystem. It presents information from a database as a filesystem in a modular and generic way to allow different databases to be used (originally designed for organizing MP3s under directories such as “*Artists*,” “*Song Keywords*,” and so on. I have since easily applied it to a student roster database.) The directory structure is stored in the database itself and the module makes no assumptions about the database structure beyond the table it requires to run.

Any feedback would be appreciated: comments, suggestions, patches, and so on. If nothing else, hopefully it might prove useful for someone else who wishes to create a virtual filesystem.

20.4.2 vscan

URL: <<http://www.openantivirus.org/projects.php#samba-vscan>>

samba-vscan is a proof-of-concept module for Samba, which provides on-access anti-virus support for files shared using Samba. samba-vscan supports various virus scanners and is maintained by Rainer Link.

WINBIND: USE OF DOMAIN ACCOUNTS

21.1 Features and Benefits

Integration of UNIX and Microsoft Windows NT through a unified logon has been considered a “*holy grail*” in heterogeneous computing environments for a long time.

There is one other facility without which UNIX and Microsoft Windows network interoperability would suffer greatly. It is imperative that there be a mechanism for sharing files across UNIX systems and to be able to assign domain user and group ownerships with integrity.

winbind is a component of the Samba suite of programs that solves the unified logon problem. Winbind uses a UNIX implementation of Microsoft RPC calls, Pluggable Authentication Modules, and the Name Service Switch to allow Windows NT domain users to appear and operate as UNIX users on a UNIX machine. This chapter describes the Winbind system, explaining the functionality it provides, how it is configured, and how it works internally.

Winbind provides three separate functions:

- Authentication of user credentials (via PAM).
- Identity resolution (via NSS).
- Winbind maintains a database called `winbind_idmap.tdb` in which it stores mappings between UNIX UIDs / GIDs and NT SIDs. This mapping is used only for users and groups that do not have a local UID/GID. It stores the UID/GID allocated from the `idmap uid/gid` range that it has mapped to the NT SID. If *idmap backend* has been specified as `ldapsam:url` then instead of using a local mapping Winbind will obtain this information from the LDAP database.

NOTE



If **winbindd** is not running, **smbd** (which calls **winbindd**) will fall back to using purely local information from `/etc/passwd` and `/etc/group` and no dynamic mapping will be used.

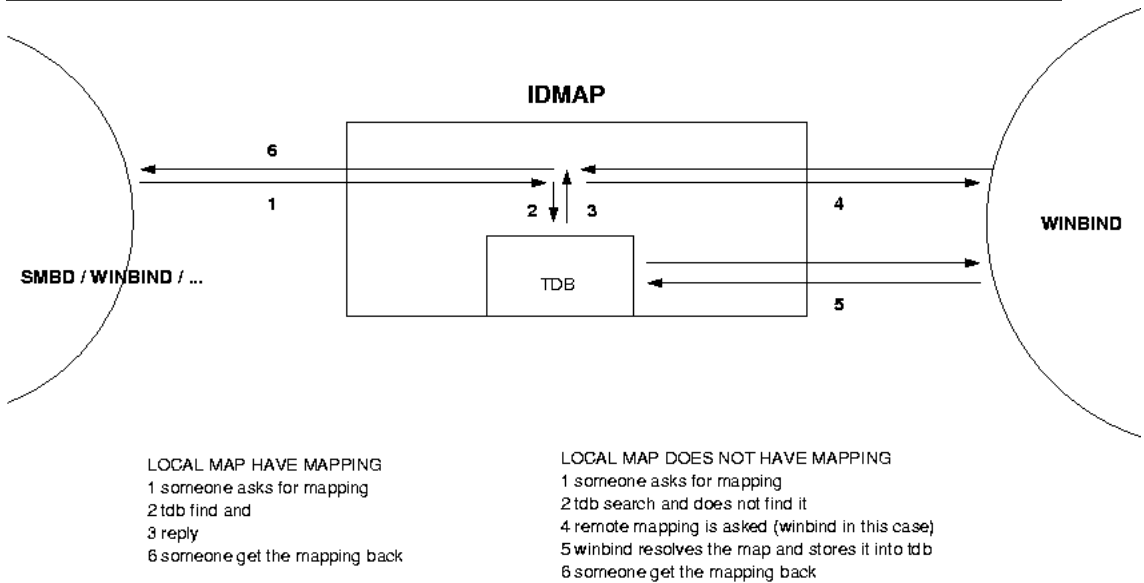

Figure 21.1. Winbind Idmap

21.2 Introduction

It is well known that UNIX and Microsoft Windows NT have different models for representing user and group information and use different technologies for implementing them. This fact has made it difficult to integrate the two systems in a satisfactory manner.

One common solution in use today has been to create identically named user accounts on both the UNIX and Windows systems and use the Samba suite of programs to provide file and print services between the two. This solution is far from perfect, however, as adding and deleting users on both sets of machines becomes a chore and two sets of passwords are required — both of which can lead to synchronization problems between the UNIX and Windows systems and confusion for users.

We divide the unified logon problem for UNIX machines into three smaller problems:

- Obtaining Windows NT user and group information.
- Authenticating Windows NT users.

- Password changing for Windows NT users.

Ideally, a prospective solution to the unified logon problem would satisfy all the above components without duplication of information on the UNIX machines and without creating additional tasks for the system administrator when maintaining users and groups on either system. The Winbind system provides a simple and elegant solution to all three components of the unified logon problem.

21.3 What Winbind Provides

Winbind unifies UNIX and Windows NT account management by allowing a UNIX box to become a full member of an NT domain. Once this is done the UNIX box will see NT users and groups as if they were “*native*” UNIX users and groups, allowing the NT domain to be used in much the same manner that NIS+ is used within UNIX-only environments.

The end result is that whenever any program on the UNIX machine asks the operating system to lookup a user or group name, the query will be resolved by asking the NT Domain Controller for the specified domain to do the lookup. Because Winbind hooks into the operating system at a low level (via the NSS name resolution modules in the C library), this redirection to the NT Domain Controller is completely transparent.

Users on the UNIX machine can then use NT user and group names as they would “*native*” UNIX names. They can chown files so they are owned by NT domain users or even login to the UNIX machine and run a UNIX X-Window session as a domain user.

The only obvious indication that Winbind is being used is that user and group names take the form `DOMAIN\user` and `DOMAIN\group`. This is necessary as it allows Winbind to determine that redirection to a Domain Controller is wanted for a particular lookup and which trusted domain is being referenced.

Additionally, Winbind provides an authentication service that hooks into the Pluggable Authentication Modules (PAM) system to provide authentication via an NT domain to any PAM-enabled applications. This capability solves the problem of synchronizing passwords between systems since all passwords are stored in a single location (on the Domain Controller).

21.3.1 Target Uses

Winbind is targeted at organizations that have an existing NT-based domain infrastructure into which they wish to put UNIX workstations or servers. Winbind will allow these organizations to deploy UNIX workstations without having to maintain a separate account infrastructure. This greatly simplifies the administrative overhead of deploying UNIX workstations into an NT-based organization.

Another interesting way in which we expect Winbind to be used is as a central part of UNIX-based appliances. Appliances that provide file and print services to Microsoft-based networks will be able to use Winbind to provide seamless integration of the appliance into the domain.

21.4 How Winbind Works

The Winbind system is designed around a client/server architecture. A long running **winbindd** daemon listens on a UNIX domain socket waiting for requests to arrive. These requests are generated by the NSS and PAM clients and is processed sequentially.

The technologies used to implement Winbind are described in detail below.

21.4.1 Microsoft Remote Procedure Calls

Over the last few years, efforts have been underway by various Samba Team members to decode various aspects of the Microsoft Remote Procedure Call (MSRPC) system. This system is used for most network-related operations between Windows NT machines including remote management, user authentication and print spooling. Although initially this work was done to aid the implementation of Primary Domain Controller (PDC) functionality in Samba, it has also yielded a body of code that can be used for other purposes.

Winbind uses various MSRPC calls to enumerate domain users and groups and to obtain detailed information about individual users or groups. Other MSRPC calls can be used to authenticate NT domain users and to change user passwords. By directly querying a Windows PDC for user and group information, Winbind maps the NT account information onto UNIX user and group names.

21.4.2 Microsoft Active Directory Services

Since late 2001, Samba has gained the ability to interact with Microsoft Windows 2000 using its “*Native Mode*” protocols, rather than the NT4 RPC services. Using LDAP and Kerberos, a Domain Member running Winbind can enumerate users and groups in exactly the same way as a Windows 200x client would, and in so doing provide a much more efficient and effective Winbind implementation.

21.4.3 Name Service Switch

The Name Service Switch, or NSS, is a feature that is present in many UNIX operating systems. It allows system information such as hostnames, mail aliases and user information to be resolved from different sources. For example, a standalone UNIX workstation may resolve system information from a series of flat files stored on the local filesystem. A networked workstation may first attempt to resolve system information from local files, and then consult an NIS database for user information or a DNS server for hostname information.

The NSS application programming interface allows Winbind to present itself as a source of system information when resolving UNIX usernames and groups. Winbind uses this interface, and information obtained from a Windows NT server using MSRPC calls to provide a new source of account enumeration. Using standard UNIX library calls, one can enumerate the users and groups on a UNIX machine running Winbind and see all users and groups in a NT domain plus any trusted domain as though they were local users and groups.

The primary control file for NSS is `/etc/nsswitch.conf`. When a UNIX application makes a request to do a lookup, the C library looks in `/etc/nsswitch.conf` for a line that matches

the service type being requested, for example the “*passwd*” service type is used when user or group names are looked up. This config line specifies which implementations of that service should be tried and in what order. If the *passwd* config line is:

```
passwd: files example
```

then the C library will first load a module called `/lib/libnss_files.so` followed by the module `/lib/libnss_example.so`. The C library will dynamically load each of these modules in turn and call resolver functions within the modules to try to resolve the request. Once the request is resolved, the C library returns the result to the application.

This NSS interface provides an easy way for Winbind to hook into the operating system. All that needs to be done is to put `libnss_winbind.so` in `/lib/` then add “*winbind*” into `/etc/nsswitch.conf` at the appropriate place. The C library will then call Winbind to resolve user and group names.

21.4.4 Pluggable Authentication Modules

Pluggable Authentication Modules, also known as PAM, is a system for abstracting authentication and authorization technologies. With a PAM module it is possible to specify different authentication methods for different system applications without having to recompile these applications. PAM is also useful for implementing a particular policy for authorization. For example, a system administrator may only allow console logins from users stored in the local password file but only allow users resolved from a NIS database to log in over the network.

Winbind uses the authentication management and password management PAM interface to integrate Windows NT users into a UNIX system. This allows Windows NT users to log in to a UNIX machine and be authenticated against a suitable Primary Domain Controller. These users can also change their passwords and have this change take effect directly on the Primary Domain Controller.

PAM is configured by providing control files in the directory `/etc/pam.d/` for each of the services that require authentication. When an authentication request is made by an application, the PAM code in the C library looks up this control file to determine what modules to load to do the authentication check and in what order. This interface makes adding a new authentication service for Winbind very easy. All that needs to be done is that the `pam_winbind.so` module is copied to `/lib/security/` and the PAM control files for relevant services are updated to allow authentication via Winbind. See the PAM documentation in PAM-Based Distributed Authentication for more information.

21.4.5 User and Group ID Allocation

When a user or group is created under Windows NT/200x it is allocated a numerical relative identifier (RID). This is slightly different from UNIX which has a range of numbers that are used to identify users, and the same range in which to identify groups. It is Winbind’s job to convert RIDs to UNIX ID numbers and vice versa. When Winbind is configured, it is given part of the UNIX user ID space and a part of the UNIX group ID space in which to store Windows NT users and groups. If a Windows NT user is resolved for the first time, it

is allocated the next UNIX ID from the range. The same process applies for Windows NT groups. Over time, Winbind will have mapped all Windows NT users and groups to UNIX user IDs and group IDs.

The results of this mapping are stored persistently in an ID mapping database held in a tdb database). This ensures that RIDs are mapped to UNIX IDs in a consistent way.

21.4.6 Result Caching

An active system can generate a lot of user and group name lookups. To reduce the network cost of these lookups, Winbind uses a caching scheme based on the SAM sequence number supplied by NT Domain Controllers. User or group information returned by a PDC is cached by Winbind along with a sequence number also returned by the PDC. This sequence number is incremented by Windows NT whenever any user or group information is modified. If a cached entry has expired, the sequence number is requested from the PDC and compared against the sequence number of the cached entry. If the sequence numbers do not match, then the cached information is discarded and up-to-date information is requested directly from the PDC.

21.5 Installation and Configuration

21.5.1 Introduction

This section describes the procedures used to get Winbind up and running. Winbind is capable of providing access and authentication control for Windows Domain users through an NT or Windows 200x PDC for regular services, such as telnet and ftp, as well for Samba services.

- *Why should I do this?*

This allows the Samba administrator to rely on the authentication mechanisms on the Windows NT/200x PDC for the authentication of Domain Members. Windows NT/200x users no longer need to have separate accounts on the Samba server.

- *Who should be reading this document?*

This document is designed for system administrators. If you are implementing Samba on a file server and wish to (fairly easily) integrate existing Windows NT/200x users from your PDC onto the Samba server, this document is for you.

21.5.2 Requirements

If you have a Samba configuration file that you are currently using, **BACK IT UP!** If your system already uses PAM, **back up the `/etc/pam.d` directory contents!** If you haven't already made a boot disk, **MAKE ONE NOW!**

Messing with the PAM configuration files can make it nearly impossible to log in to your machine. That's why you want to be able to boot back into your machine in single user mode

and restore your `/etc/pam.d` back to the original state they were in if you get frustrated with the way things are going.

The latest version of Samba-3 includes a functioning winbindd daemon. Please refer to the main Samba Web page <<http://samba.org/>> or, better yet, your closest Samba mirror site for instructions on downloading the source code.

To allow domain users the ability to access Samba shares and files, as well as potentially other services provided by your Samba machine, PAM must be set up properly on your machine. In order to compile the Winbind modules, you should have at least the PAM development libraries installed on your system. Please refer the PAM web site <<http://www.kernel.org/pub/linux/libs/pam/>>.

21.5.3 Testing Things Out

Before starting, it is probably best to kill off all the Samba-related daemons running on your server. Kill off all `smbd`, `nmbd`, and `winbindd` processes that may be running. To use PAM, make sure that you have the standard PAM package that supplies the `/etc/pam.d` directory structure, including the PAM modules that are used by PAM-aware services, several `pam` libraries, and the `/usr/doc` and `/usr/man` entries for `pam`. Winbind built better in Samba if the `pam-devel` package is also installed. This package includes the header files needed to compile PAM-aware applications.

21.5.3.1 Configure `nsswitch.conf` and the Winbind Libraries on Linux and Solaris

PAM is a standard component of most current generation UNIX/Linux systems. Unfortunately, few systems install the `pam-devel` libraries that are needed to build PAM-enabled Samba. Additionally, Samba-3 may auto-install the Winbind files into their correct locations on your system, so before you get too far down the track be sure to check if the following configuration is really necessary. You may only need to configure `/etc/nsswitch.conf`.

The libraries needed to run the winbindd daemon through `nsswitch` need to be copied to their proper locations:

```
root# cp ../samba/source/nsswitch/libnss_winbind.so /lib
```

I also found it necessary to make the following symbolic link:

```
root# ln -s /lib/libnss_winbind.so /lib/libnss_winbind.so.2
```

And, in the case of Sun Solaris:

```
root# ln -s /usr/lib/libnss_winbind.so /usr/lib/libnss_winbind.so.1
root# ln -s /usr/lib/libnss_winbind.so /usr/lib/nss_winbind.so.1
root# ln -s /usr/lib/libnss_winbind.so /usr/lib/nss_winbind.so.2
```

Now, as root you need to edit `/etc/nsswitch.conf` to allow user and group entries to be visible from the winbindd daemon. My `/etc/nsswitch.conf` file look like this after editing:

```
passwd:    files winbind
shadow:   files
group:    files winbind
```

The libraries needed by the **winbindd** daemon will be automatically entered into the **ld-config** cache the next time your system reboots, but it is faster (and you do not need to reboot) if you do it manually:

```
root#/sbin/ldconfig -v | grep winbind
```

This makes `libnss_winbind` available to winbindd and echos back a check to you.

21.5.3.2 NSS Winbind on AIX

(This section is only for those running AIX.)

The Winbind AIX identification module gets built as `libnss_winbind.so` in the `nsswitch` directory of the Samba source. This file can be copied to `/usr/lib/security`, and the AIX naming convention would indicate that it should be named `WINBIND`. A stanza like the following:

```
WINBIND:
    program = /usr/lib/security/WINBIND
    options = authonly
```

can then be added to `/usr/lib/security/methods.cfg`. This module only supports identification, but there have been success reports using the standard Winbind PAM module for authentication. Use caution configuring loadable authentication modules since you can make it impossible to logon to the system. More information about the AIX authentication module API can be found at “*Kernel Extensions and Device Support Programming Concepts for AIX*” in Chapter 18 (John, there is no section like this in 18). Loadable Authentication Module Programming Interface <http://publibn.boulder.ibm.com/doc_link/en_US/a_doc_lib/aixprgkd/kernextc/sec_load_mod.htm> and more information on administering the modules can be found at “*System Management Guide: Operating System and Devices*.” <http://publibn.boulder.ibm.com/doc_link/en_US/a_doc_lib/aixbman/baseadm/iandaadmin.htm>

21.5.3.3 Configure `smb.conf`

Several parameters are needed in the `smb.conf` file to control the behavior of winbindd. These are described in more detail in the winbindd(8) man page. My `smb.conf` file, as shown in the next example, was modified to include the necessary entries in the [global] section.

Example 21.5.1. smb.conf for Winbind set-up

```
[global]
# separate domain and username with '\', like DOMAIN\username
    winbind separator = \
# use uids from 10000 to 20000 for domain users
    idmap uid = 10000-20000
# use gids from 10000 to 20000 for domain groups
    idmap gid = 10000-20000
# allow enumeration of winbind users and groups
    winbind enum users = yes
    winbind enum groups = yes
# give winbind users a real shell (only needed if they have telnet access)
    template homedir = /home/winnt/%D/%U
    template shell = /bin/bash
```

21.5.3.4 Join the Samba Server to the PDC Domain

Enter the following command to make the Samba server join the PDC domain, where *PDC* is the name of your PDC and *Administrator* is a domain user who has administrative privileges in the domain.

```
root#/usr/local/samba/bin/net rpc join -S PDC -U Administrator
```

The proper response to the command should be: “*Joined the domain DOMAIN*” where *DOMAIN* is your DOMAIN name.

21.5.3.5 Starting and Testing the winbindd Daemon

Eventually, you will want to modify your Samba startup script to automatically invoke the winbindd daemon when the other parts of Samba start, but it is possible to test out just the Winbind portion first. To start up Winbind services, enter the following command as root:

```
root#/usr/local/samba/sbin/winbindd
```

NOTE

The above assumes that Samba has been installed in the `/usr/local/samba` directory tree. You may need to search for the location of Samba files if this is not the location of **winbindd** on your system.

Winbindd can now also run in “*dual daemon mode*”. This will make it run as two processes. The first will answer all requests from the cache, thus making responses to clients faster. The

other will update the cache for the query that the first has just responded. The advantage of this is that responses stay accurate and are faster. You can enable dual daemon mode by adding `-B` to the command-line:

```
root#/usr/local/samba/sbin/winbindd -B
```

I'm always paranoid and like to make sure the daemon is really running.

```
root#ps -ae | grep winbindd
```

This command should produce output like this, if the daemon is running you would expect to see a report something like this:

```
3025 ?          00:00:00 winbindd
```

Now, for the real test, try to get some information about the users on your PDC:

```
root#/usr/local/samba/bin/wbinfo -u
```

This should echo back a list of users on your Windows users on your PDC. For example, I get the following response:

```
CEO\Administrator
CEO\burdell
CEO\Guest
CEO\jt-ad
CEO\krbtgt
CEO\TsInternetUser
```

Obviously, I have named my domain “*CEO*” and my winbind separator is “\”.

You can do the same sort of thing to get group information from the PDC:

```
root# /usr/local/samba/bin/wbinfo -g
CEO\Domain Admins
CEO\Domain Users
CEO\Domain Guests
CEO\Domain Computers
CEO\Domain Controllers
CEO\Cert Publishers
CEO\Schema Admins
CEO\Enterprise Admins
CEO\Group Policy Creator Owners
```

The function **getent** can now be used to get unified lists of both local and PDC users and groups. Try the following command:

```
root#getent passwd
```

You should get a list that looks like your `/etc/passwd` list followed by the domain users with their new UIDs, GIDs, home directories and default shells.

The same thing can be done for groups with the command:

```
root#getent group
```

21.5.3.6 Fix the `init.d` Startup Scripts

Linux The `winbindd` daemon needs to start up after the `smbd` and `nmbd` daemons are running. To accomplish this task, you need to modify the startup scripts of your system. They are located at `/etc/init.d/smb` in Red Hat Linux and they are located in `/etc/init.d/samba` in Debian Linux. Edit your script to add commands to invoke this daemon in the proper sequence. My startup script starts up `smbd`, `nmbd`, and `winbindd` from the `/usr/local/samba/bin` directory directly. The `start` function in the script looks like this:

```
start() {
    KIND="SMB"
    echo -n $"Starting $KIND services: "
    daemon /usr/local/samba/bin/smbd $SMBDOPTIONS
    RETVAL=$?
    echo
    KIND="NMB"
    echo -n $"Starting $KIND services: "
    daemon /usr/local/samba/bin/nmbd $NMBDOPTIONS
    RETVAL2=$?
    echo
    KIND="Winbind"
    echo -n $"Starting $KIND services: "
    daemon /usr/local/samba/sbin/winbindd
    RETVAL3=$?
    echo
    [ $RETVAL -eq 0 -a $RETVAL2 -eq 0 -a $RETVAL3 -eq 0 ] && \
    touch /var/lock/subsys/smb || RETVAL=1
    return $RETVAL
}
```

If you would like to run `winbindd` in dual daemon mode, replace the line :

```
daemon /usr/local/samba/sbin/winbindd
```

in the example above with:

```
daemon /usr/local/samba/sbin/winbindd -B
```

The **stop** function has a corresponding entry to shut down the services and looks like this:

```
stop() {
    KIND="SMB"
    echo -n $"Shutting down $KIND services: "
    killproc smbd
    RETVAL=$?
    echo
    KIND="NMB"
    echo -n $"Shutting down $KIND services: "
    killproc nmbd
    RETVAL2=$?
    echo
    KIND="Winbind"
    echo -n $"Shutting down $KIND services: "
    killproc winbindd
    RETVAL3=$?
    [ $RETVAL -eq 0 -a $RETVAL2 -eq 0 -a $RETVAL3 -eq 0 ] && \
    rm -f /var/lock/subsys/smb
    echo ""
    return $RETVAL
}
```

Solaris Winbind does not work on Solaris 9, see Winbind on Solaris 9 section for details.

On Solaris, you need to modify the `/etc/init.d/samba.server` startup script. It usually only starts `smbd` and `nmbd` but should now start `winbindd`, too. If you have Samba installed in `/usr/local/samba/bin`, the file could contains something like this:

```
##
## samba.server
##

if [ ! -d /usr/bin ]
then
    # /usr not mounted
    exit
fi

killproc() {
    # kill the named process(es)
    pid='/usr/bin/ps -e |
        /usr/bin/grep -w $1 |
        /usr/bin/sed -e 's/^ *//' -e 's/ .*//''
    [ "$pid" != "" ] && kill $pid
}
```



```
# Start/stop processes required for Samba server

case "$1" in

'start')
#
# Edit these lines to suit your installation (paths, workgroup, host)
#
echo Starting SMBD
    /usr/local/samba/bin/smbd -D -s \
    /usr/local/samba/smb.conf

echo Starting NMBD
    /usr/local/samba/bin/nmbd -D -l \
    /usr/local/samba/var/log -s /usr/local/samba/smb.conf

echo Starting Winbind Daemon
    /usr/local/samba/sbin/winbindd
    ;;

'stop')
    killproc nmbd
    killproc smbd
    killproc winbindd
    ;;

*)
    echo "Usage: /etc/init.d/samba.server { start | stop }"
    ;;
esac
```

Again, if you would like to run Samba in dual daemon mode, replace:

```
/usr/local/samba/sbin/winbindd
```

in the script above with:

```
/usr/local/samba/sbin/winbindd -B
```

Restarting If you restart the smbd, nmbd, and winbindd daemons at this point, you should be able to connect to the Samba server as a Domain Member just as if you were a local user.

21.5.3.7 Configure Winbind and PAM

If you have made it this far, you know that **winbindd** and Samba are working together. If you want to use Winbind to provide authentication for other services, keep reading. The PAM configuration files need to be altered in this step. (Did you remember to make backups of your original `/etc/pam.d` files? If not, do it now.)

You will need a PAM module to use winbindd with these other services. This module will be compiled in the `./source/nsswitch` directory by invoking the command:

```
root#make nsswitch/pam_winbind.so
```

from the `./source` directory. The `pam_winbind.so` file should be copied to the location of your other PAM security modules. On my Red Hat system, this was the `/lib/security` directory. On Solaris, the PAM security modules reside in `/usr/lib/security`.

```
root#cp ../samba/source/nsswitch/pam_winbind.so /lib/security
```

Linux/FreeBSD-specific PAM configuration The `/etc/pam.d/samba` file does not need to be changed. I just left this file as it was:

```
auth    required      /lib/security/pam_stack.so service=system-auth
account required      /lib/security/pam_stack.so service=system-auth
```

The other services that I modified to allow the use of Winbind as an authentication service were the normal login on the console (or a terminal session), telnet logins, and ftp service. In order to enable these services, you may first need to change the entries in `/etc/xinetd.d` (or `/etc/inetd.conf`). Red Hat Linux 7.1 and later uses the new xinetd.d structure, in this case you need to change the lines in `/etc/xinetd.d/telnet` and `/etc/xinetd.d/wu-ftp` from

```
enable = no
```

to:

```
enable = yes
```

For ftp services to work properly, you will also need to either have individual directories for the domain users already present on the server, or change the home directory template to a general directory for all domain users. These can be easily set using the `smb.conf` global entry template `homedir`.

NOTE



The directory in template homedir is not created automatically! Use `pam_mkhomedir` or pre-create the directories of users to make sure users can log in on UNIX with their own home directory.

The `/etc/pam.d/ftp` file can be changed to allow Winbind ftp access in a manner similar to the samba file. My `/etc/pam.d/ftp` file was changed to look like this:

```
auth      required      /lib/security/pam_listfile.so item=user sense=deny \
          file=/etc/ftpusers onerr=succeed
auth      sufficient    /lib/security/pam_winbind.so
auth      required      /lib/security/pam_stack.so service=system-auth
auth      required      /lib/security/pam_shells.so
account   sufficient    /lib/security/pam_winbind.so
account   required      /lib/security/pam_stack.so service=system-auth
session   required      /lib/security/pam_stack.so service=system-auth
```

The `/etc/pam.d/login` file can be changed nearly the same way. It now looks like this:

```
auth      required      /lib/security/pam_securetty.so
auth      sufficient    /lib/security/pam_winbind.so
auth      sufficient    /lib/security/pam_unix.so use_first_pass
auth      required      /lib/security/pam_stack.so service=system-auth
auth      required      /lib/security/pam_nologin.so
account   sufficient    /lib/security/pam_winbind.so
account   required      /lib/security/pam_stack.so service=system-auth
password  required      /lib/security/pam_stack.so service=system-auth
session   required      /lib/security/pam_stack.so service=system-auth
session   optional      /lib/security/pam_console.so
```

In this case, I added the

```
auth sufficient /lib/security/pam_winbind.so
```

lines as before, but also added the

```
required pam_securetty.so
```

above it, to disallow root logins over the network. I also added a

```
sufficient /lib/security/pam_unix.so use_first_pass
```

line after the `winbind.so` line to get rid of annoying double prompts for passwords.

Solaris-specific configuration The `/etc/pam.conf` needs to be changed. I changed this file so my Domain users can logon both locally as well as telnet. The following are the

changes that I made. You can customize the `pam.conf` file as per your requirements, but be sure of those changes because in the worst case it will leave your system nearly impossible to boot.

```
#
#ident "@(#)pam.conf 1.14 99/09/16 SMI"
#
# Copyright (c) 1996-1999, Sun Microsystems, Inc.
# All Rights Reserved.
#
# PAM configuration
#
# Authentication management
#
login  auth required  /usr/lib/security/pam_winbind.so
login  auth required  /usr/lib/security/$ISA/pam_unix.so.1 try_first_pass
login  auth required  /usr/lib/security/$ISA/pam_dial_auth.so.1 try_first_pass
#
rlogin auth sufficient /usr/lib/security/pam_winbind.so
rlogin auth sufficient /usr/lib/security/$ISA/pam_rhosts_auth.so.1
rlogin auth required  /usr/lib/security/$ISA/pam_unix.so.1 try_first_pass
#
dtlogin auth sufficient /usr/lib/security/pam_winbind.so
dtlogin auth required  /usr/lib/security/$ISA/pam_unix.so.1 try_first_pass
#
rsh auth required /usr/lib/security/$ISA/pam_rhosts_auth.so.1
other  auth sufficient /usr/lib/security/pam_winbind.so
other  auth required  /usr/lib/security/$ISA/pam_unix.so.1 try_first_pass
#
# Account management
#
login  account sufficient      /usr/lib/security/pam_winbind.so
login  account requisite /usr/lib/security/$ISA/pam_roles.so.1
login  account required /usr/lib/security/$ISA/pam_unix.so.1
#
dtlogin account sufficient      /usr/lib/security/pam_winbind.so
dtlogin account requisite /usr/lib/security/$ISA/pam_roles.so.1
dtlogin account required /usr/lib/security/$ISA/pam_unix.so.1
#
other  account sufficient      /usr/lib/security/pam_winbind.so
other  account requisite /usr/lib/security/$ISA/pam_roles.so.1
other  account required /usr/lib/security/$ISA/pam_unix.so.1
#
# Session management
#
other session required /usr/lib/security/$ISA/pam_unix.so.1
#
```

```
# Password management
#
#other password sufficient /usr/lib/security/pam_winbind.so
other password required /usr/lib/security/$ISA/pam_unix.so.1
dtssession auth required /usr/lib/security/$ISA/pam_unix.so.1
#
# Support for Kerberos V5 authentication (uncomment to use Kerberos)
#
#rlogin auth optional /usr/lib/security/$ISA/pam_krb5.so.1 try_first_pass
#login auth optional /usr/lib/security/$ISA/pam_krb5.so.1 try_first_pass
#dtlogin auth optional /usr/lib/security/$ISA/pam_krb5.so.1 try_first_pass
#other auth optional /usr/lib/security/$ISA/pam_krb5.so.1 try_first_pass
#dtlogin account optional /usr/lib/security/$ISA/pam_krb5.so.1
#other account optional /usr/lib/security/$ISA/pam_krb5.so.1
#other session optional /usr/lib/security/$ISA/pam_krb5.so.1
#other password optional /usr/lib/security/$ISA/pam_krb5.so.1 try_first_pass
```

I also added a *try_first_pass* line after the *winbind.so* line to get rid of annoying double prompts for passwords.

Now restart your Samba and try connecting through your application that you configured in the *pam.conf*.

21.6 Conclusion

The Winbind system, through the use of the Name Service Switch, Pluggable Authentication Modules, and appropriate Microsoft RPC calls have allowed us to provide seamless integration of Microsoft Windows NT domain users on a UNIX system. The result is a great reduction in the administrative cost of running a mixed UNIX and NT network.

21.7 Common Errors

Winbind has a number of limitations in its current released version that we hope to overcome in future releases:

- Winbind is currently only available for the Linux, Solaris, AIX, and IRIX operating systems, although ports to other operating systems are certainly possible. For such ports to be feasible, we require the C library of the target operating system to support the Name Service Switch and Pluggable Authentication Modules systems. This is becoming more common as NSS and PAM gain support among UNIX vendors.
- The mappings of Windows NT RIDs to UNIX IDs is not made algorithmically and depends on the order in which unmapped users or groups are seen by Winbind. It may be difficult to recover the mappings of RID to UNIX ID mapping if the file containing this information is corrupted or destroyed.

- Currently the Winbind PAM module does not take into account possible workstation and logon time restrictions that may be set for Windows NT users, this is instead up to the PDC to enforce.

21.7.1 NSCD Problem Warning

WARNING

Do not under any circumstances run **nscd** on any system on which **winbindd** is running.

If **nscd** is running on the UNIX/Linux system, then even though NSSWITCH is correctly configured it will not be possible to resolve domain users and groups for file and directory controls.

21.7.2 Winbind Is Not Resolving Users and Groups

“My smb.conf file is correctly configured. I have specified idmap uid = 12000, and idmap gid = 3000-3500 and winbind is running. When I do the following it all works fine.”

```
root# wbinfo -u
MIDEARTH\maryo
MIDEARTH\jackb
MIDEARTH\ameds
...
MIDEARTH\root
```

```
root# wbinfo -g
MIDEARTH\Domain Users
MIDEARTH\Domain Admins
MIDEARTH\Domain Guests
...
MIDEARTH\Accounts
```

```
root# getent passwd
root:x:0:0:root:/root:/bin/bash
bin:x:1:1:bin:/bin:/bin/bash
...
maryo:x:15000:15003:Mary Orville:/home/MIDEARTH/maryo:/bin/false
```

“But the following command just fails:

```
root# chown maryo a_file
chown: 'maryo': invalid user
```

This is driving me nuts! What can be wrong?

Same problem as the one above. Your system is likely running **nscd**, the name service caching daemon. Shut it down, do not restart it! You will find your problem resolved.

ADVANCED NETWORK MANAGEMENT

This section documents peripheral issues that are of great importance to network administrators who want to improve network resource access control, to automate the user environment and to make their lives a little easier.

22.1 Features and Benefits

Often the difference between a working network environment and a well appreciated one can best be measured by the *little things* that make everything work more harmoniously. A key part of every network environment solution is the ability to remotely manage MS Windows workstations, remotely access the Samba server, provide customized logon scripts, as well as other housekeeping activities that help to sustain more reliable network operations.

This chapter presents information on each of these areas. They are placed here, and not in other chapters, for ease of reference.

22.2 Remote Server Administration

“How do I get ‘User Manager’ and ‘Server Manager’?”

Since I do not need to buy an NT4 Server, how do I get the ‘User Manager for Domains’ and the ‘Server Manager’?

Microsoft distributes a version of these tools called `Nexus.exe` for installation on Windows 9x/Me systems. The tools set includes:

- Server Manager
- User Manager for Domains
- Event Viewer

Download the archived file at <ftp://ftp.microsoft.com/Softlib/MSLFILES/NEXUS.EXE>.
<<ftp://ftp.microsoft.com/Softlib/MSLFILES/NEXUS.EXE>>

The Windows NT 4.0 version of the ‘User Manager for Domains’ and ‘Server Manager’ are available from Microsoft via ftp <<ftp://ftp.microsoft.com/Softlib/MSLFILES/SRVTOOLS.EXE>>.

22.3 Remote Desktop Management

There are a number of possible remote desktop management solutions that range from free through costly. Do not let that put you off. Sometimes the most costly solution is the most cost effective. In any case, you will need to draw your own conclusions as to which is the best tool in your network environment.

22.3.1 Remote Management from NoMachine.Com

The following information was posted to the Samba mailing list at Apr 3 23:33:50 GMT 2003. It is presented in slightly edited form (with author details omitted for privacy reasons). The entire answer is reproduced below with some comments removed.

“I have a wonderful Linux/Samba server running as pdc for a network. Now I would like to add remote desktop capabilities so users outside could login to the system and get their desktop up from home or another country.”

“Is there a way to accomplish this? Do I need a Windows Terminal Server? Do I need to configure it so it is a member of the domain or a BDC,PDC? Are there any hacks for MS Windows XP to enable remote login even if the computer is in a domain?”

Answer provided: Check out the new offer of “NX” software from NoMachine <<http://www.nomachine.com/>>.

It implements an easy-to-use interface to the Remote X protocol as well as incorporating VNC/RFB and rdesktop/RDP into it, but at a speed performance much better than anything you may have ever seen.

Remote X is not new at all, but what they did achieve successfully is a new way of compression and caching technologies that makes the thing fast enough to run even over slow modem/ISDN connections.

I could test drive their (public) Red Hat machine in Italy, over a loaded Internet connection, with enabled thumbnail previews in KDE konqueror which popped up immediately on “mouse-over”. From inside that (remote X) session I started a rdesktop session on another, a Windows XP machine. To test the performance, I played Pinball. I am proud to announce that my score was 631750 points at first try.

NX performs better on my local LAN than any of the other “pure” connection methods I am using from time to time: TightVNC, rdesktop or Remote X. It is even faster than a direct crosslink connection between two nodes.

I even got sound playing from the Remote X app to my local boxes, and had a working “copy’n’paste” from an NX window (running a KDE session in Italy) to my Mozilla mailing agent. These guys are certainly doing something right!

I recommend to test drive NX to anybody with a only a passing interest in remote computing <<http://www.nomachine.com/testdrive.php>>.

Just download the free of charge client software (available for Red Hat, SuSE, Debian and Windows) and be up and running within five minutes (they need to send you your account data, though, because you are assigned a real UNIX account on their testdrive.nomachine.com box.

They plan to get to the point were you can have NX application servers running as a cluster of nodes, and users simply start an NX session locally, and can select applications to run transparently (apps may even run on another NX node, but pretend to be on the same as used for initial login, because it displays in the same window. You also can run it full-screen, and after a short time you forget that it is a remote session at all).

Now the best thing for last: All the core compression and caching technologies are released under the GPL and available as source code to anybody who wants to build on it! These technologies are working, albeit started from the command line only (and very inconvenient to use in order to get a fully running remote X session up and running.)

To answer your questions:

- You do not need to install a terminal server; XP has RDP support built in.
- NX is much cheaper than Citrix — and comparable in performance, probably faster.
- You do not need to hack XP — it just works.
- You log into the XP box from remote transparently (and I think there is no need to change anything to get a connection, even if authentication is against a domain).
- The NX core technologies are all Open Source and released under the GPL — you can now use a (very inconvenient) command-line at no cost, but you can buy a comfortable (proprietary) NX GUI front end for money.
- NoMachine are encouraging and offering help to OSS/Free Software implementations for such a front end too, even if it means competition to them (they have written to this effect even to the LTSP, KDE and GNOME developer mailing lists).

22.4 Network Logon Script Magic

There are several opportunities for creating a custom network startup configuration environment.

- No Logon Script.
- Simple universal Logon Script that applies to all users.
- Use of a conditional Logon Script that applies per user or per group attributes.
- Use of Samba's preexec and postexec functions on access to the NETLOGON share to create a custom logon script and then execute it.
- User of a tool such as KixStart.

The Samba source code tree includes two logon script generation/execution tools. See `examples` directory `genlogon` and `ntlogon` subdirectories.

The following listings are from the `genlogon` directory.

This is the `genlogon.pl` file:

```
#!/usr/bin/perl
#
# genlogon.pl
#
# Perl script to generate user logon scripts on the fly, when users
# connect from a Windows client. This script should be called from
# smb.conf with the %U, %G and %L parameters. I.e:
#
#     root preexec = genlogon.pl %U %G %L
#
# The script generated will perform
# the following:
#
# 1. Log the user connection to /var/log/samba/netlogon.log
# 2. Set the PC's time to the Linux server time (which is maintained
#    daily to the National Institute of Standards Atomic clock on the
#    internet.
# 3. Connect the user's home drive to H: (H for Home).
# 4. Connect common drives that everyone uses.
# 5. Connect group-specific drives for certain user groups.
# 6. Connect user-specific drives for certain users.
# 7. Connect network printers.

# Log client connection
#($sec,$min,$hour,$mday,$mon,$year,$wday,$yday,$isdst) = localtime(time);
#($sec,$min,$hour,$mday,$mon,$year,$wday,$yday,$isdst) = localtime(time);
open LOG, ">>/var/log/samba/netlogon.log";
print LOG "$mon/$mday/$year $hour:$min:$sec";
print LOG " - User $ARGV[0] logged into $ARGV[1]\n";
close LOG;

# Start generating logon script
open LOGON, ">/shared/netlogon/$ARGV[0].bat";
print LOGON "@ECHO OFF\r\n";

# Connect shares just use by Software Development group
if ($ARGV[1] eq "SOFTDEV" || $ARGV[0] eq "softdev")
{
    print LOGON "NET USE M: \\$ARGV[2]\\SOURCE\r\n";
}
}
```

```

# Connect shares just use by Technical Support staff
if ($ARGV[1] eq "SUPPORT" || $ARGV[0] eq "support")
{
    print LOGON "NET USE S: \\\$ARGV[2]\\SUPPORT\r\n";
}

# Connect shares just used by Administration staff
If ($ARGV[1] eq "ADMIN" || $ARGV[0] eq "admin")
{
    print LOGON "NET USE L: \\\$ARGV[2]\\ADMIN\r\n";
    print LOGON "NET USE K: \\\$ARGV[2]\\MKTING\r\n";
}

# Now connect Printers. We handle just two or three users a little
# differently, because they are the exceptions that have desktop
# printers on LPT1: - all other user's go to the LaserJet on the
# server.
if ($ARGV[0] eq 'jim'
    || $ARGV[0] eq 'yvonne')
{
    print LOGON "NET USE LPT2: \\\$ARGV[2]\\LJET3\r\n";
    print LOGON "NET USE LPT3: \\\$ARGV[2]\\FAXQ\r\n";
}
else
{
    print LOGON "NET USE LPT1: \\\$ARGV[2]\\LJET3\r\n";
    print LOGON "NET USE LPT3: \\\$ARGV[2]\\FAXQ\r\n";
}

# All done! Close the output file.
close LOGON;

```

Those wishing to use more elaborate or capable logon processing system should check out these sites:

- <<http://www.craigelachie.org/rhacer/ntlogon>>
- <<http://www.kixtart.org>>

22.4.1 Adding Printers without User Intervention

Printers may be added automatically during logon script processing through the use of:

```
C:\> rundll32 printui.dll,PrintUIEntry /?
```

See the documentation in the Microsoft knowledgebase article 189105. <<http://support.microsoft.com/default.asp?scid=kb;en-us;189105>>

SYSTEM AND ACCOUNT POLICIES

This chapter summarizes the current state of knowledge derived from personal practice and knowledge from Samba mailing list subscribers. Before reproduction of posted information, every effort has been made to validate the information given. Where additional information was uncovered through this validation it is provided also.

23.1 Features and Benefits

When MS Windows NT 3.5 was introduced, the hot new topic was the ability to implement Group Policies for users and groups. Then along came MS Windows NT4 and a few sites started to adopt this capability. How do we know that? By the number of “*boo-boos*” (or mistakes) administrators made and then requested help to resolve.

By the time that MS Windows 2000 and Active Directory was released, administrators got the message: Group Policies are a good thing! They can help reduce administrative costs and actually make happier users. But adoption of the true potential of MS Windows 200x Active Directory and Group Policy Objects (GPOs) for users and machines were picked up on rather slowly. This was obvious from the Samba mailing list as in 2000 and 2001 when there were few postings regarding GPOs and how to replicate them in a Samba environment.

Judging by the traffic volume since mid 2002, GPOs have become a standard part of the deployment in many sites. This chapter reviews techniques and methods that can be used to exploit opportunities for automation of control over user desktops and network client workstations.

A tool new to Samba — the **editreg** tool — may become an important part of the future Samba administrators’ arsenal is described in this document.

23.2 Creating and Managing System Policies

Under MS Windows platforms, particularly those following the release of MS Windows NT4 and MS Windows 95, it is possible to create a type of file that would be placed in the NETLOGON share of a Domain Controller. As the client logs onto the network, this file

is read and the contents initiate changes to the registry of the client machine. This file allows changes to be made to those parts of the registry that affect users, groups of users, or machines.

For MS Windows 9x/ME, this file must be called `Config.POL` and may be generated using a tool called `poledit.exe`, better known as the Policy Editor. The policy editor was provided on the Windows 98 installation CD, but disappeared again with the introduction of MS Windows Me (Millennium Edition). From comments of MS Windows network administrators, it would appear that this tool became a part of the MS Windows Me Resource Kit.

MS Windows NT4 Server products include the *System Policy Editor* under **Start -> Programs -> Administrative Tools**. For MS Windows NT4 and later clients, this file must be called `NTConfig.POL`.

New with the introduction of MS Windows 2000 was the Microsoft Management Console or MMC. This tool is the new wave in the ever-changing landscape of Microsoft methods for management of network access and security. Every new Microsoft product or technology seems to make the old rules obsolete and introduces newer and more complex tools and methods. To Microsoft's credit, the MMC does appear to be a step forward, but improved functionality comes at a great price.

Before embarking on the configuration of network and system policies, it is highly advisable to read the documentation available from Microsoft's Web site regarding Implementing Profiles and Policies in Windows NT 4.0 <http://www.microsoft.com/ntserver/management/deployment/planguide/prof_policies.asp> available from Microsoft. There are a large number of documents in addition to this old one that should also be read and understood. Try searching on the Microsoft Web site for "*Group Policies*".

What follows is a brief discussion with some helpful notes. The information provided here is incomplete — you are warned.

23.2.1 Windows 9x/ME Policies

You need the Windows 98 Group Policy Editor to set up Group Profiles under Windows 9x/ME. It can be found on the original full product Windows 98 installation CD under `tools/reskit/netadmin/poledit`. Install this using the Add/Remove Programs facility and then click on **Have Disk**.

Use the Group Policy Editor to create a policy file that specifies the location of user profiles and/or `My Documents`, and so on. Then save these settings in a file called `Config.POL` that needs to be placed in the root of the `[NETLOGON]` share. If Windows 98 is configured to log onto the Samba Domain, it will automatically read this file and update the Windows 9x/Me registry of the machine as it logs on.

Further details are covered in the Windows 98 Resource Kit documentation.

If you do not take the correct steps, then every so often Windows 9x/ME will check the integrity of the registry and restore its settings from the back-up copy of the registry it stores on each Windows 9x/ME machine. So, you will occasionally notice things changing back to the original settings.

Install the group policy handler for Windows 9x/Me to pick up Group Policies. Look on the Windows 98 CDROM in `\tools\reskit\netadmin\poledit`. Install group policies on a Windows 9x/Me client by double-clicking on `groupopol.inf`. Log off and on again a couple of times and see if Windows 98 picks up Group Policies. Unfortunately, this needs to be done on every Windows 9x/Me machine that uses Group Policies.

23.2.2 Windows NT4-Style Policy Files

To create or edit `ntconfig.pol` you must use the NT Server Policy Editor, `poledit.exe`, which is included with NT4 Server but not with NT Workstation. There is a Policy Editor on an NT4 Workstation but it is not suitable for creating domain policies. Furthermore, although the Windows 95 Policy Editor can be installed on an NT4 Workstation/Server, it will not work with NT clients. However, the files from the NT Server will run happily enough on an NT4 Workstation.

You need `poledit.exe`, `common.adm` and `winnt.adm`. It is convenient to put the two `*.adm` files in the `c:\winnt\inf` directory, which is where the binary will look for them unless told otherwise. This directory is normally “*hidden*.”

The Windows NT policy editor is also included with the Service Pack 3 (and later) for Windows NT 4.0. Extract the files using `servicpackname /x`, that's `Nt4sp6ai.exe /x` for service pack 6a. The Policy Editor, `poledit.exe`, and the associated template files (`*.adm`) should be extracted as well. It is also possible to download the policy template files for Office97 and get a copy of the Policy Editor. Another possible location is with the Zero Administration Kit available for download from Microsoft.

23.2.2.1 Registry Spoiling

With NT4-style registry-based policy changes, a large number of settings are not automatically reversed as the user logs off. The settings that were in the `NTConfig.POL` file were applied to the client machine registry and apply to the hive key `HKEY_LOCAL_MACHINE` are permanent until explicitly reversed. This is known as tattooing. It can have serious consequences downstream and the administrator must be extremely careful not to lock out the ability to manage the machine at a later date.

23.2.3 MS Windows 200x/XP Professional Policies

Windows NT4 system policies allow the setting of registry parameters specific to users, groups and computers (client workstations) that are members of the NT4-style domain. Such policy files will work with MS Windows 200x/XP clients also.

New to MS Windows 2000, Microsoft recently introduced a style of group policy that confers a superset of capabilities compared with NT4-style policies. Obviously, the tool used to create them is different, and the mechanism for implementing them is much improved.

The older NT4-style registry-based policies are known as *Administrative Templates* in MS Windows 2000/XP Group Policy Objects (GPOs). The later includes the ability to set various security configurations, enforce Internet Explorer browser settings, change and redirect aspects of the users desktop (including the location of `My Documents` files (directory),

as well as intrinsics of where menu items will appear in the Start menu). An additional new feature is the ability to make available particular software Windows applications to particular users and/or groups.

Remember, NT4 policy files are named `NTConfig.POL` and are stored in the root of the `NETLOGON` share on the Domain Controllers. A Windows NT4 user enters a username, password and selects the domain name to which the logon will attempt to take place. During the logon process, the client machine reads the `NTConfig.POL` file from the `NETLOGON` share on the authenticating server and modifies the local registry values according to the settings in this file.

Windows 200x GPOs are feature-rich. They are not stored in the `NETLOGON` share, but rather part of a Windows 200x policy file is stored in the Active Directory itself and the other part is stored in a shared (and replicated) volume called the `SYSVOL` folder. This folder is present on all Active Directory Domain Controllers. The part that is stored in the Active Directory itself is called the Group Policy Container (GPC), and the part that is stored in the replicated share called `SYSVOL` is known as the Group Policy Template (GPT).

With NT4 clients, the policy file is read and executed only as each user logs onto the network. MS Windows 200x policies are much more complex — GPOs are processed and applied at client machine startup (machine specific part) and when the user logs onto the network, the user-specific part is applied. In MS Windows 200x-style policy management, each machine and/or user may be subject to any number of concurrently applicable (and applied) policy sets (GPOs). Active Directory allows the administrator to also set filters over the policy settings. No such equivalent capability exists with NT4-style policy files.

23.2.3.1 Administration of Windows 200x/XP Policies

Instead of using the tool called The System Policy Editor, commonly called `Poedit` (from the executable name `poedit.exe`), GPOs are created and managed using a Microsoft Management Console (MMC) snap-in as follows:

1. Go to the Windows 200x/XP menu **Start->Programs->Administrative Tools** and select the MMC snap-in called **Active Directory Users and Computers**
2. Select the domain or organizational unit (OU) that you wish to manage, then right-click to open the context menu for that object, and select the **Properties**.
3. Left-click on the **Group Policy** tab, then left-click on the **New** tab. Type a name for the new policy you will create.
4. Left-click on the **Edit** tab to commence the steps needed to create the GPO.

All policy configuration options are controlled through the use of policy administrative templates. These files have an `.adm` extension, both in NT4 as well as in Windows 200x/XP. Beware, however, the `.adm` files are not interchangeable across NT4 and Windows 200x. The latter introduces many new features as well as extended definition capabilities. It is well beyond the scope of this documentation to explain how to program `.adm` files; for that the administrator is referred to the Microsoft Windows Resource Kit for your particular version of MS Windows.

NOTE



The MS Windows 2000 Resource Kit contains a tool called `gpolmig.exe`. This tool can be used to migrate an NT4 `NTConfig.POL` file into a Windows 200x style GPO. Be VERY careful how you use this powerful tool. Please refer to the resource kit manuals for specific usage information.

23.3 Managing Account/User Policies

Policies can define a specific user's settings or the settings for a group of users. The resulting policy file contains the registry settings for all users, groups, and computers that will be using the policy file. Separate policy files for each user, group, or computer are not necessary.

If you create a policy that will be automatically downloaded from validating Domain Controllers, you should name the file `NTConfig.POL`. As system administrator, you have the option of renaming the policy file and, by modifying the Windows NT-based workstation, directing the computer to update the policy from a manual path. You can do this by either manually changing the registry or by using the System Policy Editor. This can even be a local path such that each machine has its own policy file, but if a change is necessary to all machines, it must be made individually to each workstation.

When a Windows NT4/200x/XP machine logs onto the network, the client looks in the `NETLOGON` share on the authenticating domain controller for the presence of the `NTConfig.POL` file. If one exists it is downloaded, parsed and then applied to the user's part of the registry.

MS Windows 200x/XP clients that log onto an MS Windows Active Directory security domain may additionally acquire policy settings through Group Policy Objects (GPOs) that are defined and stored in Active Directory itself. The key benefit of using AS GPOs is that they impose no registry *spoiling* effect. This has considerable advantage compared with the use of `NTConfig.POL` (NT4) style policy updates.

In addition to user access controls that may be imposed or applied via system and/or group policies in a manner that works in conjunction with user profiles, the user management environment under MS Windows NT4/200x/XP allows per domain as well as per user account restrictions to be applied. Common restrictions that are frequently used include:

- Logon hours
- Password aging
- Permitted logon from certain machines only
- Account type (local or global)
- User rights

Samba-3.0.0 does not yet implement all account controls that are common to MS Windows NT4/200x/XP. While it is possible to set many controls using the Domain User Manager for MS Windows NT4, only password expiry is functional today. Most of the remaining controls at this time have only stub routines that may eventually be completed to provide actual control. Do not be misled by the fact that a parameter can be set using the NT4 Domain User Manager or in the `NTConfig.POL`.

23.4 Management Tools

Anyone who wishes to create or manage Group Policies will need to be familiar with a number of tools. The following sections describe a few key tools that will help you to create a low maintenance user environment.

23.4.1 Samba Editreg Tool-set

A new tool called **editreg** is under development. This tool can be used to edit registry files (called `NTUser.DAT`) that are stored in user and group profiles. `NTConfig.POL` files have the same structure as the `NTUser.DAT` file and can be edited using this tool. **editreg** is being built with the intent to enable `NTConfig.POL` files to be saved in text format and to permit the building of new `NTConfig.POL` files with extended capabilities. It is proving difficult to realize this capability, so do not be surprised if this feature does not materialize. Formal capabilities will be announced at the time that this tool is released for production use.

23.4.2 Windows NT4/200x

The tools that may be used to configure these types of controls from the MS Windows environment are: the NT4 User Manager for Domains, the NT4 System and Group Policy Editor, and the Registry Editor (`regedt32.exe`). Under MS Windows 200x/XP, this is done using the Microsoft Management Console (MMC) with appropriate “*snap-ins*,” the registry editor, and potentially also the NT4 System and Group Policy Editor.

23.4.3 Samba PDC

With a Samba Domain Controller, the new tools for managing user account and policy information include: **smpasswd**, **pdbedit**, **net**, **rpcclient**. The administrator should read the man pages for these tools and become familiar with their use.

23.5 System Startup and Logon Processing Overview

The following attempts to document the order of processing the system and user policies following a system reboot and as part of the user logon:

1. Network starts, then Remote Procedure Call System Service (RPCSS) and Multiple Universal Naming Convention Provider (MUP) start.

2. Where Active Directory is involved, an ordered list of Group Policy Objects (GPOs) is downloaded and applied. The list may include GPOs that:
 - Apply to the location of machines in a Directory.
 - Apply only when settings have changed.
 - Depend on configuration of the scope of applicability: local, site, domain, organizational unit, and so on.No desktop user interface is presented until the above have been processed.
3. Execution of start-up scripts (hidden and synchronous by default).
4. A keyboard action to effect start of logon (Ctrl-Alt-Del).
5. User credentials are validated, user profile is loaded (depends on policy settings).
6. An ordered list of user GPOs is obtained. The list contents depends on what is configured in respect of:
 - Is the user a Domain Member, thus subject to particular policies?
 - Loopback enablement, and the state of the loopback policy (Merge or Replace).
 - Location of the Active Directory itself.
 - Has the list of GPOs changed? No processing is needed if not changed.
7. User Policies are applied from Active Directory. Note: There are several types.
8. Logon scripts are run. New to Windows 200x and Active Directory, logon scripts may be obtained based on Group Policy objects (hidden and executed synchronously). NT4-style logon scripts are then run in a normal window.
9. The User Interface as determined from the GPOs is presented. Note: In a Samba domain (like an NT4 Domain), machine (system) policies are applied at start-up; user policies are applied at logon.

23.6 Common Errors

Policy-related problems can be quite difficult to diagnose and even more difficult to rectify. The following collection demonstrates only basic issues.

23.6.1 Policy Does Not Work

“We have created the `Config.POL` file and put it in the NETLOGON share. It has made no difference to our Win XP Pro machines, they just do not see it. It worked fine with Win 98 but does not work any longer since we upgraded to Win XP Pro. Any hints?”

Policy files are not portable between Windows 9x/Me and MS Windows NT4/200x/XP-based platforms. You need to use the NT4 Group Policy Editor to create a file called `NTConfig.POL` so it is in the correct format for your MS Windows XP Pro clients.

DESKTOP PROFILE MANAGEMENT

24.1 Features and Benefits

Roaming profiles are feared by some, hated by a few, loved by many, and a Godsend for some administrators.

Roaming profiles allow an administrator to make available a consistent user desktop as the user moves from one machine to another. This chapter provides much information regarding how to configure and manage roaming profiles.

While roaming profiles might sound like nirvana to some, they are a real and tangible problem to others. In particular, users of mobile computing tools, where often there may not be a sustained network connection, are often better served by purely local profiles. This chapter provides information to help the Samba administrator deal with those situations.

24.2 Roaming Profiles

WARNING

Roaming profiles support is different for Windows 9x/Me and Windows NT4/200x.

Before discussing how to configure roaming profiles, it is useful to see how Windows 9x/Me and Windows NT4/200x clients implement these features.

Windows 9x/Me clients send a NetUserGetInfo request to the server to get the user's profiles location. However, the response does not have room for a separate profiles location field, only the user's home share. This means that Windows 9x/Me profiles are restricted to being stored in the user's home directory.

Windows NT4/200x clients send a NetSAMLogon RPC request, which contains many fields including a separate field for the location of the user's profiles.

24.2.1 Samba Configuration for Profile Handling

This section documents how to configure Samba for MS Windows client profile support.

24.2.1.1 NT4/200x User Profiles

For example, to support Windows NT4/200x clients, set the following in the [global] section of the `smb.conf` file:

```
logon path = \\profilesver\profileshare\profilepath\%U\moreprofilepath
```

This is typically implemented like: `logon path = \\%L\Profiles\%u` where “%L” translates to the name of the Samba server and “%u” translates to the user name.

The default for this option is `\\%N\%U\profile`, namely `\\sambaserver\username\profile`. The `\\%N\%U` service is created automatically by the [homes] service. If you are using a Samba server for the profiles, you must make the share that is specified in the logon path browseable. Please refer to the man page for `smb.conf` in respect of the different semantics of “%L” and “%N”, as well as “%U” and “%u”.

NOTE



MS Windows NT/200x clients at times do not disconnect a connection to a server between logons. It is recommended to not use the `homes` meta-service name as part of the profile share path.

24.2.1.2 Windows 9x/Me User Profiles

To support Windows 9x/Me clients, you must use the logon home parameter. Samba has been fixed so `net use /home` now works as well and it, too, relies on the **logon home** parameter.

By using the logon home parameter, you are restricted to putting Windows 9x/Me profiles in the user's home directory. But wait! There is a trick you can use. If you set the following in the [global] section of your `smb.conf` file:

```
logon home = \\%L\%U\profiles
```

then your Windows 9x/Me clients will dutifully put their clients in a subdirectory of your home directory called `.profiles` (making them hidden).

Not only that, but `net use /home` will also work because of a feature in Windows 9x/Me. It removes any directory stuff off the end of the home directory area and only uses the server and share portion. That is, it looks like you specified `\\%L%\%U` for logon home.

24.2.1.3 Mixed Windows 9x/Me and Windows NT4/200x User Profiles

You can support profiles for Windows 9x and Windows NT clients by setting both the logon home and logon path parameters. For example:

```
logon home = \\%L%\%u\.profiles
logon path = \\%L\profiles\%u
```

24.2.1.4 Disabling Roaming Profile Support

A question often asked is: “*How may I enforce use of local profiles?*” or “*How do I disable roaming profiles?*”

There are three ways of doing this:

In `smb.conf` Affect the following settings and ALL clients will be forced to use a local profile: `logon home =` and `logon path =`

The arguments to these parameters must be left blank. It is necessary to include the `=` sign to specifically assign the empty value.

MS Windows Registry By using the Microsoft Management Console `gpedit.msc` to instruct your MS Windows XP machine to use only a local profile. This, of course, modifies registry settings. The full path to the option is:

```
Local Computer Policy\
  Computer Configuration\
    Administrative Templates\
      System\
        User Profiles\
```

Disable: Only Allow Local User Profiles

Disable: Prevent Roaming Profile Change from Propagating to the Server

Change of Profile Type: From the start menu right-click on **My Computer icon**, select **Properties**, click on the **User Profiles** tab, select the profile you wish to change from **Roaming** type to **Local**, and click on **Change Type**.

Consult the MS Windows registry guide for your particular MS Windows version for more information about which registry keys to change to enforce use of only local user profiles.

NOTE



The specifics of how to convert a local profile to a roaming profile, or a roaming profile to a local one vary according to the version of MS Windows you are running. Consult the Microsoft MS Windows Resource Kit for your version of Windows for specific information.

24.2.2 Windows Client Profile Configuration Information

24.2.2.1 Windows 9x/Me Profile Setup

When a user first logs in on Windows 9X, the file `user.DAT` is created, as are folders `Start Menu`, `Desktop`, `Programs`, and `Nethood`. These directories and their contents will be merged with the local versions stored in `c:\windows\profiles\username` on subsequent logins, taking the most recent from each. You will need to use the *[global]* options `preserve case = yes`, `short preserve case = yes` and `case sensitive = no` in order to maintain capital letters in shortcuts in any of the profile folders.

The `user.DAT` file contains all the user's preferences. If you wish to enforce a set of preferences, rename their `user.DAT` file to `user.MAN`, and deny them write access to this file.

1. On the Windows 9x/Me machine, go to **Control Panel** -> **Passwords** and select the **User Profiles** tab. Select the required level of roaming preferences. Press **OK**, but do not allow the computer to reboot.
2. On the Windows 9x/Me machine, go to **Control Panel** -> **Network** -> **Client for Microsoft Networks** -> **Preferences**. Select **Log on to NT Domain**. Then, ensure that the Primary Logon is **Client for Microsoft Networks**. Press **OK**, and this time allow the computer to reboot.

Under Windows 9x/ME, profiles are downloaded from the Primary Logon. If you have the Primary Logon as "*Client for Novell Networks*", then the profiles and logon script will be downloaded from your Novell Server. If you have the Primary Logon as "*Windows Logon*", then the profiles will be loaded from the local machine — a bit against the concept of roaming profiles, it would seem!

You will now find that the Microsoft Networks Login box contains `[user, password, domain]` instead of just `[user, password]`. Type in the Samba server's domain name (or any other domain known to exist, but bear in mind that the user will be authenticated against this domain and profiles downloaded from it, if that domain logon server supports it), user name and user's password.

Once the user has been successfully validated, the Windows 9x/Me machine will inform you that **The user has not logged on before** and asks you **Do you wish to save the user's preferences?** Select **Yes**.

Once the Windows 9x/Me client comes up with the desktop, you should be able to examine the contents of the directory specified in the logon path on the Samba server and verify that the **Desktop**, **Start Menu**, **Programs** and **Nethood** folders have been created.

These folders will be cached locally on the client, and updated when the user logs off (if you haven't made them read-only by then). You will find that if the user creates further folders or shortcut, that the client will merge the profile contents downloaded with the contents of the profile directory already on the local client, taking the newest folders and shortcut from each set.

If you have made the folders/files read-only on the Samba server, then you will get errors from the Windows 9x/Me machine on logon and logout as it attempts to merge the local and remote profile. Basically, if you have any errors reported by the Windows 9x/Me machine, check the UNIX file permissions and ownership rights on the profile directory contents, on the Samba server.

If you have problems creating user profiles, you can reset the user's local desktop cache, as shown below. When this user next logs in, the user will be told that he/she is logging in "*for the first time*".

1. Instead of logging in under the [user, password, domain] dialog, press **escape**.
2. Run the **regedit.exe** program, and look in:

```
HKEY_LOCAL_MACHINE\Windows\CurrentVersion\ProfileList
```

You will find an entry for each user of ProfilePath. Note the contents of this key (likely to be `c:\windows\profiles\username`), then delete the key *ProfilePath* for the required user.

3. Exit the registry editor.
4. Search for the user's .PWL password-caching file in the `c:\windows` directory, and delete it.
5. Log off the Windows 9x/Me client.
6. Check the contents of the profile path (see logon path described above) and delete the `user.DAT` or `user.MAN` file for the user, making a backup if required.

WARNING

Before deleting the contents of the directory listed in the *ProfilePath* (this is likely to be `c:\windows\profiles\username`), ask the owner if they have any important files stored on their desktop or in their start menu. Delete the contents of the directory *ProfilePath* (making a backup if any of the files are needed).

This will have the effect of removing the local (read-only hidden system file) `user.DAT` in their profile directory, as well as the local "*desktop*," "*nethood*," "*start menu*," and "*programs*" folders.

If all else fails, increase Samba's debug log levels to between 3 and 10, and/or run a packet sniffer program such as ethereal or **netmon.exe**, and look for error messages.

If you have access to an Windows NT4/200x server, then first set up roaming profiles and/or netlogons on the Windows NT4/200x server. Make a packet trace, or examine the example packet traces provided with Windows NT4/200x server, and see what the differences are with the equivalent Samba trace.

24.2.2.2 Windows NT4 Workstation

When a user first logs in to a Windows NT Workstation, the profile NTuser.DAT is created. The profile location can be now specified through the logon path parameter.

There is a parameter that is now available for use with NT Profiles: logon drive. This should be set to H: or any other drive, and should be used in conjunction with the new logon home parameter.

The entry for the NT4 profile is a directory not a file. The NT help on Profiles mentions that a directory is also created with a .PDS extension. The user, while logging in, must have write permission to create the full profile path (and the folder with the .PDS extension for those situations where it might be created.)

In the profile directory, Windows NT4 creates more folders than Windows 9x/Me. It creates **Application Data** and others, as well as **Desktop**, **Nethood**, **Start Menu**, and **Programs**. The profile itself is stored in a file NTuser.DAT. Nothing appears to be stored in the .PDS directory, and its purpose is currently unknown.

You can use the System Control Panel to copy a local profile onto a Samba server (see NT Help on Profiles; it is also capable of firing up the correct location in the System Control Panel for you). The NT Help file also mentions that renaming NTuser.DAT to NTuser.MAN turns a profile into a mandatory one.

The case of the profile is significant. The file must be called NTuser.DAT or, for a mandatory profile, NTuser.MAN.

24.2.2.3 Windows 2000/XP Professional

You must first convert the profile from a local profile to a domain profile on the MS Windows workstation as follows:

1. Log on as the *local* workstation administrator.
2. Right-click on the **My Computer** Icon, select **Properties**.
3. Click on the **User Profiles** tab.
4. Select the profile you wish to convert (click it once).
5. Click on the **Copy To** button.
6. In the **Permitted to use** box, click on the **Change** button.

7. Click on the **Look in** area that lists the machine name. When you click here, it will open up a selection box. Click on the domain to which the profile must be accessible.

NOTE

You will need to log on if a logon box opens up. For example, connect as *DOMAIN*\root, password: *mypassword*.

8. To make the profile capable of being used by anyone, select “*Everyone*”.
 9. Click on **OK** and the Selection box will close.
 10. Now click on **OK** to create the profile in the path you nominated.
- Done. You now have a profile that can be edited using the Samba **profiles** tool.

NOTE

Under Windows NT/200x, the use of mandatory profiles forces the use of MS Exchange storage of mail data and keeps it out of the desktop profile. That keeps desktop profiles from becoming unusable.

Windows XP Service Pack 1 There is a security check new to Windows XP (or maybe only Windows XP service pack 1). It can be disabled via a group policy in the Active Directory. The policy is called:

Computer Configuration\Administrative Templates\System\User Profiles\
Do not check for user ownership of Roaming Profile Folders

This should be set to **Enabled**.

Does the new version of Samba have an Active Directory analogue? If so, then you may be able to set the policy through this.

If you cannot set group policies in Samba, then you may be able to set the policy locally on each machine. If you want to try this, then do the following (N.B. I do not know for sure that this will work in the same way as a domain group policy):

1. On the XP workstation, log in with an Administrative account.
2. Click on **Start -> Run**.
3. Type **mmc**.
4. Click on **OK**.
5. A Microsoft Management Console should appear.

6. Click on **File** -> **Add/Remove Snap-in** -> **Add**.
7. Double-click on **Group Policy**.
8. Click on **Finish** -> **Close**.
9. Click on **OK**.
10. In the “*Console Root*” window expand **Local Computer Policy** -> **Computer Configuration** -> **Administrative Templates** -> **System** -> **User Profiles**.
11. Double-click on **Do not check for user ownership of Roaming Profile Folders**.
12. Select **Enabled**.
13. Click on **OK**.
14. Close the whole console. You do not need to save the settings (this refers to the console settings rather than the policies you have changed).
15. Reboot.

24.2.3 Sharing Profiles between W9x/Me and NT4/200x/XP Workstations

Sharing of desktop profiles between Windows versions is not recommended. Desktop profiles are an evolving phenomenon and profiles for later versions of MS Windows clients add features that may interfere with earlier versions of MS Windows clients. Probably the more salient reason to not mix profiles is that when logging off an earlier version of MS Windows, the older format of profile contents may overwrite information that belongs to the newer version resulting in loss of profile information content when that user logs on again with the newer version of MS Windows.

If you then want to share the same Start Menu/Desktop with W9x/Me, you will need to specify a common location for the profiles. The `smb.conf` parameters that need to be common are `logon path` and `logon home`.

If you have this set up correctly, you will find separate `user.DAT` and `NTuser.DAT` files in the same profile directory.

24.2.4 Profile Migration from Windows NT4/200x Server to Samba

There is nothing to stop you from specifying any path that you like for the location of users' profiles. Therefore, you could specify that the profile be stored on a Samba server, or any other SMB server, as long as that SMB server supports encrypted passwords.

24.2.4.1 Windows NT4 Profile Management Tools

Unfortunately, the Resource Kit information is specific to the version of MS Windows NT4/200x. The correct resource kit is required for each platform.

Here is a quick guide:

1. On your NT4 Domain Controller, right click on **My Computer**, then select the tab labeled **User Profiles**.
2. Select a user profile you want to migrate and click on it.

NOTE



I am using the term “*migrate*” loosely. You can copy a profile to create a group profile. You can give the user *Everyone* rights to the profile you copy this to. That is what you need to do, since your Samba domain is not a member of a trust relationship with your NT4 PDC.

3. Click on the **Copy To** button.
4. In the box labeled **Copy Profile to** add your new path, e.g., `c:\temp\foobar`
5. Click on **Change** in the **Permitted to use** box.
6. Click on the group “*Everyone*”, click on **OK**. This closes the “*choose user*” box.
7. Now click on **OK**.

Follow the above for every profile you need to migrate.

24.2.4.2 Side Bar Notes

You should obtain the SID of your NT4 domain. You can use `smbpasswd` to do this. Read the man page.

24.2.4.3 moveuser.exe

The Windows 200x professional resource kit has **moveuser.exe**. **moveuser.exe** changes the security of a profile from one user to another. This allows the account domain to change, and/or the user name to change.

This command is like the Samba **profiles** tool.

24.2.4.4 Get SID

You can identify the SID by using **GetSID.exe** from the Windows NT Server 4.0 Resource Kit.

Windows NT 4.0 stores the local profile information in the registry under the following key: `HKEY_LOCAL_MACHINE\SOFTWARE\Microsoft\Windows NT\CurrentVersion\ProfileList`

Under the `ProfileList` key, there will be subkeys named with the SIDs of the users who have logged on to this computer. (To find the profile information for the user whose locally cached profile you want to move, find the SID for the user with the **GetSID.exe** utility.) Inside the appropriate user’s subkey, you will see a string value named *ProfileImagePath*.

24.3 Mandatory Profiles

A Mandatory Profile is a profile that the user does not have the ability to overwrite. During the user's session, it may be possible to change the desktop environment, however, as the user logs out all changes made will be lost. If it is desired to not allow the user any ability to change the desktop environment, then this must be done through policy settings. See the previous chapter.

NOTE



Under NO circumstances should the profile directory (or its contents) be made read-only as this may render the profile un-usable. Where it is essential to make a profile read-only within the UNIX file system, this can be done but then you absolutely must use the **fake-permissions** VFS module to instruct MS Windows NT/200x/XP clients that the Profile has write permission for the user. See `fake_perms` VFS module.

For MS Windows NT4/200x/XP, the above method can also be used to create mandatory profiles. To convert a group profile into a mandatory profile, simply locate the `NTUser.DAT` file in the copied profile and rename it to `NTUser.MAN`.

For MS Windows 9x/ME, it is the `User.DAT` file that must be renamed to `User.MAN` to effect a mandatory profile.

24.4 Creating and Managing Group Profiles

Most organizations are arranged into departments. There is a nice benefit in this fact since usually most users in a department require the same desktop applications and the same desktop layout. MS Windows NT4/200x/XP will allow the use of Group Profiles. A Group Profile is a profile that is created first using a template (example) user. Then using the profile migration tool (see above), the profile is assigned access rights for the user group that needs to be given access to the group profile.

The next step is rather important. Instead of assigning a group profile to users (Using User Manager) on a “*per user*” basis, the group itself is assigned the now modified profile.

NOTE



Be careful with Group Profiles. If the user who is a member of a group also has a personal profile, then the result will be a fusion (merge) of the two.

24.5 Default Profile for Windows Users

MS Windows 9x/Me and NT4/200x/XP will use a default profile for any user for whom a profile does not already exist. Armed with a knowledge of where the default profile is located on the Windows workstation, and knowing which registry keys effect the path from which the default profile is created, it is possible to modify the default profile to one that has been optimized for the site. This has significant administrative advantages.

24.5.1 MS Windows 9x/Me

To enable default per use profiles in Windows 9x/ME, you can either use the Windows 98 System Policy Editor or change the registry directly.

To enable default per user profiles in Windows 9x/ME, launch the System Policy Editor, then select **File -> Open Registry**, next click on the **Local Computer** icon, click on **Windows 98 System**, select **User Profiles**, and click on the enable box. Remember to save the registry changes.

To modify the registry directly, launch the Registry Editor (**regedit.exe**) and select the hive `HKEY_LOCAL_MACHINE\Network\Logon`. Now add a DWORD type key with the name “*User Profiles*,” to enable user profiles to set the value to 1; to disable user profiles set it to 0.

24.5.1.1 User Profile Handling with Windows 9x/Me

When a user logs on to a Windows 9x/Me machine, the local profile path, `HKEY_LOCAL_MACHINE\Software\Microsoft\Windows\CurrentVersion\ProfileList`, is checked for an existing entry for that user.

If the user has an entry in this registry location, Windows 9x/Me checks for a locally cached version of the user profile. Windows 9x/Me also checks the user’s home directory (or other specified directory if the location has been modified) on the server for the User Profile. If a profile exists in both locations, the newer of the two is used. If the User Profile exists on the server, but does not exist on the local machine, the profile on the server is downloaded and used. If the User Profile only exists on the local machine, that copy is used.

If a User Profile is not found in either location, the Default User Profile from the Windows 9x/Me machine is used and copied to a newly created folder for the logged on user. At log off, any changes that the user made are written to the user’s local profile. If the user has a roaming profile, the changes are written to the user’s profile on the server.

24.5.2 MS Windows NT4 Workstation

On MS Windows NT4, the default user profile is obtained from the location `%System-Root%\Profiles` which in a default installation will translate to `C:\Windows NT\Profiles`. Under this directory on a clean install there will be three (3) directories: **Administrator**, **All Users**, and **Default User**.

The **All Users** directory contains menu settings that are common across all system users. The **Default User** directory contains menu entries that are customizable per user depending on the profile settings chosen/created.

When a new user first logs onto an MS Windows NT4 machine, a new profile is created from:

- All Users settings.
- Default User settings (contains the default `NTuser.DAT` file).

When a user logs onto an MS Windows NT4 machine that is a member of a Microsoft security domain, the following steps are followed in respect of profile handling:

1. The users' account information that is obtained during the logon process contains the location of the users' desktop profile. The profile path may be local to the machine or it may be located on a network share. If there exists a profile at the location of the path from the user account, then this profile is copied to the location `%SystemRoot%\Profiles\%USERNAME%`. This profile then inherits the settings in the **All Users** profile in the `%SystemRoot%\Profiles` location.
2. If the user account has a profile path, but at its location a profile does not exist, then a new profile is created in the `%SystemRoot%\Profiles\%USERNAME%` directory from reading the **Default User** profile.
3. If the **NETLOGON** share on the authenticating server (logon server) contains a policy file (`NTConfig.POL`), then its contents are applied to the `NTuser.DAT` which is applied to the `HKEY_CURRENT_USER` part of the registry.
4. When the user logs out, if the profile is set to be a roaming profile it will be written out to the location of the profile. The `NTuser.DAT` file is then recreated from the contents of the `HKEY_CURRENT_USER` contents. Thus, should there not exist in the **NETLOGON** share an `NTConfig.POL` at the next logon, the effect of the previous `NTConfig.POL` will still be held in the profile. The effect of this is known as tattooing.

MS Windows NT4 profiles may be *local* or *roaming*. A local profile will be stored in the `%SystemRoot%\Profiles\%USERNAME%` location. A roaming profile will also remain stored in the same way, unless the following registry key is created as shown:

```
HKEY_LOCAL_MACHINE\SYSTEM\Software\Microsoft\Windows NT\CurrentVersion\  
winlogon\DeleteRoamingCache=dword:0000000
```

In this case, the local copy (in `%SystemRoot%\Profiles\%USERNAME%`) will be deleted on logout.

Under MS Windows NT4, default locations for common resources like **My Documents** may be redirected to a network share by modifying the following registry keys. These changes may be affected via use of the System Policy Editor. To do so may require that you create your own template extension for the policy editor to allow this to be done through the GUI. Another way to do this is by way of first creating a default user profile, then while logged in as that user, run **regedt32** to edit the key settings.

The Registry Hive key that affects the behavior of folders that are part of the default user profile are controlled by entries on Windows NT4 is:

```
HKEY_CURRENT_USER
  \Software
    \Microsoft
      \Windows
        \CurrentVersion
          \Explorer
            \User Shell Folders
```

The above hive key contains a list of automatically managed folders. The default entries are shown in the next table.

Table 24.1. User Shell Folder Registry Keys Default Values

Name	Default Value
AppData	%USERPROFILE%\Application Data
Desktop	%USERPROFILE%\Desktop
Favorites	%USERPROFILE%\Favorites
NetHood	%USERPROFILE%\NetHood
PrintHood	%USERPROFILE%\PrintHood
Programs	%USERPROFILE%\Start Menu\Programs
Recent	%USERPROFILE%\Recent
SendTo	%USERPROFILE%\SendTo
Start Menu	%USERPROFILE%\Start Menu
Startup	%USERPROFILE%\Start Menu\Programs\Startup

The registry key that contains the location of the default profile settings is:

```
HKEY_LOCAL_MACHINE\SOFTWARE\Microsoft\Windows\CurrentVersion\Explorer\
User Shell Folders
```

The default entries are shown in the next table.

Table 24.2. Defaults of Profile Settings Registry Keys

Common Desktop	%SystemRoot%\Profiles\All Users\Desktop
Common Programs	%SystemRoot%\Profiles\All Users\Programs
Common Start Menu	%SystemRoot%\Profiles\All Users\Start Menu
Common Startup	%SystemRoot%\Profiles\All Users\Start Menu\Programs\Startup

24.5.3 MS Windows 200x/XP

NOTE



MS Windows XP Home Edition does use default per user profiles, but cannot participate in domain security, cannot log onto an NT/ADS-style domain, and thus can obtain the profile only from itself. While there are benefits in doing this, the beauty of those MS Windows clients that can participate in domain logon processes allows the administrator to create a global default profile and enforce it through the use of Group Policy Objects (GPOs).

When a new user first logs onto an MS Windows 200x/XP machine, the default profile is obtained from `C:\Documents and Settings\Default User`. The administrator can modify or change the contents of this location and MS Windows 200x/XP will gladly use it. This is far from the optimum arrangement since it will involve copying a new default profile to every MS Windows 200x/XP client workstation.

When MS Windows 200x/XP participates in a domain security context, and if the default user profile is not found, then the client will search for a default profile in the NETLOGON share of the authenticating server. In MS Windows parlance, `%LOGONSERVER%\NETLOGON\Default User`, and if one exists there it will copy this to the workstation to the `C:\Documents and Settings\` under the Windows login name of the user.

NOTE



This path translates, in Samba parlance, to the `smb.conf [NETLOGON]` share. The directory should be created at the root of this share and must be called `Default Profile`.

If a default profile does not exist in this location, then MS Windows 200x/XP will use the local default profile.

On logging out, the users' desktop profile will be stored to the location specified in the registry settings that pertain to the user. If no specific policies have been created or passed to the client during the login process (as Samba does automatically), then the user's profile will be written to the local machine only under the path `C:\Documents and Settings\%USERNAME%`.

Those wishing to modify the default behavior can do so through these three methods:

- Modify the registry keys on the local machine manually and place the new default profile in the NETLOGON share root. This is not recommended as it is maintenance intensive.
- Create an NT4-style NTConfig.POL file that specified this behavior and locate this

file in the root of the NETLOGON share along with the new default profile.

- Create a GPO that enforces this through Active Directory, and place the new default profile in the NETLOGON share.

The registry hive key that effects the behavior of folders that are part of the default user profile are controlled by entries on Windows 200x/XP is:

HKEY_CURRENT_USER\Software\Microsoft\Windows\CurrentVersion\Explorer\User Shell Folders\

The above hive key contains a list of automatically managed folders. The default entries are shown in the next table

Table 24.3. Defaults of Default User Profile Paths Registry Keys

Name	Default Value
AppData	%USERPROFILE%\Application Data
Cache	%USERPROFILE%\Local Settings\Temporary Internet Files
Cookies	%USERPROFILE%\Cookies
Desktop	%USERPROFILE%\Desktop
Favorites	%USERPROFILE%\Favorites
History	%USERPROFILE%\Local Settings\History
Local AppData	%USERPROFILE%\Local Settings\Application Data
Local Settings	%USERPROFILE%\Local Settings
My Pictures	%USERPROFILE%\My Documents\My Pictures
NetHood	%USERPROFILE%\NetHood
Personal	%USERPROFILE%\My Documents
PrintHood	%USERPROFILE%\PrintHood
Programs	%USERPROFILE%\Start Menu\Programs
Recent	%USERPROFILE%\Recent
SendTo	%USERPROFILE%\SendTo
Start Menu	%USERPROFILE%\Start Menu
Startup	%USERPROFILE%\Start Menu\Programs\Startup
Templates	%USERPROFILE%\Templates

There is also an entry called “*Default*” that has no value set. The default entry is of type REG_SZ, all the others are of type REG_EXPAND_SZ.

It makes a huge difference to the speed of handling roaming user profiles if all the folders are stored on a dedicated location on a network server. This means that it will not be necessary to write the Outlook PST file over the network for every login and logout.

To set this to a network location, you could use the following examples:

```
%LOGONSERVER%\%USERNAME%\Default Folders
```

This would store the folders in the user’s home directory under a directory called **Default Folders**. You could also use:

```
\\SambaServer\FolderShare\%USERNAME%
```

in which case the default folders will be stored in the server named *SambaServer* in the share called *FolderShare* under a directory that has the name of the MS Windows user as seen by the Linux/UNIX file system.

Please note that once you have created a default profile share, you MUST migrate a user's profile (default or custom) to it.

MS Windows 200x/XP profiles may be *Local* or *Roaming*. A roaming profile will be cached locally unless the following registry key is created:

```
HKEY_LOCAL_MACHINE\SYSTEM\Software\Microsoft\Windows NT\CurrentVersion\  
winlogon\DeleteRoamingCache=dword:00000001
```

In this case, the local cache copy will be deleted on logout.

24.6 Common Errors

The following are some typical errors, problems and questions that have been asked on the Samba mailing lists.

24.6.1 Configuring Roaming Profiles for a Few Users or Groups

With Samba-2.2.x, the choice you have is to enable or disable roaming profiles support. It is a global only setting. The default is to have roaming profiles and the default path will locate them in the user's home directory.

If disabled globally, then no one will have roaming profile ability. If enabled and you want it to apply only to certain machines, then on those machines on which roaming profile support is not wanted it is then necessary to disable roaming profile handling in the registry of each such machine.

With Samba-3, you can have a global profile setting in `smb.conf` and you can override this by per-user settings using the Domain User Manager (as with MS Windows NT4/ Win 200xx).

In any case, you can configure only one profile per user. That profile can be either:

- A profile unique to that user.
- A mandatory profile (one the user cannot change).
- A group profile (really should be mandatory, that is unchangable).

24.6.2 Cannot Use Roaming Profiles

A user requested the following: *"I do not want Roaming profiles to be implemented. I want to give users a local profile alone. Please help me, I am totally lost with this error. For the past two days I tried everything, I googled around but found no useful pointers. Please help me."*

The choices are:

Local profiles I know of no registry keys that will allow auto-deletion of LOCAL profiles on log out.

Roaming profiles As a user logs onto the network, a centrally stored profile is copied to the workstation to form a local profile. This local profile will persist (remain on the workstation disk) unless a registry key is changed that will cause this profile to be automatically deleted on logout.

The roaming profile choices are:

Personal roaming profiles These are typically stored in a profile share on a central (or conveniently located local) server.

Workstations cache (store) a local copy of the profile. This cached copy is used when the profile cannot be downloaded at next logon.

Group profiles These are loaded from a central profile server.

Mandatory profiles Mandatory profiles can be created for a user as well as for any group that a user is a member of. Mandatory profiles cannot be changed by ordinary users. Only the administrator can change or reconfigure a mandatory profile.

A Windows NT4/200x/XP profile can vary in size from 130KB to very large. Outlook PST files are most often part of the profile and can be many GB in size. On average (in a well controlled environment), roaming profile size of 2MB is a good rule of thumb to use for planning purposes. In an undisciplined environment, I have seen up to 2GB profiles. Users tend to complain when it takes an hour to log onto a workstation but they harvest the fruits of folly (and ignorance).

The point of all the above is to show that roaming profiles and good controls of how they can be changed as well as good discipline make up for a problem-free site.

Microsoft's answer to the PST problem is to store all email in an MS Exchange Server backend. This removes the need for a PST file.

Local profiles mean:

- If each machine is used by many users, then much local disk storage is needed for local profiles.
- Every workstation the user logs into has its own profile; these can be very different from machine to machine.

On the other hand, use of roaming profiles means:

- The network administrator can control the desktop environment of all users.
- Use of mandatory profiles drastically reduces network management overheads.
- In the long run, users will experience fewer problems.

24.6.3 Changing the Default Profile

“When the client logs onto the Domain Controller, it searches for a profile to download. Where do I put this default profile?”

First, the Samba server needs to be configured as a Domain Controller. This can be done by setting in `smb.conf`:

```
security = user
os level = 32 (or more)
domain logons = Yes
```

There must be a `[netlogon]` share that is world readable. It is a good idea to add a logon script to pre-set printer and drive connections. There is also a facility for automatically synchronizing the workstation time clock with that of the logon server (another good thing to do).

NOTE



To invoke auto-deletion of roaming profile from the local workstation cache (disk storage), use the Group Policy Editor to create a file called `NTConfig.POL` with the appropriate entries. This file needs to be located in the `netlogon` share root directory.

Windows clients need to be members of the domain. Workgroup machines do not use network logons so they do not interoperate with domain profiles.

For roaming profiles, add to `smb.conf`:

```
logon path = \\%N\profiles\%U
# Default logon drive is Z:
logon drive = H:
# This requires a PROFILES share that is world writable.
```

PAM-BASED DISTRIBUTED AUTHENTICATION

This chapter should help you to deploy Winbind-based authentication on any PAM-enabled UNIX/Linux system. Winbind can be used to enable User-Level application access authentication from any MS Windows NT Domain, MS Windows 200x Active Directory-based domain, or any Samba-based domain environment. It will also help you to configure PAM-based local host access controls that are appropriate to your Samba configuration.

In addition to knowing how to configure Winbind into PAM, you will learn generic PAM management possibilities and in particular how to deploy tools like `pam_smbpass.so` to your advantage.

NOTE



The use of Winbind requires more than PAM configuration alone. Please refer to *Winbind: Use of Domain Accounts*, for further information regarding Winbind.

25.1 Features and Benefits

A number of UNIX systems (e.g., Sun Solaris), as well as the xxxxBSD family and Linux, now utilize the Pluggable Authentication Modules (PAM) facility to provide all authentication, authorization and resource control services. Prior to the introduction of PAM, a decision to use an alternative to the system password database (`/etc/passwd`) would require the provision of alternatives for all programs that provide security services. Such a choice would involve provision of alternatives to programs such as: **login**, **passwd**, **chown**, and so on.

PAM provides a mechanism that disconnects these security programs from the underlying authentication/authorization infrastructure. PAM is configured by making appropriate

modifications to one file `/etc/pam.conf` (Solaris), or by editing individual control files that are located in `/etc/pam.d`.

On PAM-enabled UNIX/Linux systems, it is an easy matter to configure the system to use any authentication backend so long as the appropriate dynamically loadable library modules are available for it. The backend may be local to the system, or may be centralized on a remote server.

PAM support modules are available for:

/etc/passwd There are several PAM modules that interact with this standard UNIX user database. The most common are called: `pam_unix.so`, `pam_unix2.so`, `pam_pwdb.so` and `pam_userdb.so`.

Kerberos The `pam_krb5.so` module allows the use of any Kerberos compliant server. This tool is used to access MIT Kerberos, Heimdal Kerberos, and potentially Microsoft Active Directory (if enabled).

LDAP The `pam_ldap.so` module allows the use of any LDAP v2 or v3 compatible backend server. Commonly used LDAP backend servers include: OpenLDAP v2.0 and v2.1, Sun ONE iIdentity server, Novell eDirectory server, Microsoft Active Directory.

NetWare Bindery The `pam_ncp_auth.so` module allows authentication off any bindery-enabled NetWare Core Protocol-based server.

SMB Password This module, called `pam_smbpass.so`, will allow user authentication off the `passwd` backend that is configured in the Samba `smb.conf` file.

SMB Server The `pam_smb_auth.so` module is the original MS Windows networking authentication tool. This module has been somewhat outdated by the Winbind module.

Winbind The `pam_winbind.so` module allows Samba to obtain authentication from any MS Windows Domain Controller. It can just as easily be used to authenticate users for access to any PAM-enabled application.

RADIUS There is a PAM RADIUS (Remote Access Dial-In User Service) authentication module. In most cases, administrators will need to locate the source code for this tool and compile and install it themselves. RADIUS protocols are used by many routers and terminal servers.

Of the above, Samba provides the `pam_smbpasswd.so` and the `pam_winbind.so` modules alone.

Once configured, these permit a remarkable level of flexibility in the location and use of distributed Samba Domain Controllers that can provide wide area network bandwidth efficient authentication services for PAM-capable systems. In effect, this allows the deployment

of centrally managed and maintained distributed authentication from a single-user account database.

25.2 Technical Discussion

PAM is designed to provide the system administrator with a great deal of flexibility in configuration of the privilege granting applications of their system. The local configuration of system security controlled by PAM is contained in one of two places: either the single system file, `/etc/pam.conf`, or the `/etc/pam.d/` directory.

25.2.1 PAM Configuration Syntax

In this section we discuss the correct syntax of and generic options respected by entries to these files. PAM-specific tokens in the configuration file are case insensitive. The module paths, however, are case sensitive since they indicate a file's name and reflect the case dependence of typical file systems. The case-sensitivity of the arguments to any given module is defined for each module in turn.

In addition to the lines described below, there are two special characters provided for the convenience of the system administrator: comments are preceded by a “`#`” and extend to the next end-of-line; also, module specification lines may be extended with a “`\`” escaped newline.

If the PAM authentication module (loadable link library file) is located in the default location, then it is not necessary to specify the path. In the case of Linux, the default location is `/lib/security`. If the module is located outside the default, then the path must be specified as:

```
auth required /other_path/pam_strange_module.so
```

25.2.1.1 Anatomy of `/etc/pam.d` Entries

The remaining information in this subsection was taken from the documentation of the Linux-PAM project. For more information on PAM, see The Official Linux-PAM home page. <<http://ftp.kernel.org/pub/linux/libs/pam/>>

A general configuration line of the `/etc/pam.conf` file has the following form:

```
service-name  module-type  control-flag  module-path  args
```

Below, we explain the meaning of each of these tokens. The second (and more recently adopted) way of configuring Linux-PAM is via the contents of the `/etc/pam.d/` directory. Once we have explained the meaning of the above tokens, we will describe this method.

service-name The name of the service associated with this entry. Frequently, the service name is the conventional name of the given application. For example, **ftpd**, **rlogind** and **su**, and so on.

There is a special service-name reserved for defining a default authentication mechanism. It has the name *OTHER* and may be specified in either lower- or upper-case characters. Note, when there is a module specified for a named service, the *OTHER* entries are ignored.

module-type One of (currently) four types of module. The four types are as follows:

- **auth**: This module type provides two aspects of authenticating the user. It establishes that the user is who he claims to be by instructing the application to prompt the user for a password or other means of identification. Secondly, the module can grant group membership (independently of the `/etc/groups` file discussed above) or other privileges through its credential granting properties.
- **account**: This module performs non-authentication-based account management. It is typically used to restrict/permit access to a service based on the time of day, currently available system resources (maximum number of users) or perhaps the location of the applicant user “*root*” login only on the console.
- **session**: Primarily, this module is associated with doing things that need to be done for the user before and after they can be given service. Such things include the logging of information concerning the opening and closing of some data exchange with a user, mounting directories, and so on.
- **password**: This last module type is required for updating the authentication token associated with the user. Typically, there is one module for each “*challenge/response*” -based authentication (*auth*) module type.

control-flag The control-flag is used to indicate how the PAM library will react to the success or failure of the module it is associated with. Since modules can be stacked (modules of the same type execute in series, one after another), the control-flags determine the relative importance of each module. The application is not made aware of the individual success or failure of modules listed in the `/etc/pam.conf` file. Instead, it receives a summary success or fail response from the Linux-PAM library. The order of execution of these modules is that of the entries in the `/etc/pam.conf` file; earlier entries are executed before later ones. As of Linux-PAM v0.60, this control-flag can be defined with one of two syntaxes.

The simpler (and historical) syntax for the control-flag is a single keyword defined to indicate the severity of concern associated with the success or failure of a specific module. There are four such keywords: *required*, *requisite*, *sufficient* and *optional*.

The Linux-PAM library interprets these keywords in the following manner:

- **required**: This indicates that the success of the module is required for the

module-type facility to succeed. Failure of this module will not be apparent to the user until all of the remaining modules (of the same module-type) have been executed.

- *requisite*: Like required, however, in the case that such a module returns a failure, control is directly returned to the application. The return value is that associated with the first required or requisite module to fail. This flag can be used to protect against the possibility of a user getting the opportunity to enter a password over an unsafe medium. It is conceivable that such behavior might inform an attacker of valid accounts on a system. This possibility should be weighed against the not insignificant concerns of exposing a sensitive password in a hostile environment.
- *sufficient*: The success of this module is deemed *sufficient* to satisfy the Linux-PAM library that this module-type has succeeded in its purpose. In the event that no previous required module has failed, no more “*stacked*” modules of this type are invoked. (In this case, subsequent required modules are not invoked). A failure of this module is not deemed as fatal to satisfying the application that this module-type has succeeded.
- *optional*: As its name suggests, this control-flag marks the module as not being critical to the success or failure of the user’s application for service. In general, Linux-PAM ignores such a module when determining if the module stack will succeed or fail. However, in the absence of any definite successes or failures of previous or subsequent stacked modules, this module will determine the nature of the response to the application. One example of this latter case, is when the other modules return something like PAM_IGNORE.

The more elaborate (newer) syntax is much more specific and gives the administrator a great deal of control over how the user is authenticated. This form of the control flag is delimited with square brackets and consists of a series of *value=action* tokens:

```
[value1=action1 value2=action2 ...]
```

Here, *value1* is one of the following return values:

```
success; open_err; symbol_err; service_err; system_err; buf_err;  
perm_denied; auth_err; cred_insufficient; authinfo_unavail;  
user_unknown; maxtries; new_authtok_reqd; acct_expired; session_err;  
cred_unavail; cred_expired; cred_err; no_module_data; conv_err;  
authtok_err; authtok_recover_err; authtok_lock_busy;  
authtok_disable_aging; try_again; ignore; abort; authtok_expired;  
module_unknown; bad_item; and default.
```

The last of these (*default*) can be used to set the action for those return values that are not explicitly defined.

The *action1* can be a positive integer or one of the following tokens: *ignore*; *ok*; *done*; *bad*; *die*; and *reset*. A positive integer, *J*, when specified as the action, can be used to indicate that the next *J* modules of the current module-type will be skipped. In this way, the administrator can develop a moderately sophisticated stack of modules with a number of different paths of execution. Which path is taken can be determined by the reactions of individual modules.

- *ignore*: When used with a stack of modules, the module's return status will not contribute to the return code the application obtains.
- *bad*: This action indicates that the return code should be thought of as indicative of the module failing. If this module is the first in the stack to fail, its status value will be used for that of the whole stack.
- *die*: Equivalent to *bad* with the side effect of terminating the module stack and PAM immediately returning to the application.
- *ok*: This tells PAM that the administrator thinks this return code should contribute directly to the return code of the full stack of modules. In other words, if the former state of the stack would lead to a return of PAM_SUCCESS, the module's return code will override this value. Note, if the former state of the stack holds some value that is indicative of a modules failure, this *ok* value will not be used to override that value.
- *done*: Equivalent to *ok* with the side effect of terminating the module stack and PAM immediately returning to the application.
- *reset*: Clears all memory of the state of the module stack and starts again with the next stacked module.

Each of the four keywords: *required*; *requisite*; *sufficient*; and *optional*, have an equivalent expression in terms of the [...] syntax. They are as follows:

- *required* is equivalent to `[success=ok new_authtok_reqd=ok ignore=ignore default=bad]`.
- *requisite* is equivalent to `[success=ok new_authtok_reqd=ok ignore=ignore default=die]`.
- *sufficient* is equivalent to `[success=done new_authtok_reqd=done default=ignore]`.
- *optional* is equivalent to `[success=ok new_authtok_reqd=ok default=ignore]`.

Just to get a feel for the power of this new syntax, here is a taste of what you can do with it. With Linux-PAM-0.63, the notion of client plug-in agents was introduced. This is something that makes it possible for PAM to support machine-machine authentication using the transport protocol inherent to the client/server application. With the `[... value=action ...]` control syntax, it is possible for an application to be configured to support binary prompts with compliant clients, but to gracefully fall over into an alternative authentication mode for older, legacy applications.

module-path The path-name of the dynamically loadable object file; the pluggable module

itself. If the first character of the module path is “/”, it is assumed to be a complete path. If this is not the case, the given module path is appended to the default module path: `/lib/security` (but see the notes above).

The arguments are a list of tokens that are passed to the module when it is invoked, much like arguments to a typical Linux shell command. Generally, valid arguments are optional and are specific to any given module. Invalid arguments are ignored by a module, however, when encountering an invalid argument, the module is required to write an error to `syslog(3)`. For a list of generic options, see the next section.

If you wish to include spaces in an argument, you should surround that argument with square brackets. For example:

```
squid auth required pam_mysql.so user=passwd_query passwd=mada \
db=eminence [query=select user_name from internet_service where \
user_name=%u and password=PASSWORD(%p) and service=web_proxy]
```

When using this convention, you can include “`\"`” characters inside the string, and if you wish to have a “`\"`” character inside the string that will survive the argument parsing, you should use “`\\`”. In other words:

```
[..[..\]..] --> ..[.].
```

Any line in one of the configuration files that is not formatted correctly will generally tend (erring on the side of caution) to make the authentication process fail. A corresponding error is written to the system log files with a call to `syslog(3)`.

25.2.2 Example System Configurations

The following is an example `/etc/pam.d/login` configuration file. This example had all options uncommented and is probably not usable because it stacks many conditions before allowing successful completion of the login process. Essentially all conditions can be disabled by commenting them out, except the calls to `pam_pwdb.so`.

25.2.2.1 PAM: Original Login Config

```
##%PAM-1.0
# The PAM configuration file for the login service
#
auth        required    pam_securetty.so
auth        required    pam_nologin.so
# auth      required    pam_dialup.so
# auth      optional    pam_mail.so
```

```

auth          required    pam_pwdb.so shadow md5
# account     requisite   pam_time.so
account       required    pam_pwdb.so
session       required    pam_pwdb.so
# session     optional    pam_lastlog.so
# password    required    pam_cracklib.so retry=3
password      required    pam_pwdb.so shadow md5

```

25.2.2.2 PAM: Login Using pam_smbpass

PAM allows use of replaceable modules. Those available on a sample system include:

```
$/bin/ls /lib/security
```

```

pam_access.so    pam_ftp.so      pam_limits.so
pam_ncp_auth.so  pam_rhosts_auth.so pam_stress.so
pam_cracklib.so  pam_group.so    pam_listfile.so
pam_nologin.so   pam_rootok.so   pam_tally.so
pam_deny.so      pam_issue.so    pam_mail.so
pam_permit.so    pam_securetty.so pam_time.so
pam_dialup.so    pam_lastlog.so  pam_mkhome.so
pam_pwdb.so      pam_shells.so   pam_unix.so
pam_env.so       pam_ldap.so     pam_motd.so
pam_radius.so    pam_smbpass.so  pam_unix_acct.so
pam_wheel.so     pam_unix_auth.so pam_unix_passwd.so
pam_userdb.so    pam_warn.so     pam_unix_session.so

```

The following example for the login program replaces the use of the `pam_pwdb.so` module that uses the system password database (`/etc/passwd`, `/etc/shadow`, `/etc/group`) with the module `pam_smbpass.so`, which uses the Samba database which contains the Microsoft MD4 encrypted password hashes. This database is stored in either `/usr/local/samba/private/smbpasswd`, `/etc/samba/smbpasswd`, or in `/etc/samba.d/smbpasswd`, depending on the Samba implementation for your UNIX/Linux system. The `pam_smbpass.so` module is provided by Samba version 2.2.1 or later. It can be compiled by specifying the `--with-pam_smbpass` options when running Samba's `configure` script. For more information on the `pam_smbpass` module, see the documentation in the `source/pam_smbpass` directory of the Samba source distribution.

```

#%PAM-1.0
# The PAM configuration file for the login service
#
auth          required    pam_smbpass.so nodelay
account       required    pam_smbpass.so nodelay
session       required    pam_smbpass.so nodelay
password      required    pam_smbpass.so nodelay

```

The following is the PAM configuration file for a particular Linux system. The default condition uses `pam_pwdb.so`.

```

#%PAM-1.0
# The PAM configuration file for the samba service
#
auth      required      pam_pwdb.so nullok nodelay shadow audit
account   required      pam_pwdb.so audit nodelay
session   required      pam_pwdb.so nodelay
password  required      pam_pwdb.so shadow md5

```

In the following example, the decision has been made to use the `smbpasswd` database even for basic Samba authentication. Such a decision could also be made for the `passwd` program and would thus allow the `smbpasswd` passwords to be changed using the `passwd` program:

```

#%PAM-1.0
# The PAM configuration file for the samba service
#
auth      required      pam_smbpass.so nodelay
account   required      pam_pwdb.so audit nodelay
session   required      pam_pwdb.so nodelay
password  required      pam_smbpass.so nodelay smbconf=/etc/samba.d/smb.conf

```

NOTE



PAM allows stacking of authentication mechanisms. It is also possible to pass information obtained within one PAM module through to the next module in the PAM stack. Please refer to the documentation for your particular system implementation for details regarding the specific capabilities of PAM in this environment. Some Linux implementations also provide the `pam_stack.so` module that allows all authentication to be configured in a single central file. The `pam_stack.so` method has some devoted followers on the basis that it allows for easier administration. As with all issues in life though, every decision makes trade-offs, so you may want to examine the PAM documentation for further helpful information.

25.2.3 smb.conf PAM Configuration

There is an option in `smb.conf` called `obey pam restrictions`. The following is from the online help for this option in SWAT;

When Samba is configured to enable PAM support (i.e., `--with-pam`), this parameter will control whether or not Samba should obey PAM's account and session management directives. The default behavior is to use PAM for clear-text authentication only and to ignore any account or session management. Samba always ignores PAM for authentication in the case of encrypt passwords = yes. The reason is that PAM modules cannot support the challenge/response authentication mechanism needed in the presence of SMB password encryption.

Default: obey pam restrictions = no

25.2.4 Remote CIFS Authentication Using `winbindd.so`

All operating systems depend on the provision of users credentials acceptable to the platform. UNIX requires the provision of a user identifier (UID) as well as a group identifier (GID). These are both simple integer type numbers that are obtained from a password backend such as `/etc/passwd`.

Users and groups on a Windows NT server are assigned a relative ID (RID) which is unique for the domain when the user or group is created. To convert the Windows NT user or group into a UNIX user or group, a mapping between RIDs and UNIX user and group IDs is required. This is one of the jobs that `winbind` performs.

As `Winbind` users and groups are resolved from a server, user and group IDs are allocated from a specified range. This is done on a first come, first served basis, although all existing users and groups will be mapped as soon as a client performs a user or group enumeration command. The allocated UNIX IDs are stored in a database file under the Samba lock directory and will be remembered.

The astute administrator will realize from this that the combination of `pam_smbpass.so`, `winbindd` and a distributed `passwd` backend, such as `ldap`, will allow the establishment of a centrally managed, distributed user/password database that can also be used by all PAM-aware (e.g., Linux) programs and applications. This arrangement can have particularly potent advantages compared with the use of Microsoft Active Directory Service (ADS) in so far as the reduction of wide area network authentication traffic.

WARNING

The RID to UNIX ID database is the only location where the user and group mappings are stored by `winbindd`. If this file is deleted or corrupted, there is no way for `winbindd` to determine which user and group IDs correspond to Windows NT user and group RIDs.

25.2.5 Password Synchronization Using `pam_smbpass.so`

`pam_smbpass` is a PAM module that can be used on conforming systems to keep the `smb-`

`passwd` (Samba password) database in sync with the UNIX password file. PAM (Pluggable Authentication Modules) is an API supported under some UNIX operating systems, such as Solaris, HP-UX and Linux, that provides a generic interface to authentication mechanisms.

This module authenticates a local `smbpasswd` user database. If you require support for authenticating against a remote SMB server, or if you are concerned about the presence of SUID root binaries on your system, it is recommended that you use `pam.winbind` instead.

Options recognized by this module are shown in next table.

Table 25.1. Options recognized by `pam.smbpass`

<code>debug</code>	log more debugging info.
<code>audit</code>	like <code>debug</code> , but also logs unknown usernames.
<code>use_first_pass</code>	do not prompt the user for passwords; take them from PAM_ items instead.
<code>try_first_pass</code>	try to get the password from a previous PAM module fall back to prompting the user.
<code>use_authtok</code>	like <code>try_first_pass</code> , but <code>*fail*</code> if the new PAM_AUTHTOK has not been previously set (intended for stacking password modules only).
<code>not_set_pass</code>	do not make passwords used by this module available to other modules.
<code>nodelay</code>	do not insert ~1 second delays on authentication failure.
<code>nullok</code>	null passwords are allowed.
<code>nonnull</code>	null passwords are not allowed. Used to override the Samba configuration.
<code>migrate</code>	only meaningful in an “ <i>auth</i> ” context; used to update <code>smbpasswd</code> file with a password used for successful authentication.
<code>smbconf=filename</code>	specify an alternate path to the <code>smb.conf</code> file.

The following are examples of the use of `pam.smbpass.so` in the format of Linux `/etc/pam.d/` files structure. Those wishing to implement this tool on other platforms will need to adapt this appropriately.

25.2.5.1 Password Synchronization Configuration

A sample PAM configuration that shows the use of `pam.smbpass` to make sure `private/smbpasswd` is kept in sync when `/etc/passwd` (`/etc/shadow`) is changed. Useful when an expired password might be changed by an application (such as `ssh`).

```

#%PAM-1.0
# password-sync
#
auth      requisite    pam_nologin.so
auth      required     pam_unix.so
account   required     pam_unix.so
password  requisite     pam_cracklib.so retry=3
password  requisite     pam_unix.so shadow md5 use_authtok try_first_pass

```



```
password    required    pam_smbpass.so nullok use_authtok try_first_pass
session     required    pam_unix.so
```

25.2.5.2 Password Migration Configuration

A sample PAM configuration that shows the use of `pam_smbpass` to migrate from plaintext to encrypted passwords for Samba. Unlike other methods, this can be used for users who have never connected to Samba shares: password migration takes place when users **ftp** in, login using **ssh**, pop their mail, and so on.

```
#!/PAM-1.0
# password-migration
#
auth        requisite    pam_nologin.so
# pam_smbpass is called IF pam_unix succeeds.
auth        requisite    pam_unix.so
auth        optional     pam_smbpass.so migrate
account     required     pam_unix.so
password    requisite    pam_cracklib.so retry=3
password    requisite    pam_unix.so shadow md5 use_authtok try_first_pass
password    optional     pam_smbpass.so nullok use_authtok try_first_pass
session     required     pam_unix.so
```

25.2.5.3 Mature Password Configuration

A sample PAM configuration for a mature `smbpasswd` installation. `private/smbpasswd` is fully populated, and we consider it an error if the SMB password does not exist or does not match the UNIX password.

```
#!/PAM-1.0
# password-mature
#
auth        requisite    pam_nologin.so
auth        required     pam_unix.so
account     required     pam_unix.so
password    requisite    pam_cracklib.so retry=3
password    requisite    pam_unix.so shadow md5 use_authtok try_first_pass
password    required     pam_smbpass.so use_authtok use_first_pass
session     required     pam_unix.so
```

25.2.5.4 Kerberos Password Integration Configuration

A sample PAM configuration that shows *pam_smbpass* used together with *pam_krb5*. This could be useful on a Samba PDC that is also a member of a Kerberos realm.

```

#%PAM-1.0
# kdc-pdc
#
auth      requisite    pam_nologin.so
auth      requisite    pam_krb5.so
auth      optional    pam_smbpass.so migrate
account   required      pam_krb5.so
password  requisite      pam_cracklib.so retry=3
password  optional      pam_smbpass.so nullok use_authtok try_first_pass
password  required      pam_krb5.so use_authtok try_first_pass
session   required      pam_krb5.so

```

25.3 Common Errors

PAM can be fickle and sensitive to configuration glitches. Here we look at a few cases from the Samba mailing list.

25.3.1 pam_winbind Problem

A user reported: I have the following PAM configuration:

```

auth required /lib/security/pam_securetty.so
auth sufficient /lib/security/pam_winbind.so
auth sufficient /lib/security/pam_unix.so use_first_pass nullok
auth required /lib/security/pam_stack.so service=system-auth
auth required /lib/security/pam_nologin.so
account required /lib/security/pam_stack.so service=system-auth
account required /lib/security/pam_winbind.so
password required /lib/security/pam_stack.so service=system-auth

```

When I open a new console with [ctrl][alt][F1], I can't log in with my user "*pitie*". I have tried with user "*scienceu\pitie*" also.

Answer: The problem may lie with your inclusion of *pam_stack.so service=system-auth*. That file often contains a lot of stuff that may duplicate what you are already doing. Try commenting out the *pam_stack* lines for *auth* and *account* and see if things work. If they do, look at */etc/pam.d/system-auth* and copy only what you need from it into your */etc/pam.d/login* file. Alternately, if you want all services to use Winbind, you can put the Winbind-specific stuff in */etc/pam.d/system-auth*.

25.3.2 Winbind Is Not Resolving Users and Groups

*“My `smb.conf` file is correctly configured. I have specified `idmap uid = 12000`, and `idmap gid = 3000-3500` and **winbind** is running. When I do the following it all works fine.”*

```
root# wbinfo -u
MIDEARTH\maryo
MIDEARTH\jackb
MIDEARTH\ameds
...
MIDEARTH\root

root# wbinfo -g
MIDEARTH\Domain Users
MIDEARTH\Domain Admins
MIDEARTH\Domain Guests
...
MIDEARTH\Accounts

root# getent passwd
root:x:0:0:root:/root:/bin/bash
bin:x:1:1:bin:/bin:/bin/bash
...
maryo:x:15000:15003:Mary Orville:/home/MIDEARTH/maryo:/bin/false
```

“But this command fails:”

```
root# chown maryo a_file
chown: 'maryo': invalid user
```

“This is driving me nuts! What can be wrong?”

Answer: Your system is likely running **nscd**, the name service caching daemon. Shut it down, do not restart it! You will find your problem resolved.

INTEGRATING MS WINDOWS NETWORKS WITH SAMBA

This section deals with NetBIOS over TCP/IP name to IP address resolution. If your MS Windows clients are not configured to use NetBIOS over TCP/IP, then this section does not apply to your installation. If your installation involves the use of NetBIOS over TCP/IP then this section may help you to resolve networking problems.

NOTE



NetBIOS over TCP/IP has nothing to do with NetBEUI. NetBEUI is NetBIOS over Logical Link Control (LLC). On modern networks it is highly advised to not run NetBEUI at all. Note also there is no such thing as NetBEUI over TCP/IP — the existence of such a protocol is a complete and utter misapprehension.

26.1 Features and Benefits

Many MS Windows network administrators have never been exposed to basic TCP/IP networking as it is implemented in a UNIX/Linux operating system. Likewise, many UNIX and Linux administrators have not been exposed to the intricacies of MS Windows TCP/IP-based networking (and may have no desire to be either).

This chapter gives a short introduction to the basics of how a name can be resolved to its IP address for each operating system environment.

26.2 Background Information

Since the introduction of MS Windows 2000, it is possible to run MS Windows networking without the use of NetBIOS over TCP/IP. NetBIOS over TCP/IP uses UDP port 137 for

NetBIOS name resolution and uses TCP port 139 for NetBIOS session services. When NetBIOS over TCP/IP is disabled on MS Windows 2000 and later clients, then only the TCP port 445 will be used and the UDP port 137 and TCP port 139 will not.

NOTE



When using Windows 2000 or later clients, if NetBIOS over TCP/IP is not disabled, then the client will use UDP port 137 (NetBIOS Name Service, also known as the Windows Internet Name Service or WINS), TCP port 139 and TCP port 445 (for actual file and print traffic).

When NetBIOS over TCP/IP is disabled, the use of DNS is essential. Most installations that disable NetBIOS over TCP/IP today use MS Active Directory Service (ADS). ADS requires Dynamic DNS with Service Resource Records (SRV RR) and with Incremental Zone Transfers (IXFR). Use of DHCP with ADS is recommended as a further means of maintaining central control over the client workstation network configuration.

26.3 Name Resolution in a Pure UNIX/Linux World

The key configuration files covered in this section are:

- `/etc/hosts`
- `/etc/resolv.conf`
- `/etc/host.conf`
- `/etc/nsswitch.conf`

26.3.1 `/etc/hosts`

This file contains a static list of IP addresses and names.

```
127.0.0.1    localhost localhost.localdomain
192.168.1.1 bigbox.kenya.org bigbox    alias4box
```

The purpose of `/etc/hosts` is to provide a name resolution mechanism so users do not need to remember IP addresses.

Network packets that are sent over the physical network transport layer communicate not via IP addresses but rather using the Media Access Control address, or MAC address. IP addresses are currently 32 bits in length and are typically presented as four (4) decimal numbers that are separated by a dot (or period). For example, 168.192.1.1.

MAC Addresses use 48 bits (or 6 bytes) and are typically represented as two-digit hexadecimal numbers separated by colons: 40:8e:0a:12:34:56.

Every network interface must have a MAC address. Associated with a MAC address may be one or more IP addresses. There is no relationship between an IP address and a MAC address; all such assignments are arbitrary or discretionary in nature. At the most basic level, all network communications take place using MAC addressing. Since MAC addresses must be globally unique and generally remain fixed for any particular interface, the assignment of an IP address makes sense from a network management perspective. More than one IP address can be assigned per MAC address. One address must be the primary IP address — this is the address that will be returned in the ARP reply.

When a user or a process wants to communicate with another machine, the protocol implementation ensures that the “*machine name*” or “*host name*” is resolved to an IP address in a manner that is controlled by the TCP/IP configuration control files. The file `/etc/hosts` is one such file.

When the IP address of the destination interface has been determined, a protocol called ARP/RARP is used to identify the MAC address of the target interface. ARP stands for Address Resolution Protocol and is a broadcast-oriented method that uses User Datagram Protocol (UDP) to send a request to all interfaces on the local network segment using the all 1s MAC address. Network interfaces are programmed to respond to two MAC addresses only; their own unique address and the address `ff:ff:ff:ff:ff:ff`. The reply packet from an ARP request will contain the MAC address and the primary IP address for each interface.

The `/etc/hosts` file is foundational to all UNIX/Linux TCP/IP installations and as a minimum will contain the localhost and local network interface IP addresses and the primary names by which they are known within the local machine. This file helps to prime the pump so a basic level of name resolution can exist before any other method of name resolution becomes available.

26.3.2 `/etc/resolv.conf`

This file tells the name resolution libraries:

- The name of the domain to which the machine belongs.
- The name(s) of any domains that should be automatically searched when trying to resolve unqualified host names to their IP address.
- The name or IP address of available Domain Name Servers that may be asked to perform name-to-address translation lookups.

26.3.3 `/etc/host.conf`

`/etc/host.conf` is the primary means by which the setting in `/etc/resolv.conf` may be effected. It is a critical configuration file. This file controls the order by which name resolution may proceed. The typical structure is:

```
order hosts,bind
multi on
```

then both addresses should be returned. Please refer to the man page for `host.conf` for further details.

26.3.4 `/etc/nsswitch.conf`

This file controls the actual name resolution targets. The file typically has resolver object specifications as follows:

```
# /etc/nsswitch.conf
#
# Name Service Switch configuration file.
#

passwd:      compat
# Alternative entries for password authentication are:
# passwd:    compat files nis ldap winbind
shadow:      compat
group:       compat

hosts:       files nis dns
# Alternative entries for host name resolution are:
# hosts:     files dns nis nis+ hesiod db compat ldap wins
networks:    nis files dns

ethers:      nis files
protocols:   nis files
rpc:         nis files
services:    nis files
```

Of course, each of these mechanisms requires that the appropriate facilities and/or services are correctly configured.

It should be noted that unless a network request/message must be sent, TCP/IP networks are silent. All TCP/IP communications assume a principal of speaking only when necessary.

Starting with version 2.2.0, Samba has Linux support for extensions to the name service switch infrastructure so Linux clients will be able to obtain resolution of MS Windows NetBIOS names to IP Addresses. To gain this functionality, Samba needs to be compiled with appropriate arguments to the make command (i.e., `make nsswitch/libnss_wins.so`). The resulting library should then be installed in the `/lib` directory and the `wins` parameter needs to be added to the “`hosts:`” line in the `/etc/nsswitch.conf` file. At this point, it will be possible to ping any MS Windows machine by its NetBIOS machine name, as long as that machine is within the workgroup to which both the Samba machine and the MS Windows machine belong.

26.4 Name Resolution as Used within MS Windows Networking

MS Windows networking is predicated about the name each machine is given. This name is known variously (and inconsistently) as the “*computer name*,” “*machine name*,” “*net-working name*,” “*netbios name*,” or “*SMB name*.” All terms mean the same thing with the exception of “*netbios name*” that can also apply to the name of the workgroup or the domain name. The terms “*workgroup*” and “*domain*” are really just a simple name with which the machine is associated. All NetBIOS names are exactly 16 characters in length. The 16th character is reserved. It is used to store a one-byte value that indicates service level information for the NetBIOS name that is registered. A NetBIOS machine name is, therefore, registered for each service type that is provided by the client/server.

Unique NetBIOS Names and Group Names tables list typical NetBIOS name/service type registrations.

Table 26.1. Unique NetBIOS Names

MACHINENAME<00>	Server Service is running on MACHINENAME
MACHINENAME<03>	Generic Machine Name (NetBIOS name)
MACHINENAME<20>	LanMan Server service is running on MACHINENAME
WORKGROUP<1b>	Domain Master Browser

Table 26.2. Group Names

WORKGROUP<03>	Generic Name registered by all members of WORKGROUP
WORKGROUP<1c>	Domain Controllers / Netlogon Servers
WORKGROUP<1d>	Local Master Browsers
WORKGROUP<1e>	Browser Election Service

It should be noted that all NetBIOS machines register their own names as per the above. This is in vast contrast to TCP/IP installations where traditionally the system administrator will determine in the `/etc/hosts` or in the DNS database what names are associated with each IP address.

One further point of clarification should be noted. The `/etc/hosts` file and the DNS records do not provide the NetBIOS name type information that MS Windows clients depend on to locate the type of service that may be needed. An example of this is what happens when an MS Windows client wants to locate a domain logon server. It finds this service and the IP address of a server that provides it by performing a lookup (via a NetBIOS broadcast) for enumeration of all machines that have registered the name type `*<1c>`. A logon request is then sent to each IP address that is returned in the enumerated list of IP addresses. Whichever machine first replies, it then ends up providing the logon services.

The name “*workgroup*” or “*domain*” really can be confusing since these have the added significance of indicating what is the security architecture of the MS Windows network. The term “*workgroup*” indicates that the primary nature of the network environment is that of a peer-to-peer design. In a WORKGROUP, all machines are responsible for their own security, and generally such security is limited to the use of just a password (known as Share Level security). In most situations with peer-to-peer networking, the users who

control their own machines will simply opt to have no security at all. It is possible to have User Level Security in a WORKGROUP environment, thus requiring the use of a user name and a matching password.

MS Windows networking is thus predetermined to use machine names for all local and remote machine message passing. The protocol used is called Server Message Block (SMB) and this is implemented using the NetBIOS protocol (Network Basic Input Output System). NetBIOS can be encapsulated using LLC (Logical Link Control) protocol — in which case the resulting protocol is called NetBEUI (Network Basic Extended User Interface). NetBIOS can also be run over IPX (Inter-networking Packet Exchange) protocol as used by Novell NetWare, and it can be run over TCP/IP protocols — in which case the resulting protocol is called NBT or NetBT, the NetBIOS over TCP/IP.

MS Windows machines use a complex array of name resolution mechanisms. Since we are primarily concerned with TCP/IP, this demonstration is limited to this area.

26.4.1 The NetBIOS Name Cache

All MS Windows machines employ an in-memory buffer in which is stored the NetBIOS names and IP addresses for all external machines that machine has communicated with over the past 10-15 minutes. It is more efficient to obtain an IP address for a machine from the local cache than it is to go through all the configured name resolution mechanisms.

If a machine whose name is in the local name cache has been shut down before the name had been expired and flushed from the cache, then an attempt to exchange a message with that machine will be subject to time-out delays. Its name is in the cache, so a name resolution lookup will succeed, but the machine cannot respond. This can be frustrating for users but is a characteristic of the protocol.

The MS Windows utility that allows examination of the NetBIOS name cache is called “*nbtstat*”. The Samba equivalent of this is called **nmblookup**.

26.4.2 The LMHOSTS File

This file is usually located in MS Windows NT 4.0 or Windows 200x/XP in the directory C:\WINNT\SYSTEM32\DRIVERS\ETC and contains the IP Address and the machine name in matched pairs. The LMHOSTS file performs NetBIOS name to IP address mapping.

It typically looks like this:

```
# Copyright (c) 1998 Microsoft Corp.
#
# This is a sample LMHOSTS file used by the Microsoft Wins Client (NetBIOS
# over TCP/IP) stack for Windows98
#
# This file contains the mappings of IP addresses to NT computer names
# (NetBIOS) names. Each entry should be kept on an individual line.
# The IP address should be placed in the first column followed by the
# corresponding computer name. The address and the computer name
```

```
# should be separated by at least one space or tab. The "#" character
# is generally used to denote the start of a comment (see the exceptions
# below).
#
# This file is compatible with Microsoft LAN Manager 2.x TCP/IP lmhosts
# files and offers the following extensions:
#
#     #PRE
#     #DOM:<domain>
#     #INCLUDE <filename>
#     #BEGIN_ALTERNATE
#     #END_ALTERNATE
#     \Oxnn (non-printing character support)
#
# Following any entry in the file with the characters "#PRE" will cause
# the entry to be pre-loaded into the name cache. By default, entries are
# not pre-loaded, but are parsed only after dynamic name resolution fails.
#
# Following an entry with the "#DOM:<domain>" tag will associate the
# entry with the domain specified by <domain>. This effects how the
# browser and logon services behave in TCP/IP environments. To preload
# the host name associated with #DOM entry, it is necessary to also add a
# #PRE to the line. The <domain> is always pre-loaded although it will not
# be shown when the name cache is viewed.
#
# Specifying "#INCLUDE <filename>" will force the RFC NetBIOS (NBT)
# software to seek the specified <filename> and parse it as if it were
# local. <filename> is generally a UNC-based name, allowing a
# centralized lmhosts file to be maintained on a server.
# It is ALWAYS necessary to provide a mapping for the IP address of the
# server prior to the #INCLUDE. This mapping must use the #PRE directive.
# In addition the share "public" in the example below must be in the
# LanMan Server list of "NullSessionShares" in order for client machines to
# be able to read the lmhosts file successfully. This key is under
# \machine\system\currentcontrolset\services\lanmanserver\
# parameters>nullsessionshares
# in the registry. Simply add "public" to the list found there.
#
# The #BEGIN_ and #END_ALTERNATE keywords allow multiple #INCLUDE
# statements to be grouped together. Any single successful include
# will cause the group to succeed.
#
# Finally, non-printing characters can be embedded in mappings by
# first surrounding the NetBIOS name in quotations, then using the
# \Oxnn notation to specify a hex value for a non-printing character.
#
# The following example illustrates all of these extensions:
#
```

```

# 102.54.94.97      rhino      #PRE #DOM:networking #net group's DC
# 102.54.94.102    "appname  \0x14"      #special app server
# 102.54.94.123    popular   #PRE      #source server
# 102.54.94.117    localsrv  #PRE      #needed for the include
#
# #BEGIN_ALTERNATE
# #INCLUDE \\localsrv\public\lmhosts
# #INCLUDE \\rhino\public\lmhosts
# #END_ALTERNATE
#
# In the above example, the "appname" server contains a special
# character in its name, the "popular" and "localsrv" server names are
# pre-loaded, and the "rhino" server name is specified so it can be used
# to later #INCLUDE a centrally maintained lmhosts file if the "localsrv"
# system is unavailable.
#
# Note that the whole file is parsed including comments on each lookup,
# so keeping the number of comments to a minimum will improve performance.
# Therefore it is not advisable to simply add lmhosts file entries onto the
# end of this file.

```

26.4.3 HOSTS File

This file is usually located in MS Windows NT 4.0 or Windows 200x/XP in the directory C:\WINNT\SYSTEM32\DRIVERS\ETC and contains the IP Address and the IP hostname in matched pairs. It can be used by the name resolution infrastructure in MS Windows, depending on how the TCP/IP environment is configured. This file is in every way the equivalent of the UNIX/Linux /etc/hosts file.

26.4.4 DNS Lookup

This capability is configured in the TCP/IP setup area in the network configuration facility. If enabled, an elaborate name resolution sequence is followed, the precise nature of which is dependant on how the NetBIOS Node Type parameter is configured. A Node Type of 0 means that NetBIOS broadcast (over UDP broadcast) is used if the name that is the subject of a name lookup is not found in the NetBIOS name cache. If that fails then DNS, HOSTS and LMHOSTS are checked. If set to Node Type 8, then a NetBIOS Unicast (over UDP Unicast) is sent to the WINS Server to obtain a lookup before DNS, HOSTS, LMHOSTS, or broadcast lookup is used.

26.4.5 WINS Lookup

A WINS (Windows Internet Name Server) service is the equivalent of the rfc1001/1002 specified NBNS (NetBIOS Name Server). A WINS server stores the names and IP addresses that are registered by a Windows client if the TCP/IP setup has been given at least one WINS Server IP Address.

To configure Samba to be a WINS server, the following parameter needs to be added to the `smb.conf` file:

```
wins support = Yes
```

To configure Samba to use a WINS server, the following parameters are needed in the `smb.conf` file:

```
wins support = No  
wins server = xxx.xxx.xxx.xxx
```

where `xxx.xxx.xxx.xxx` is the IP address of the WINS server.

For information about setting up Samba as a WINS server, read [Network Browsing](#).

26.5 Common Errors

TCP/IP network configuration problems find every network administrator sooner or later. The cause can be anything from keyboard mishaps, forgetfulness, simple mistakes, and carelessness. Of course, no one is ever deliberately careless!

26.5.1 Pinging Works Only in One Way

“I can ping my Samba server from Windows, but I cannot ping my Windows machine from the Samba server.”

Answer: The Windows machine was at IP Address 192.168.1.2 with netmask 255.255.255.0, the Samba server (Linux) was at IP Address 192.168.1.130 with netmask 255.255.255.128. The machines were on a local network with no external connections.

Due to inconsistent netmasks, the Windows machine was on network 192.168.1.0/24, while the Samba server was on network 192.168.1.128/25 — logically a different network.

26.5.2 Very Slow Network Connections

A common cause of slow network response includes:

- Client is configured to use DNS and the DNS server is down.
- Client is configured to use remote DNS server, but the remote connection is down.
- Client is configured to use a WINS server, but there is no WINS server.
- Client is not configured to use a WINS server, but there is a WINS server.
- Firewall is filtering our DNS or WINS traffic.

26.5.3 Samba Server Name Change Problem

“The name of the Samba server was changed, Samba was restarted, Samba server cannot be ping-ed by new name from MS Windows NT4 Workstation, but it does still respond to ping using the old name. Why?”

From this description, three things are obvious:

- WINS is not in use, only broadcast-based name resolution is used.
- The Samba server was renamed and restarted within the last 10-15 minutes.
- The old Samba server name is still in the NetBIOS name cache on the MS Windows NT4 Workstation.

To find what names are present in the NetBIOS name cache on the MS Windows NT4 machine, open a **cmd** shell and then:

```
C:\> nbtstat -n
```

NetBIOS Local Name Table

Name		Type	Status
FRODO	<03>	UNIQUE	Registered
ADMINISTRATOR	<03>	UNIQUE	Registered
FRODO	<00>	UNIQUE	Registered
SARDON	<00>	GROUP	Registered
FRODO	<20>	UNIQUE	Registered
FRODO	<1F>	UNIQUE	Registered

```
C:\> nbtstat -c
```

NetBIOS Remote Cache Name Table

Name		Type	Host Address	Life [sec]
GANDALF	<20>	UNIQUE	192.168.1.1	240

```
C:\>
```

In the above example, GANDALF is the Samba server and FRODO is the MS Windows NT4 Workstation. The first listing shows the contents of the Local Name Table (i.e., Identity information on the MS Windows workstation) and the second shows the NetBIOS name in the NetBIOS name cache. The name cache contains the remote machines known to this workstation.

UNICODE/CHARSETS

27.1 Features and Benefits

Every industry eventually matures. One of the great areas of maturation is in the focus that has been given over the past decade to make it possible for anyone anywhere to use a computer. It has not always been that way, in fact, not so long ago it was common for software to be written for exclusive use in the country of origin.

Of all the effort that has been brought to bear on providing native language support for all computer users, the efforts of the Openi18n organization <<http://www.openi18n.org/>> is deserving of special mention.

Samba-2.x supported a single locale through a mechanism called *codepages*. Samba-3 is destined to become a truly trans-global file and printer-sharing platform.

27.2 What Are Charsets and Unicode?

Computers communicate in numbers. In texts, each number will be translated to a corresponding letter. The meaning that will be assigned to a certain number depends on the *character set (charset)* that is used.

A charset can be seen as a table that is used to translate numbers to letters. Not all computers use the same charset (there are charsets with German umlauts, Japanese characters, and so on). The American Standard Code for Information Interchange (ASCII) encoding system has been the normative character encoding scheme used by computers to date. This employs a charset that contains 256 characters. Using this mode of encoding each character takes exactly one byte.

There are also charsets that support extended characters, but those need at least twice as much storage space as does ASCII encoding. Such charsets can contain $256 * 256 = 65536$ characters, which is more than all possible characters one could think of. They are called multi-byte charsets because they use more than one byte to store one character.

One standardized multi-byte charset encoding scheme is known as unicode <<http://www.unicode.org/>>. A big advantage of using a multi-byte charset is that you only need one. There is no need to make sure two computers use the same charset when they are communicating.

Old Windows clients use single-byte charsets, named *codepages*, by Microsoft. However, there is no support for negotiating the charset to be used in the SMB/CIFS protocol. Thus, you have to make sure you are using the same charset when talking to an older client. Newer clients (Windows NT, 200x, XP) talk unicode over the wire.

27.3 Samba and Charsets

As of Samba-3, Samba can (and will) talk unicode over the wire. Internally, Samba knows of three kinds of character sets:

unix charset This is the charset used internally by your operating system. The default is UTF-8, which is fine for most systems, which covers all characters in all languages. The default in previous Samba releases was ASCII.

display charset This is the charset Samba will use to print messages on your screen. It should generally be the same as the *unix charset*.

dos charset This is the charset Samba uses when communicating with DOS and Windows 9x/Me clients. It will talk unicode to all newer clients. The default depends on the charsets you have installed on your system. Run `testparm -v | grep "dos charset"` to see what the default is on your system.

27.4 Conversion from Old Names

Because previous Samba versions did not do any charset conversion, characters in filenames are usually not correct in the UNIX charset but only for the local charset used by the DOS/Windows clients.

Bjoern Jacke has written a utility named `convmv` <<http://j3e.de/linux/convmv/>> that can convert whole directory structures to different charsets with one single command.

27.5 Japanese Charsets

Setting up Japanese charsets is quite difficult. This is mainly because:

- The Windows character set is extended from the original legacy Japanese standard (JIS X 0208) and is not standardized. This means that the strictly standardized implementation cannot support the full Windows character set.
- Mainly for historical reasons, there are several encoding methods in Japanese, which are not fully compatible with each other. There are two major encoding methods. One is the Shift_JIS series, it is used in Windows and some UNIX's. The other is the EUC-JP series, used in most UNIX's and Linux. Moreover, Samba previously also

offered several unique encoding methods, named CAP and HEX, to keep interoperability with CAP/NetAtalk and UNIX's which can't use Japanese filenames. Some implementations of the EUC-JP series can't support the full Windows character set.

- There are some code conversion tables between Unicode and legacy Japanese character sets. One is compatible with Windows, another one is based on the reference of the Unicode consortium and others are a mixed implementation. The Unicode consortium does not officially define any conversion tables between Unicode and legacy character sets so there cannot be standard one.
- The character set and conversion tables available in `iconv()` depends on the `iconv` library that is available. Next to that, the Japanese locale names may be different on different systems. This means that the value of the charset parameters depends on the implementation of `iconv()` you are using.

Though 2 byte fixed UCS-2 encoding is used in Windows internally, Shift_JIS series encoding is usually used in Japanese environments as ASCII encoding is in English environments.

27.5.1 Basic Parameter Setting

`dos charset` and `display charset` should be set to the locale compatible with the character set and encoding method used on Windows. This is usually CP932 but sometimes has a different name.

`unix charset` can be either Shift_JIS series, EUC-JP series and UTF-8. UTF-8 is always available but the availability of other locales and its name itself depends on the system.

Additionally, you can consider to use the Shift_JIS series as the value of the `unix charset` parameter by using the `vfs_cap` module, which does the same thing as setting "*coding system = CAP*" in the Samba 2.2 series.

Where to set `unix charset` to is a difficult question. Here is a list of details, advantages and disadvantages of using a certain value.

Shift_JIS series Shift_JIS series means a locale which is equivalent to Shift_JIS, used as a standard on Japanese Windows. In the case of Shift_JIS, for example if a Japanese file name consist of 0x8ba4 and 0x974c (a 4 bytes Japanese character string meaning "*share*") and "*.txt*" is written from Windows on Samba, the file name on UNIX becomes 0x8ba4, 0x974c, "*.txt*" (a 8 bytes BINARY string), same as Windows.

Since Shift_JIS series is usually used on some commercial based UNIX's; hp-ux and AIX as Japanese locale (however, it is also possible to use the EUC-JP series), To use Shift_JIS series on these platforms, Japanese file names created from Windows can be referred to also on UNIX.

If your UNIX is already working with Shift_JIS and there is a user who needs to use Japanese file names written from Windows, the Shift_JIS series is the best choice. However, broken file names may be displayed and some commands which cannot handle non-ASCII filenames may be aborted during parsing filenames. especially there

may be “\ (0x5c)” in file names, which need to be handled carefully. So you had better not touch file names written from Windows on UNIX.

Note that most Japanese free software actually works with EUC-JP only. You had better verify if the Japanese free software can work with Shift_JIS.

EUC-JP series EUC-JP series means a locale which is equivalent to the industry standard called EUC-JP, widely used in Japanese UNIX (although EUC contains specifications for languages other than Japanese, such as EUC-KR). In the case of EUC-JP series, for example if a Japanese file name consist of 0x8ba4 and 0x974c and “.txt” is written from Windows on Samba, the file name on UNIX becomes 0xb6a6, 0xcdad, “.txt” (a 8 bytes BINARY string).

Since EUC-JP is usually used on Open source UNIX, Linux and FreeBSD, and on commercial based UNIX, Solaris, IRIX and Tru64 UNIX as Japanese locale (however, it is also possible on Solaris to use Shift_JIS and UTF-8, on Tru64 UNIX to use Shift_JIS). To use EUC-JP series, most Japanese file names created from Windows can be referred to also on UNIX. Also, most Japanese free software work mainly with EUC-JP only.

It is recommended to choose EUC-JP series when using Japanese file names on these UNIX.

Although there is no character which needs to be carefully treated like “\ (0x5c)”, broken file names may be displayed and some commands which cannot handle non-ASCII filenames may be aborted during parsing filenames.

Moreover, if you built Samba using differently installed libiconv, eucJP-ms locale included in libiconv and EUC-JP series locale included in OS may not be compatible. In this case, you may need to avoid using incompatible characters for file names.

UTF-8 UTF-8 means a locale which is equivalent to UTF-8, the international standard defined by Unicode consortium. In UTF-8, a *character* is expressed using 1-3 bytes. In case of Japanese, most characters are expressed using 3 bytes. Since on Windows Shift_JIS, where a character is expressed with 1 or 2 bytes, is used to express Japanese, basically a byte length of a UTF-8 string grows 1.5 times the length of a original Shift_JIS string. In the case of UTF-8, for example if a Japanese file name consist of 0x8ba4 and 0x974c and “.txt” is written from Windows on Samba, the file name on UNIX becomes 0xe585, 0xb1e6, 0x9c89, “.txt” (a 10 bytes BINARY string).

For systems where iconv() is not available or where iconv()'s locales are not compatible with Windows, UTF-8 is the only locale available.

There are no systems that use UTF-8 as default locale for Japanese.

Some broken file names may be displayed and some commands which cannot handle non-ASCII filenames may be aborted during parsing filenames. especially there may be “\ (0x5c)” in file names, which need to be handled carefully. So you had better not touch file names written from Windows on UNIX.

In addition, although it is not directly concerned with Samba, since there is a delicate

difference between `iconv()` function, which is generally used on UNIX and the functions used on other platforms, such as Windows and Java about the conversion table between Shift_JIS and Unicode, you should be carefully to handle UTF-8.

Although Mac OS X uses UTF-8 as its encoding method for filenames, it uses an extended UTF-8 specification that Samba cannot handle so UTF-8 locale is not available for Mac OS X.

Shift_JIS series + vfs_cap (CAP encoding) CAP encoding means a specification using in CAP and NetAtalk, file server software for Macintosh. In the case of CAP encoding, for example if a Japanese file name consist of 0x8ba4 and 0x974c and “.txt” is written from Windows on Samba, the file name on UNIX becomes “:8b:a4:97L.txt” (a 14 bytes ASCII string).

For CAP encoding a byte which cannot be expressed as an ASCII character (0x80 or above) is encoded as “:xx” form. You need to take care of containing a “\ (0x5c)” in a filename but filenames are not broken in a system which cannot handle non-ASCII filenames.

The greatest merit of CAP encoding is the compatibility of encoding filenames with CAP or NetAtalk, file server software of Macintosh. Since they usually write a file name on UNIX with CAP encoding, if a directory is shared with both Samba and NetAtalk, you need to use CAP encoding to avoid non-ASCII filenames are broken.

However, recently there are some systems where NetAtalk has been patched to write filenames with EUC-JP (i.e. Japanese original Vine Linux). Here you need to choose EUC-JP series instead of CAP encoding.

`vfs_cap` itself is available for non Shift_JIS series locales for systems which cannot handle non-ASCII characters or systems which shares files with NetAtalk.

To use CAP encoding on Samba-3, you should use the `unix charset` parameter and VFS as follows:

Example 27.5.1. VFS CAP

```
[global]
    dos charset = CP932the locale name "CP932" may be different name
    unix charset = CP932
...

[cap-share]
    vfs option = cap
```

You should set CP932 if using GNU libiconv for `unix charset`. Setting this, filenames in the “`cap-share`” share are written with CAP encoding.

27.5.2 Individual Implementations

Here is some additional information regarding individual implementations:

GNU libiconv To handle Japanese correctly, you should apply the patch `libiconv-1.8-cp932-patch.diff.gz` <<http://www2d.biglobe.ne.jp/~msyk/software/libiconv-patch.html>> to `libiconv-1.8`.

Using the patched `libiconv-1.8`, these settings are available:

```
dos charset = CP932
unix charset = CP932 / eucJP-ms / UTF-8
    |          |
    |          +--- EUC-JP series
    +--- Shift_JIS series
display charset = CP932
```

Other Japanese locales (for example `Shift_JIS` and `EUC-JP`) should not be used for the lack of the compatibility with Windows.

GNU glibc To handle Japanese correctly, you should apply a patch <<http://www2d.biglobe.ne.jp/~msyk/software/glibc/>> to `glibc-2.2.5/2.3.1/2.3.2` or should use the patch-merged versions, `glibc-2.3.3` or later.

Using the above `glibc`, these setting are available:

```
dos charset = CP932
unix charset = CP932 / eucJP-ms / UTF-8
display charset = CP932
```

Other Japanese locales (for example `Shift_JIS` and `EUC-JP`) should not be used for the lack of the compatibility with Windows.

27.5.3 Migration from Samba-2.2 Series

Prior to Samba-2.2 series “*coding system*” parameter is used as `unix charset` parameter of the Samba-3 series. Next table shows the mapping table when migrating from the Samba-2.2 series to Samba-3.

27.6 Common Errors

27.6.1 CP850.so Can't Be Found

“Samba is complaining about a missing CP850.so file.”

Table 27.1. Japanese Character Sets in Samba-2.2 and Samba-3

Samba-2.2 Coding System	Samba-3 unix charset
SJIS	Shift_JIS series
EUC	EUC-JP series
EUC3 ^a	EUC-JP series
CAP	Shift_JIS series + VFS
HEX	currently none
UTF8	UTF-8
UTF8-Mac ^b	currently none
others	none

^aOnly exists in Japanese Samba version

^bOnly exists in Japanese Samba version

Answer: CP850 is the default dos charset. The dos charset is used to convert data to the codepage used by your dos clients. If you do not have any dos clients, you can safely ignore this message.

CP850 should be supported by your local iconv implementation. Make sure you have all the required packages installed. If you compiled Samba from source, make sure to configure found iconv.

BACKUP TECHNIQUES

28.1 Features and Benefits

The Samba project is over ten years old. During the early history of Samba, UNIX administrators were its key implementors. UNIX administrators will use UNIX system tools to backup UNIX system files. Over the past four years, an increasing number of Microsoft network administrators have taken an interest in Samba. This is reflected in the questions about backup in general on the Samba mailing lists.

28.2 Discussion of Backup Solutions

During discussions at a Microsoft Windows training course, one of the pro-UNIX delegates stunned the class when he pointed out that Windows NT4 is so limiting compared with UNIX. He likened UNIX to a Meccano set that has an unlimited number of tools that are simple, efficient, and, in combination, capable of achieving any desired outcome.

One of the Windows networking advocates retorted that if she wanted a Meccano set, she would buy one. She made it clear that a complex single tool that does more than is needed but does it with a clear purpose and intent is preferred by some like her.

Please note that all information here is provided as is and without recommendation of fitness or suitability. The network administrator is strongly encouraged to perform due-diligence research before implementing any backup solution, whether free software or commercial.

A useful Web site I recently stumbled across that you might like to refer to is located at www.allmerchants.com <http://www.allmerchants.com/Software/Backup_Software/>.

The following three free software projects might also merit consideration.

28.2.1 BackupPC

BackupPC version 2.0.0 has been released on SourceForge. <<http://backppc.sourceforge.net>> New features include support for **rsync/rsyncd** and internationalization of the CGI interface (including English, French, Spanish, and German).

BackupPC is a high-performance Perl-based package for backing up Linux, UNIX or Windows PCs and laptops to a server's disk. BackupPC is highly configurable and easy to

install and maintain. SMB (via smbclient), **tar** over **rsh/ssh** or **rsync/rsyncd** are used to extract client data.

Given the ever decreasing cost of disks and raid systems, it is now practical and cost effective to backup a large number of machines onto a server's local disk or network storage. This is what BackupPC does.

Key features are pooling of identical files (big savings in server disk space), compression, and a comprehensive CGI interface that allows users to browse backups and restore files.

BackupPC is free software distributed under a GNU GPL license. BackupPC runs on Linux/UNIX/freenix servers, and has been tested on Linux, UNIX, Windows 9x/ME, Windows 98, Windows 200x, Windows XP, and Mac OSX clients.

28.2.2 Rsync

rsync is a flexible program for efficiently copying files or directory trees.

rsync has many options to select which files will be copied and how they are to be transferred. It may be used as an alternative to **ftp**, **http**, **scp**, or **rcp**.

The rsync remote-update protocol allows rsync to transfer just the differences between two sets of files across the network link, using an efficient checksum-search algorithm described in the technical report that accompanies the rsync package.

Some of the additional features of rsync are:

- Support for copying links, devices, owners, groups, and permissions.
- Exclude and exclude-from options are similar to GNU tar.
- A CVS exclude mode for ignoring the same files that CVS would ignore.
- Can use any transparent remote shell, including rsh or ssh.
- Does not require root privileges.
- Pipelining of file transfers to minimize latency costs.
- Support for anonymous or authenticated rsync servers (ideal for mirroring).

28.2.3 Amanda

Amanda, the Advanced Maryland Automatic Network Disk Archiver, is a backup system that allows the administrator of a LAN to set up a single master backup server to back up multiple hosts to a single large capacity tape drive. Amanda uses native dump and/or GNU tar facilities and can back up a large number of workstations running multiple versions of UNIX. Recent versions can also use Samba to back up Microsoft Windows hosts.

For more information regarding Amanda, please check the www.amanda.org/ site. <<http://www.amanda.org/>>

28.2.4 BOBS: Browseable Online Backup System

Browseable Online Backup System (BOBS) is a complete online backup system. Uses large disks for storing backups and lets users browse the files using a Web browser. Handles some special files like AppleDouble and icon files.

The home page for BOBS is located at `bobs.sourceforge.net`. `<http://bobs.sourceforge.net/>`

HIGH AVAILABILITY

29.1 Features and Benefits

Network administrators are often concerned about the availability of file and print services. Network users are inclined toward intolerance of the services they depend on to perform vital task responsibilities.

A sign in a computer room served to remind staff of their responsibilities. It read:

All humans fail, in both great and small ways we fail continually. Machines fail too. Computers are machines that are managed by humans, the fallout from failure can be spectacular. Your responsibility is to deal with failure, to anticipate it and to eliminate it as far as is humanly and economically wise to achieve. Are your actions part of the problem or part of the solution?

If we are to deal with failure in a planned and productive manner, then first we must understand the problem. That is the purpose of this chapter.

Parenthetically, in the following discussion there are seeds of information on how to provision a network infrastructure against failure. Our purpose here is not to provide a lengthy dissertation on the subject of high availability. Additionally, we have made a conscious decision to not provide detailed working examples of high availability solutions; instead we present an overview of the issues in the hope that someone will rise to the challenge of providing a detailed document that is focused purely on presentation of the current state of knowledge and practice in high availability as it applies to the deployment of Samba and other CIFS/SMB technologies.

29.2 Technical Discussion

The following summary was part of a presentation by Jeremy Allison at the SambaXP 2003 conference that was held at Goettingen, Germany, in April 2003. Material has been added from other sources, but it was Jeremy who inspired the structure that follows.

29.2.1 The Ultimate Goal

All clustering technologies aim to achieve one or more of the following:

- Obtain the maximum affordable computational power.
- Obtain faster program execution.
- Deliver unstopable services.
- Avert points of failure.
- Exact most effective utilization of resources.

A clustered file server ideally has the following properties:

- All clients can connect transparently to any server.
- A server can fail and clients are transparently reconnected to another server.
- All servers server out the same set of files.
- All file changes are immediately seen on all servers.
 - Requires a distributed file system.
- Infinite ability to scale by adding more servers or disks.

29.2.2 Why Is This So Hard?

In short, the problem is one of *state*.

- All TCP/IP connections are dependent on state information.

The TCP connection involves a packet sequence number. This sequence number would need to be dynamically updated on all machines in the cluster to effect seamless TCP fail-over.

- CIFS/SMB (the Windows networking protocols) uses TCP connections.

This means that from a basic design perspective, fail-over is not seriously considered.

- All current SMB clusters are fail-over solutions — they rely on the clients to reconnect. They provide server fail-over, but clients can lose information due to a server failure.
- Servers keep state information about client connections.
 - CIFS/SMB involves a lot of state.
 - Every file open must be compared with other file opens to check share modes.

29.2.2.1 The Front-End Challenge

To make it possible for a cluster of file servers to appear as a single server that has one name and one IP address, the incoming TCP data streams from clients must be processed by the front end virtual server. This server must de-multiplex the incoming packets at the SMB protocol layer level and then feed the SMB packet to different servers in the cluster.

One could split all IPC\$ connections and RPC calls to one server to handle printing and user lookup requirements. RPC Printing handles are shared between different IPC4 sessions — it is hard to split this across clustered servers!

Conceptually speaking, all other servers would then provide only file services. This is a simpler problem to concentrate on.

29.2.2.2 De-multiplexing SMB Requests

De-multiplexing of SMB requests requires knowledge of SMB state information, all of which must be held by the front-end *virtual* server. This is a perplexing and complicated problem to solve.

Windows XP and later have changed semantics so state information (vuid, tid, fid) must match for a successful operation. This makes things simpler than before and is a positive step forward.

SMB requests are sent by vuid to their associated server. No code exists today to affect this solution. This problem is conceptually similar to the problem of correctly handling requests from multiple requests from Windows 2000 Terminal Server in Samba.

One possibility is to start by exposing the server pool to clients directly. This could eliminate the de-multiplexing step.

29.2.2.3 The Distributed File System Challenge

There exists many distributed file systems for UNIX and Linux.

Many could be adopted to backend our cluster, so long as awareness of SMB semantics is kept in mind (share modes, locking and oplock issues in particular). Common free distributed file systems include:

- NFS
- AFS
- OpenGFS
- Lustre

The server pool (cluster) can use any distributed file system backend if all SMB semantics are performed within this pool.

29.2.2.4 Restrictive Constraints on Distributed File Systems

Where a clustered server provides purely SMB services, oplock handling may be done within the server pool without imposing a need for this to be passed to the backend file system pool.

On the other hand, where the server pool also provides NFS or other file services, it will be essential that the implementation be oplock aware so it can interoperate with SMB services.

This is a significant challenge today. A failure to provide this will result in a significant loss of performance that will be sorely noted by users of Microsoft Windows clients.

Last, all state information must be shared across the server pool.

29.2.2.5 Server Pool Communications

Most backend file systems support POSIX file semantics. This makes it difficult to push SMB semantics back into the file system. POSIX locks have different properties and semantics from SMB locks.

All **smbd** processes in the server pool must of necessity communicate very quickly. For this, the current *tdb* file structure that Samba uses is not suitable for use across a network. Clustered **smbd**'s must use something else.

29.2.2.6 Server Pool Communications Demands

High speed inter-server communications in the server pool is a design prerequisite for a fully functional system. Possibilities for this include:

- Proprietary shared memory bus (example: Myrinet or SCI [Scalable Coherent Interface]). These are high cost items.
- Gigabit ethernet (now quite affordable).
- Raw ethernet framing (to bypass TCP and UDP overheads).

We have yet to identify metrics for performance demands to enable this to happen effectively.

29.2.2.7 Required Modifications to Samba

Samba needs to be significantly modified to work with a high-speed server inter-connect system to permit transparent fail-over clustering.

Particular functions inside Samba that will be affected include:

- The locking database, oplock notifications, and the share mode database.
- Failure semantics need to be defined. Samba behaves the same way as Windows. When oplock messages fail, a file open request is allowed, but this is potentially dangerous in a clustered environment. So how should inter-server pool failure semantics function and how should this be implemented?
- Should this be implemented using a point-to-point lock manager, or can this be done using multicast techniques?

29.2.3 A Simple Solution

Allowing fail-over servers to handle different functions within the exported file system removes the problem of requiring a distributed locking protocol.

If only one server is active in a pair, the need for high speed server interconnect is avoided. This allows the use of existing high availability solutions, instead of inventing a new one. This simpler solution comes at a price — the cost of which is the need to manage a more complex file name space. Since there is now not a single file system, administrators must remember where all services are located — a complexity not easily dealt with.

The *virtual server* is still needed to redirect requests to backend servers. Backend file space integrity is the responsibility of the administrator.

29.2.4 High Availability Server Products

Fail-over servers must communicate in order to handle resource fail-over. This is essential for high availability services. The use of a dedicated heartbeat is a common technique to introduce some intelligence into the fail-over process. This is often done over a dedicated link (LAN or serial).

Many fail-over solutions (like Red Hat Cluster Manager, as well as Microsoft Wolfpack) can use a shared SCSI or Fiber Channel disk storage array for fail-over communication. Information regarding Red Hat high availability solutions for Samba may be obtained from: [www.redhat.com](http://www.redhat.com/docs/manuals/enterprise/RHEL-AS-2.1-Manual/cluster-manager/s1-service-samba.html). <<http://www.redhat.com/docs/manuals/enterprise/RHEL-AS-2.1-Manual/cluster-manager/s1-service-samba.html>>

The Linux High Availability project is a resource worthy of consultation if your desire is to build a highly available Samba file server solution. Please consult the home page at www.linux-ha.org/. <<http://www.linux-ha.org/>>

Front-end server complexity remains a challenge for high availability as it needs to deal gracefully with backend failures, while at the same time it needs to provide continuity of service to all network clients.

29.2.5 MS-DFS: The Poor Man's Cluster

MS-DFS links can be used to redirect clients to disparate backend servers. This pushes complexity back to the network client, something already included by Microsoft. MS-DFS creates the illusion of a simple, continuous file system name space, that even works at the file level.

Above all, at the cost of complexity of management, a distributed (pseudo-cluster) can be created using existing Samba functionality.

29.2.6 Conclusions

- Transparent SMB clustering is hard to do!
- Client fail-over is the best we can do today.
- Much more work is needed before a practical and manageable high availability transparent cluster solution will be possible.
- MS-DFS can be used to create the illusion of a single transparent cluster.

Part IV

Migration and Updating

UPGRADING FROM SAMBA-2.X TO SAMBA-3.0.0

This chapter deals exclusively with the differences between Samba-3.0.0 and Samba-2.2.8a. It points out where configuration parameters have changed, and provides a simple guide for the move from 2.2.x to 3.0.0.

30.1 Quick Migration Guide

Samba-3.0.0 default behavior should be approximately the same as Samba-2.2.x. The default behavior when the new parameter `passdb backend` is not defined in the `smb.conf` file provides the same default behavior as Samba-2.2.x with `encrypt passwords = Yes`, and will use the `smbpasswd` database.

So why say that *behavior should be approximately the same as Samba-2.2.x*? Because Samba-3.0.0 can negotiate new protocols, such as support for native Unicode, that may result in differing protocol code paths being taken. The new behavior under such circumstances is not exactly the same as the old one. The good news is that the domain and machine SIDs will be preserved across the upgrade.

If the Samba-2.2.x system was using an LDAP backend, and there is no time to update the LDAP database, then make sure that `passdb backend = ldapsam_compat` is specified in the `smb.conf` file. For the rest, behavior should remain more or less the same. At a later date, when there is time to implement a new Samba-3 compatible LDAP backend, it is possible to migrate the old LDAP database to the new one through use of the `pdbedit`. See The *pdbedit* Command.

30.2 New Features in Samba-3

The major new features are:

- 1 Active Directory support. This release is able to join an ADS realm as a member server and authenticate users using LDAP/Kerberos.

- 2 Unicode support. Samba will now negotiate Unicode on the wire and internally there is a much better infrastructure for multi-byte and Unicode character sets.
- 3 New authentication system. The internal authentication system has been almost completely rewritten. Most of the changes are internal, but the new authoring system is also very configurable.
- 4 New filename mangling system. The filename mangling system has been completely rewritten. An internal database now stores mangling maps persistently.
- 5 New “*net*” command. A new “*net*” command has been added. It is somewhat similar to the “*net*” command in Windows. Eventually, we plan to replace a bunch of other utilities (such as `smbpasswd`) with subcommands in “*net*”.
- 6 Samba now negotiates NT-style status32 codes on the wire. This considerably improves error handling.
- 7 Better Windows 200x/XP printing support including publishing printer attributes in Active Directory.
- 8 New loadable RPC modules for `passdb` backends and character sets.
- 9 New default dual-daemon `winbindd` support for better performance.
- 10 Support for migrating from a Windows NT 4.0 domain to a Samba domain and maintaining user, group and domain SIDs.
- 11 Support for establishing trust relationships with Windows NT 4.0 Domain Controllers.
- 12 Initial support for a distributed Winbind architecture using an LDAP directory for storing SID to UID/GID mappings.
- 13 Major updates to the Samba documentation tree.
- 14 Full support for client and server SMB signing to ensure compatibility with default Windows 2003 security settings.

Plus lots of other improvements!

30.3 Configuration Parameter Changes

This section contains a brief listing of changes to `smb.conf` options in the 3.0.0 release. Please refer to the `smb.conf(5)` man page for complete descriptions of new or modified parameters.

30.3.1 Removed Parameters

(Ordered Alphabetically):

- `admin log`
- `alternate permissions`
- `character set`

- client codepage
- code page directory
- coding system
- domain admin group
- domain guest group
- force unknown acl user
- nt smb support
- post script
- printer driver
- printer driver file
- printer driver location
- status
- strip dot
- total print jobs
- use rhosts
- valid chars
- vfs options

30.3.2 New Parameters

(New parameters have been grouped by function):

Remote Management

- abort shutdown script
- shutdown script

User and Group Account Management:

- add group script
- add machine script
- add user to group script
- algorithmic rid base
- delete group script
- delete user from group script
- passdb backend
- set primary group script

Authentication:

- auth methods
- realm

Protocol Options:

- client lanman auth
- client NTLMv2 auth
- client schannel
- client signing
- client use spnego
- disable netbios
- ntlm auth
- paranoid server security
- server schannel
- server signing
- smb ports
- use spnego

File Service:

- get quota command
- hide special files
- hide unwriteable files
- hostname lookups
- kernel change notify
- mangle prefix
- map acl inherit
- msdfs proxy
- set quota command
- use sendfile
- vfs objects

Printing:

- max reported print jobs

Unicode and Character Sets:

- display charset

- dos charset
- unicode
- UNIX charset

SID to UID/GID Mappings:

- idmap backend
- idmap gid
- idmap uid
- winbind enable local accounts
- winbind trusted domains only
- template primary group
- enable rid algorithm

LDAP:

- ldap delete dn
- ldap group suffix
- ldap idmap suffix
- ldap machine suffix
- ldap passwd sync
- ldap user suffix

General Configuration:

- preload modules
- privatedir

30.3.3 Modified Parameters (Changes in Behavior):

- encrypt passwords (enabled by default)
- mangling method (set to hash2 by default)
- passwd chat
- passwd program
- password server
- restrict anonymous (integer value)
- security (new ads value)
- strict locking (enabled by default)
- winbind cache time (increased to 5 minutes)

- winbind uid (deprecated in favor of idmap uid)
- winbind gid (deprecated in favor of idmap gid)

30.4 New Functionality

30.4.1 Databases

This section contains brief descriptions of any new databases introduced in Samba-3. Please remember to backup your existing `lock directory`/*tdb before upgrading to Samba-3. Samba will upgrade databases as they are opened (if necessary), but downgrading from 3.0 to 2.2 is an unsupported path.

The new tdb files are described in the next table.

Table 30.1. TDB File Descriptions

Name	Description	Backup?
account_policy	User policy settings	yes
gencache	Generic caching db	no
group_mapping	Mapping table from Windows groups/SID to UNIX groups	yes
idmap	new ID map table from SIDS to UNIX UIDs/GIDs	yes
namecache	Name resolution cache entries	no
netlogon_unigrp	Cache of universal group membership obtained when operating as a member of a Windows domain	no
printing/*tdb	Cached output from 'lpq command' created on a per print service basis	no
registry	Read-only Samba registry skeleton that provides support for exporting various db tables via the winreg RPCs	no

30.4.2 Changes in Behavior

The following issues are known changes in behavior between Samba-2.2 and Samba-3 that may affect certain installations of Samba.

1. When operating as a member of a Windows domain, Samba-2.2 would map any users authenticated by the remote DC to the *“guest account”* if a uid could not be obtained via the `getpwnam()` call. Samba-3 rejects the connection as `NT_STATUS_LOGON_FAILURE`. There is no current work around to re-establish the Samba-2.2 behavior.
2. When adding machines to a Samba-2.2 controlled domain, the *“add user script”* was used to create the UNIX identity of the Machine Trust Account. Samba-3 introduces a new *“add machine script”* that must be specified for this purpose. Samba-3 will not fall back to using the *“add user script”* in the absence of an *“add machine script”*.

30.4.3 Passdb Backends and Authentication

There have been a few new changes that Samba administrators should be aware of when moving to Samba-3.

1. Encrypted passwords have been enabled by default in order to interoperate better with out-of-the-box Windows client installations. This does mean that either (a) a Samba account must be created for each user, or (b) “*encrypt passwords = no*” must be explicitly defined in `smb.conf`.
2. Inclusion of new security = ads option for integration with an Active Directory domain using the native Windows Kerberos 5 and LDAP protocols.

Samba-3 also includes the possibility of setting up chains of authentication methods (auth methods) and account storage backends (passdb backend). Please refer to the `smb.conf` man page and Account Information Databases, for details. While both parameters assume sane default values, it is likely that you will need to understand what the values actually mean in order to ensure Samba operates correctly.

Certain functions of the `smbpasswd` tool have been split between the new `smbpasswd` utility, the `net` tool and the new `pdbedit` utility. See the respective man pages for details.

30.4.4 LDAP

This section outlines the new features effecting Samba/LDAP integration.

30.4.4.1 New Schema

A new object class (`sambaSamAccount`) has been introduced to replace the old `sambaAccount`. This change aids us in the renaming of attributes to prevent clashes with attributes from other vendors. There is a conversion script (`examples/LDAP/convertSambaAccount`) to modify an LDIF file to the new schema.

Example:

```
$ ldapsearch .... -LLL -b "ou=people,dc=..." > old.ldif
$ convertSambaAccount --sid <DOM SID> --input old.ldif --output new.ldif
```

The <DOM SID> can be obtained by running

```
$ net getlocalsid <DOMAINNAME>
```

on the Samba PDC as root.

Under Samba-2.x the Domain SID can be obtained by executing:

```
$ smbpasswd -S <DOMAINNAME>
```

The old `sambaAccount` schema may still be used by specifying the `ldapsam.compat` `passdb` backend. However, the `sambaAccount` and associated attributes have been moved to the historical section of the schema file and must be uncommented before use if needed. The Samba-2.2 object class declaration for a `sambaAccount` has not changed in the Samba-3 `samba.schema` file.

Other new object classes and their uses include:

- `sambaDomain` — domain information used to allocate RIDs for users and groups as necessary. The attributes are added in “`ldap suffix`” directory entry automatically if an `idmap` UID/GID range has been set and the “`ldapsam`” `passdb` backend has been selected.
- `sambaGroupMapping` — an object representing the relationship between a `posixGroup` and a Windows group/SID. These entries are stored in the “`ldap group suffix`” and managed by the “`net groupmap`” command.
- `sambaUNIXIdPool` — created in the “`ldap idmap suffix`” entry automatically and contains the next available “`idmap UID`” and “`idmap GID`”.
- `sambaIdmapEntry` — object storing a mapping between a SID and a UNIX UID/GID. These objects are created by the `idmap_ldap` module as needed.

30.4.4.2 New Suffix for Searching

The following new `smb.conf` parameters have been added to aid in directing certain LDAP queries when `passdb backend = ldapsam://...` has been specified.

- `ldap suffix` — used to search for user and computer accounts.
- `ldap user suffix` — used to store user accounts.
- `ldap machine suffix` — used to store Machine Trust Accounts.
- `ldap group suffix` — location of `posixGroup/sambaGroupMapping` entries.
- `ldap idmap suffix` — location of `sambaIdmapEntry` objects.

If an `ldap suffix` is defined, it will be appended to all of the remaining sub-suffix parameters. In this case, the order of the suffix listings in `smb.conf` is important. Always place the `ldap suffix` first in the list.

Due to a limitation in Samba’s `smb.conf` parsing, you should not surround the DNs with quotation marks.

30.4.4.3 IdMap LDAP Support

Samba-3 supports an `ldap` backend for the `idmap` subsystem. The following options inform Samba that the `idmap` table should be stored on the directory server onterose in the “`ou=idmap,dc=quencya,dc=org`” partition.

```
[global]  
...  
    idmap backend = ldap:ldap://onterose/  
    ldap idmap suffix = ou=idmap,dc=quenya,dc=org  
    idmap uid = 40000-50000  
    idmap gid = 40000-50000
```

This configuration allows Winbind installations on multiple servers to share a UID/GID number space, thus avoiding the interoperability problems with NFS that were present in Samba-2.2.

MIGRATION FROM NT4 PDC TO SAMBA-3 PDC

This is a rough guide to assist those wishing to migrate from NT4 Domain Control to Samba-3-based Domain Control.

31.1 Planning and Getting Started

In the IT world there is often a saying that all problems are encountered because of poor planning. The corollary to this saying is that not all problems can be anticipated and planned for. Then again, good planning will anticipate most show-stopper-type situations.

Those wishing to migrate from MS Windows NT4 Domain Control to a Samba-3 Domain Control environment would do well to develop a detailed migration plan. So here are a few pointers to help migration get under way.

31.1.1 Objectives

The key objective for most organizations will be to make the migration from MS Windows NT4 to Samba-3 Domain Control as painless as possible. One of the challenges you may experience in your migration process may well be one of convincing management that the new environment should remain in place. Many who have introduced open source technologies have experienced pressure to return to a Microsoft-based platform solution at the first sign of trouble.

Before attempting a migration to a Samba-3 controlled network, make every possible effort to gain all-round commitment to the change. Know precisely *why* the change is important for the organization. Possible motivations to make a change include:

- Improve network manageability.
- Obtain better user level functionality.
- Reduce network operating costs.
- Reduce exposure caused by Microsoft withdrawal of NT4 support.

- Avoid MS License 6 implications.
- Reduce organization's dependency on Microsoft.

Make sure everyone knows that Samba-3 is not MS Windows NT4. Samba-3 offers an alternative solution that is both different from MS Windows NT4 and offers advantages compared with it. Gain recognition that Samba-3 lacks many of the features that Microsoft has promoted as core values in migration from MS Windows NT4 to MS Windows 2000 and beyond (with or without Active Directory services).

What are the features that Samba-3 cannot provide?

- Active Directory Server.
- Group Policy Objects (in Active Directory).
- Machine Policy Objects.
- Logon Scripts in Active Directory.
- Software Application and Access Controls in Active Directory.

The features that Samba-3 does provide and that may be of compelling interest to your site include:

- Lower cost of ownership.
- Global availability of support with no strings attached.
- Dynamic SMB Servers (can run more than one SMB/CIFS server per UNIX/Linux system).
- Creation of on-the-fly logon scripts.
- Creation of on-the-fly Policy Files.
- Greater stability, reliability, performance and availability.
- Manageability via an ssh connection.
- Flexible choices of back-end authentication technologies (tdbsam, ldapsam, mysqlsam).
- Ability to implement a full single-sign-on architecture.
- Ability to distribute authentication systems for absolute minimum wide area network bandwidth demand.

Before migrating a network from MS Windows NT4 to Samba-3, consider all necessary factors. Users should be educated about changes they may experience so the change will be a welcome one and not become an obstacle to the work they need to do. The following are factors that will help ensure a successful migration:

31.1.1.1 Domain Layout

Samba-3 can be configured as a Domain Controller, a back-up Domain Controller (probably best called a secondary controller), a Domain Member, or as a stand-alone Server. The

Windows network security domain context should be sized and scoped before implementation. Particular attention needs to be paid to the location of the primary Domain Controller (PDC) as well as backup controllers (BDCs). One way in which Samba-3 differs from Microsoft technology is that if one chooses to use an LDAP authentication backend, then the same database can be used by several different domains. In a complex organization, there can be a single LDAP database, which itself can be distributed (have a master server and multiple slave servers) that can simultaneously serve multiple domains.

From a design perspective, the number of users per server as well as the number of servers per domain should be scaled taking into consideration server capacity and network bandwidth.

A physical network segment may house several domains. Each may span multiple network segments. Where domains span routed network segments, consider and test the performance implications of the design and layout of a network. A centrally located Domain Controller that is designed to serve multiple routed network segments may result in severe performance problems. Check the response time (ping timing) between the remote segment and the PDC. If it's long (more than 100 ms), locate a backup controller (BDC) on the remote segment to serve as the local authentication and access control server.

31.1.1.2 Server Share and Directory Layout

There are cardinal rules to effective network design that cannot be broken with impunity. The most important rule: Simplicity is king in every well-controlled network. Every part of the infrastructure must be managed; the more complex it is, the greater will be the demand of keeping systems secure and functional.

Keep in mind the nature of how data must be shared. Physical disk space layout should be considered carefully. Some data must be backed up. The simpler the disk layout the easier it will be to keep track of backup needs. Identify what backup media will meet your needs; consider backup to tape, CD-ROM or (DVD-ROM), or other offline storage medium. Plan and implement for minimum maintenance. Leave nothing to chance in your design; above all, do not leave backups to chance: Backup, test, and validate every backup, create a disaster recovery plan and prove that it works.

Users should be grouped according to data access control needs. File and directory access is best controlled via group permissions and the use of the “*sticky bit*” on group controlled directories may substantially avoid file access complaints from Samba share users.

Inexperienced network administrators often attempt elaborate techniques to set access controls on files, directories, shares, as well as in share definitions. Keep your design and implementation simple and document your design extensively. Have others audit your documentation. Do not create a complex mess that your successor will not understand. Remember, job security through complex design and implementation may cause loss of operations and downtime to users as the new administrator learns to untangle your knots. Keep access controls simple and effective and make sure that users will never be interrupted by obtuse complexity.

31.1.1.3 Logon Scripts

Logon scripts can help to ensure that all users gain the share and printer connections they need.

Logon scripts can be created on-the-fly so all commands executed are specific to the rights and privileges granted to the user. The preferred controls should be affected through group membership so group information can be used to create a custom logon script using the `preexec` parameters to the `NETLOGON` share.

Some sites prefer to use a tool such as **kixstart** to establish a controlled user environment. In any case, you may wish to do a Google search for logon script process controls. In particular, you may wish to explore the use of the Microsoft Knowledge Base article KB189105 that deals with how to add printers without user intervention via the logon script process.

31.1.1.4 Profile Migration/Creation

User and Group Profiles may be migrated using the tools described in the section titled Desktop Profile Management.

Profiles may also be managed using the Samba-3 tool **profiles**. This tool allows the MS Windows NT-style security identifiers (SIDs) that are stored inside the profile `NTuser.DAT` file to be changed to the SID of the Samba-3 domain.

31.1.1.5 User and Group Accounts

It is possible to migrate all account settings from an MS Windows NT4 domain to Samba-3. Before attempting to migrate user and group accounts, it is **STRONGLY** advised to create in Samba-3 the groups that are present on the MS Windows NT4 domain *AND* to map them to suitable UNIX/Linux groups. By following this simple advice, all user and group attributes should migrate painlessly.

31.1.2 Steps in Migration Process

The approximate migration process is described below.

- You have an NT4 PDC that has the users, groups, policies and profiles to be migrated.
- Samba-3 set up as a DC with netlogon share, profile share, and so on. Configure the `smb.conf` file to function as a BDC, i.e., `domain master = No`.

The Account Migration Process

1. Create a BDC account in the old NT4 domain for the Samba server using NT Server Manager.
 - (a) Samba must not be running.
2. `net rpc join -S NT4PDC -w DOMNAME -U Administrator%passwd`
3. `net rpc vampire -S NT4PDC -U administrator%passwd`

4. `pdedit -L`

(a) Note — did the users migrate?

5. Now assign each of the UNIX groups to NT groups: (It may be useful to copy this text to a script called `initGroups.sh`)

```
#!/bin/bash
#### Keep this as a shell script for future re-use

# First assign well known domain global groups
net groupmap modify ntgroup="Domain Admins" unixgroup=root
net groupmap modify ntgroup="Domain Users"  unixgroup=users
net groupmap modify ntgroup="Domain Guests" unixgroup=nobody

# Now for our added domain global groups
net groupmap add ntgroup="Designers"  unixgroup=designers type=d rid=3200
net groupmap add ntgroup="Engineers"  unixgroup=engineers type=d rid=3210
net groupmap add ntgroup="QA Team"    unixgroup=qateam   type=d rid=3220
```

6. `net groupmap list`

(a) Check that all groups are recognized.

Migrate all the profiles, then migrate all policy files.

31.2 Migration Options

Sites that wish to migrate from MS Windows NT4 Domain Control to a Samba-based solution generally fit into three basic categories. Following table shows the possibilities.

Table 31.1. The Three Major Site Types

Number of Users	Description
< 50	Want simple conversion with no pain.
50 - 250	Want new features, can manage some in-house complexity.
> 250	Solution/Implementation must scale well, complex needs. Cross-departmental decision process. Local expertise in most areas.

31.2.1 Planning for Success

There are three basic choices for sites that intend to migrate from MS Windows NT4 to Samba-3:

- Simple conversion (total replacement).
- Upgraded conversion (could be one of integration).
- Complete redesign (completely new solution).

Minimize down-stream problems by:

- Taking sufficient time.
- Avoiding Panic.
- Testing all assumptions.
- Testing the full roll-out program, including workstation deployment.

Following table lists the conversion choices given the type of migration being contemplated.

Table 31.2. Nature of the Conversion Choices

Simple	Upgraded	Redesign
Make use of minimal OS specific features.	Translate NT4 features to new host OS features.	Decide:
Move all accounts from NT4 into Samba-3	Copy and improve	Authentication regime (database location and access)
Make least number of operational changes	Make progressive improvements	Desktop management methods
Take least amount of time to migrate	Minimize user impact	Better control of Desktops/Users
Live versus isolated conversion	Maximize functionality	Identify Needs for: <i>Manageability, Scalability, Security, Availability</i>
Integrate Samba-3 then migrate while users are active, then change of control (swap out)	Take advantage of lower maintenance opportunity	

31.2.2 Samba-3 Implementation Choices

Authentication Database/Backend Samba-3 can use an external authentication backend:

- Winbind (external Samba or NT4/200x server).
- External server could use Active Directory or NT4 Domain.
- Can use pam_mkhome.so to auto-create home dirs.
- Samba-3 can use a local authentication backend: *smbpasswd*, *tdbsam*, *ldap-sam*, *mysqlsam*

Access Control Points Samba permits Access Control Points to be set:

- On the share itself — using Share ACLs.

- On the file system — using UNIX permissions on files and directories.
Note: Can enable Posix ACLs in file system also.
- Through Samba share parameters — not recommended except as last resort.

Policies (migrate or create new ones) Exercise great caution when affecting registry changes, use the right tool and be aware that changes made through NT4-style NTConfig.POL files can leave permanent changes.

- Using Group Policy Editor (NT4).
- Watch out for Tattoo effect.

User and Group Profiles Platform-specific so use platform tool to change from a Local to a Roaming profile. Can use new profiles tool to change SIDs (NTUser.DAT).

Logon Scripts Know how they work.

User and Group Mapping to UNIX/Linux User and Group mapping code is new. Many problems have been experienced as network administrators who are familiar with Samba-2.2.x migrate to Samba-3. Carefully study the chapters that document the new password backend behavior and the new group mapping functionality.

- The *username map* facility may be needed.
- Use **net groupmap** to connect NT4 groups to UNIX groups.
- Use **pdbedit** to set/change user configuration.

When migrating to LDAP backend, it may be easier to dump the initial LDAP database to LDIF, edit, then reload into LDAP.

OS Specific Scripts/Programs may be Needed Every operating system has its peculiarities. These are the result of engineering decisions that were based on the experience of the designer, and may have side-effects that were not anticipated. Limitations that may bite the Windows network administrator include:

- Add/Delete Users: Note OS limits on size of name (Linux 8 chars) NT4 up to 254 chars.
- Add/Delete Machines: Applied only to Domain Members (Note: machine names may be limited to 16 characters).
- Use **net groupmap** to connect NT4 groups to UNIX groups.
- Add/Delete Groups: Note OS limits on size and nature. Linux limit is 16 char, no spaces and no upper case chars (**groupadd**).

Migration Tools Domain Control (NT4 Style) Profiles, Policies, Access Controls, Security

- Samba: **net**, **rpcclient**, **smbpasswd**, **pdbedit**, **profiles**.
- Windows: **NT4 Domain User Manager**, **Server Manager (NEXUS)**

SWAT — THE SAMBA WEB ADMINISTRATION TOOL

There are many and varied opinions regarding the usefulness of SWAT. No matter how hard one tries to produce the perfect configuration tool, it remains an object of personal taste. SWAT is a tool that will allow Web-based configuration of Samba. It has a wizard that may help to get Samba configured quickly, it has context-sensitive help on each `smb.conf` parameter, it provides for monitoring of current state of connection information, and it allows network-wide MS Windows network password management.

32.1 Features and Benefits

SWAT is a facility that is part of the Samba suite. The main executable is called `swat` and is invoked by the inter-networking super daemon. See appropriate section for details.

SWAT uses integral samba components to locate parameters supported by the particular version of Samba. Unlike tools and utilities that are external to Samba, SWAT is always up to date as known Samba parameters change. SWAT provides context-sensitive help for each configuration parameter, directly from `man` page entries.

There are network administrators who believe that it is a good idea to write systems documentation inside configuration files, and for them SWAT will always be a nasty tool. SWAT does not store the configuration file in any intermediate form, rather, it stores only the parameter settings, so when SWAT writes the `smb.conf` file to disk, it will write only those parameters that are at other than the default settings. The result is that all comments, as well as parameters that are no longer supported, will be lost from the `smb.conf` file. Additionally, the parameters will be written back in internal ordering.

NOTE



Before using SWAT, please be warned — SWAT will completely replace your `smb.conf` with a fully-optimized file that has been stripped of all comments you might have placed there and only non-default settings will be written to the file.

32.2 Guidelines and Technical Tips

This section aims to unlock the dark secrets behind how SWAT may be made to work, may be made more secure, and how to solve Internationalization support problems.

32.2.1 Validate SWAT Installation

The very first step that should be taken before attempting to configure a host system for SWAT operation is to check that it is installed. This may seem a trivial point to some, however several Linux distributions do not install SWAT by default, even though they do ship an install-able binary support package containing SWAT on the distribution media.

When you have confirmed that SWAT is installed it is necessary to validate that the installation includes the binary `swat` file as well as all the supporting text and Web files. A number of operating system distributions in the past have failed to include the necessary support files, even though the `swat` binary executable file was installed.

Finally, when you are sure that SWAT has been fully installed, please check the SWAT has been enabled in the control file for the inter-networking super-daemon (`inetd` or `xinetd`) that is used on your operating system platform.

32.2.1.1 Locating the `swat` File

To validate that SWAT is installed, first locate the `swat` binary file on the system. It may be found under the following directories:

- `/usr/local/samba/bin` — the default Samba location.
- `/usr/sbin` — the default location on most Linux systems.
- `/opt/samba/bin`

The actual location is much dependant on the choice of the operating system vendor, or as determined by the administrator who compiled and installed Samba.

There are a number methods that may be used to locate the `swat` binary file. The following methods may be helpful:

If `swat` is in your current operating system search path it will be easy to find it. You can ask what are the command-line options for `swat` as shown here:

```
frodo:~ # swat -?
Usage: swat [OPTION...]
```

```

-a, --disable-authentication      Disable authentication (demo mode)

Help options:
-?, --help                        Show this help message
--usage                           Display brief usage message

Common samba options:
-d, --debuglevel=DEBUGLEVEL      Set debug level
-s, --configfile=CONFIGFILE      Use alternative configuration file
-l, --log-basename=LOGFILEBASE    Basename for log/debug files
-V, --version                      Print version

```

32.2.1.2 Locating the SWAT Support Files

Now that you have found that **swat** is in the search path, it is easy to identify where the file is located. Here is another simple way this may be done:

```

frodo:~ # whereis swat
swat: /usr/sbin/swat /usr/share/man/man8/swat.8.gz

```

If the above measures fail to locate the **swat** binary, another approach is needed. The following may be used:

```

frodo:/ # find / -name swat -print
/etc/xinetd.d/swat
/usr/sbin/swat
/usr/share/samba/swat
frodo:/ #

```

This list shows that there is a control file for **xinetd**, the internet network super-daemon that is installed on this server. The location of the SWAT binary file is **/usr/sbin/swat**, and the support files for it are located under the directory **/usr/share/samba/swat**.

We must now check where **swat** expects to find its support files. This can be done as follows:

```

frodo:/ # strings /usr/sbin/swat | grep "/swat"
/swat/
...
/usr/share/samba/swat
frodo:/ #

```

The **/usr/share/samba/swat/** entry shown in this listing is the location of the support files. You should verify that the support files exist under this directory. A sample list is as shown:

```
jht@frodo: /> find /usr/share/samba/swat -print
/usr/share/samba/swat
/usr/share/samba/swat/help
/usr/share/samba/swat/lang
/usr/share/samba/swat/lang/ja
/usr/share/samba/swat/lang/ja/help
/usr/share/samba/swat/lang/ja/help/welcome.html
/usr/share/samba/swat/lang/ja/images
/usr/share/samba/swat/lang/ja/images/home.gif
...
/usr/share/samba/swat/lang/ja/include
/usr/share/samba/swat/lang/ja/include/header.nocss.html
...
/usr/share/samba/swat/lang/tr
/usr/share/samba/swat/lang/tr/help
/usr/share/samba/swat/lang/tr/help/welcome.html
/usr/share/samba/swat/lang/tr/images
/usr/share/samba/swat/lang/tr/images/home.gif
...
/usr/share/samba/swat/lang/tr/include
/usr/share/samba/swat/lang/tr/include/header.html
/usr/share/samba/swat/using_samba
...
/usr/share/samba/swat/images
/usr/share/samba/swat/images/home.gif
...
/usr/share/samba/swat/include
/usr/share/samba/swat/include/footer.html
/usr/share/samba/swat/include/header.html
jht@frodo: />
```

If the files needed are not available it will be necessary to obtain and install them before SWAT can be used.

32.2.2 Enabling SWAT for Use

SWAT should be installed to run via the network super-daemon. Depending on which system your UNIX/Linux system has, you will have either an **inetd**- or **xinetd**-based system.

The nature and location of the network super-daemon varies with the operating system implementation. The control file (or files) can be located in the file `/etc/inetd.conf` or in the directory `/etc/[x]inet[d].d` or similar.

The control entry for the older style file might be:

```
# swat is the Samba Web Administration Tool
```

```
swat stream tcp nowait.400 root /usr/sbin/swat swat
```

A control file for the newer style xinetd could be:

```
# default: off
# description: SWAT is the Samba Web Admin Tool. Use swat \
#             to configure your Samba server. To use SWAT, \
#             connect to port 901 with your favorite web browser.
service swat
{
    port      = 901
    socket_type = stream
    wait      = no
    only_from = localhost
    user      = root
    server    = /usr/sbin/swat
    log_on_failure += USERID
    disable   = no
}
```

In the above, the default setting for *disable* is *yes*. This means that SWAT is disabled. To enable use of SWAT, set this parameter to *no* as shown.

Both of the above examples assume that the `swat` binary has been located in the `/usr/sbin` directory. In addition to the above, SWAT will use a directory access point from which it will load its Help files as well as other control information. The default location for this on most Linux systems is in the directory `/usr/share/samba/swat`. The default location using Samba defaults will be `/usr/local/samba/swat`.

Access to SWAT will prompt for a logon. If you log onto SWAT as any non-root user, the only permission allowed is to view certain aspects of configuration as well as access to the password change facility. The buttons that will be exposed to the non-root user are: **HOME**, **STATUS**, **VIEW**, **PASSWORD**. The only page that allows change capability in this case is **PASSWORD**.

As long as you log onto SWAT as the user `root`, you should obtain full change and commit ability. The buttons that will be exposed include: **HOME**, **GLOBALS**, **SHARES**, **PRINTERS**, **WIZARD**, **STATUS**, **VIEW**, **PASSWORD**.

32.2.3 Securing SWAT through SSL

Many people have asked about how to setup SWAT with SSL to allow for secure remote administration of Samba. Here is a method that works, courtesy of Markus Krieger.

Modifications to the SWAT setup are as follows:

1. Install OpenSSL.
2. Generate certificate and private key.

```
root# /usr/bin/openssl req -new -x509 -days 365 -nodes -config \  
    /usr/share/doc/packages/stunnel/stunnel.cnf \  
    -out /etc/stunnel/stunnel.pem -keyout /etc/stunnel/stunnel.pem
```

3. Remove swat-entry from [x]inetd.
4. Start **stunnel**.

```
root# stunnel -p /etc/stunnel/stunnel.pem -d 901 \  
    -l /usr/local/samba/bin/swat swat
```

Afterward, simply connect to swat by using the URL <https://myhost:901>, accept the certificate and the SSL connection is up.

32.2.4 Enabling SWAT Internationalization Support

SWAT can be configured to display its messages to match the settings of the language configurations of your Web browser. It will be passed to SWAT in the Accept-Language header of the HTTP request.

To enable this feature:

- Install the proper **msg** files from the Samba `source/po` directory into `$LIBDIR`.
- Set your browsers language setting.

The name of msg file is same as the language ID sent by the browser. For example en means "English", ja means "Japanese", fr means "French".

If you do not like some of messages, or there are no **msg** files for your locale, you can create them simply by copying the **en.msg** files to the directory for "*your language ID.msg*" and filling in proper strings to each "*msgstr*". For example, in `it.msg`, the **msg** file for the Italian locale, just set:

```
msgid "Set Default"  
msgstr "Imposta Default"
```

and so on. If you find a mistake or create a new **msg** file, please email it to us so we will include this in the next release of Samba. The **msg** file should be encoded in UTF-8.

Note that if you enable this feature and the display charset is not matched to your browsers setting, the SWAT display may be corrupted. In a future version of Samba, SWAT will always display messages with UTF-8 encoding. You will then not need to set this `smb.conf` file parameter.

32.3 Overview and Quick Tour

SWAT is a tools that many be used to configure Samba, or just to obtain useful links to important reference materials such as the contents of this book, as well as other documents that have been found useful for solving Windows networking problems.

32.3.1 The SWAT Home Page

The SWAT title page provides access to the latest Samba documentation. The manual page for each Samba component is accessible from this page, as are the Samba HOWTO-Collection (this document) as well as the O'Reilly book “*Using Samba*.”

Administrators who wish to validate their Samba configuration may obtain useful information from the man pages for the diagnostic utilities. These are available from the SWAT home page also. One diagnostic tool that is not mentioned on this page, but that is particularly useful is **ethereal**. <<http://www.ethereal.com/>>

WARNING

SWAT can be configured to run in *demo* mode. This is not recommended as it runs SWAT without authentication and with full administrative ability. Allows changes to `smb.conf` as well as general operation with root privileges. The option that creates this ability is the `-a` flag to `swat`. *Do not use this in a production environment.*

32.3.2 Global Settings

The **GLOBALS** button will expose a page that allows configuration of the global parameters in `smb.conf`. There are two levels of exposure of the parameters:

- **Basic** — exposes common configuration options.
- **Advanced** — exposes configuration options needed in more complex environments.

To switch to other than **Basic** editing ability, click on **Advanced**. You may also do this by clicking on the radio button, then click on the **Commit Changes** button.

After making any changes to configuration parameters, make sure that you click on the **Commit Changes** button before moving to another area, otherwise your changes will be lost.

NOTE

SWAT has context-sensitive help. To find out what each parameter is for, simply click on the **Help** link to the left of the configuration parameter.

32.3.3 Share Settings

To effect a currently configured share, simply click on the pull down button between the **Choose Share** and the **Delete Share** buttons, select the share you wish to operate on, then to edit the settings click on the **Choose Share** button. To delete the share, simply press the **Delete Share** button.

To create a new share, next to the button labeled **Create Share** enter into the text field the name of the share to be created, then click on the **Create Share** button.

32.3.4 Printers Settings

To affect a currently configured printer, simply click on the pull down button between the **Choose Printer** and the **Delete Printer** buttons, select the printer you wish to operate on, then to edit the settings click on the **Choose Printer** button. To delete the share, simply press the **Delete Printer** button.

To create a new printer, next to the button labeled **Create Printer** enter into the text field the name of the share to be created, then click on the **Create Printer** button.

32.3.5 The SWAT Wizard

The purpose of the SWAT Wizard is to help the Microsoft-knowledgeable network administrator to configure Samba with a minimum of effort.

The Wizard page provides a tool for rewriting the `smb.conf` file in fully optimized format. This will also happen if you press the **Commit** button. The two differ since the **Rewrite** button ignores any changes that may have been made, while the **Commit** button causes all changes to be affected.

The **Edit** button permits the editing (setting) of the minimal set of options that may be necessary to create a working Samba server.

Finally, there are a limited set of options that will determine what type of server Samba will be configured for, whether it will be a WINS server, participate as a WINS client, or operate with no WINS support. By clicking one button, you can elect to expose (or not) user home directories.

32.3.6 The Status Page

The status page serves a limited purpose. First, it allows control of the Samba daemons. The key daemons that create the Samba server environment are: `smbd`, `nmbd`, `winbindd`.

The daemons may be controlled individually or as a total group. Additionally, you may set an automatic screen refresh timing. As MS Windows clients interact with Samba, new `smbd` processes will be continually spawned. The auto-refresh facility will allow you to track the changing conditions with minimal effort.

Lastly, the Status page may be used to terminate specific `smbd` client connections in order to free files that may be locked.

32.3.7 The View Page

This page allows the administrator to view the optimized `smb.conf` file and, if you are particularly masochistic, will permit you also to see all possible global configuration parameters and their settings.

32.3.8 The Password Change Page

The Password Change page is a popular tool that allows the creation, deletion, deactivation, and reactivation of MS Windows networking users on the local machine. Alternately, you can use this tool to change a local password for a user account.

When logged in as a non-root account, the user will have to provide the old password as well as the new password (twice). When logged in as *root*, only the new password is required.

One popular use for this tool is to change user passwords across a range of remote MS Windows servers.

Part V

Troubleshooting

THE SAMBA CHECKLIST

33.1 Introduction

This file contains a list of tests you can perform to validate your Samba server. It also tells you what the likely cause of the problem is if it fails any one of these steps. If it passes all these tests, then it is probably working fine.

You should do all the tests, in the order shown. We have tried to carefully choose them so later tests only use capabilities verified in the earlier tests. However, do not stop at the first error as there have been some instances when continuing with the tests has helped to solve a problem.

If you send one of the Samba mailing lists an email saying, “*it does not work*” and you have not followed this test procedure, you should not be surprised if your email is ignored.

33.2 Assumptions

In all of the tests, it is assumed you have a Samba server called BIGSERVER and a PC called ACLIENT both in workgroup TESTGROUP.

The procedure is similar for other types of clients.

It is also assumed you know the name of an available share in your `smb.conf`. I will assume this share is called `tmp`. You can add a `tmp` share like this by adding the lines shown in the next example.

Example 33.2.1. `smb.conf` with `[tmp]` share

```
[tmp]
comment = temporary files
path = /tmp
read only = yes
```

NOTE



These tests assume version 3.0.0 or later of the Samba suite. Some commands shown did not exist in earlier versions.

Please pay attention to the error messages you receive. If any error message reports that your server is being unfriendly, you should first check that your IP name resolution is correctly set up. Make sure your `/etc/resolv.conf` file points to name servers that really do exist.

Also, if you do not have DNS server access for name resolution, please check that the settings for your `smb.conf` file results in `dns proxy = no`. The best way to check this is with `testparm smb.conf`.

It is helpful to monitor the log files during testing by using the `tail -F log_file_name` in a separate terminal console (use ctrl-alt-F1 through F6 or multiple terminals in X). Relevant log files can be found (for default installations) in `/usr/local/samba/var`. Also, connection logs from machines can be found here or possibly in `/var/log/samba`, depending on how or if you specified logging in your `smb.conf` file.

If you make changes to your `smb.conf` file while going through these test, remember to restart `smbd` and `nmbd`.

33.3 The Tests

Diagnosing your Samba server

1. In the directory in which you store your `smb.conf` file, run the command `testparm smb.conf`. If it reports any errors, then your `smb.conf` configuration file is faulty.

NOTE



Your `smb.conf` file may be located in: `/etc/samba` or in `/usr/local/samba/lib`.

2. Run the command `ping BIGSERVER` from the PC and `ping ACLIENT` from the UNIX box. If you do not get a valid response, then your TCP/IP software is not correctly installed. You will need to start a “*dos prompt*” window on the PC to run ping. If you get a message saying “*host not found*” or similar, then your DNS software or `/etc/hosts` file is not correctly setup. It is possible to run Samba without DNS entries for the server and client, but it is assumed you do have correct entries for the remainder of these tests. Another reason why ping might fail is if your host is running firewall software. You will need to relax the rules to let in the workstation in question, perhaps by allowing access from another subnet (on Linux this is done via the appropriate firewall maintenance commands `ipchains` or `iptables`).

NOTE



Modern Linux distributions install `ipchains`/`iptables` by default. This is a common problem that is often overlooked.

If you wish to check what firewall rules may be present in a system under test, simply run `iptables -L -v` or if `ipchains`-based firewall rules are in use, `ipchains -L -v`. Here is a sample listing from a system that has an external ethernet interface (`eth1`) on which Samba is not active, and an internal (private network) interface (`eth0`) on which Samba is active:

```
frodo:~ # iptables -L -v
Chain INPUT (policy DROP 98496 packets, 12M bytes)
  pkts bytes target    prot opt in     out     source destination
  187K 109M ACCEPT    all  --  lo     any     anywhere anywhere
  892K 125M ACCEPT    all  --  eth0   any     anywhere anywhere
 1399K 1380M ACCEPT    all  --  eth1   any     anywhere anywhere \
                                state RELATED,ESTABLISHED

Chain FORWARD (policy DROP 0 packets, 0 bytes)
  pkts bytes target    prot opt in     out     source destination
  978K 1177M ACCEPT    all  --  eth1   eth0    anywhere anywhere \
                                state RELATED,ESTABLISHED
  658K   40M ACCEPT    all  --  eth0   eth1    anywhere anywhere
    0     0 LOG        all  --  any    any     anywhere anywhere \
                                LOG level warning

Chain OUTPUT (policy ACCEPT 2875K packets, 1508M bytes)
  pkts bytes target    prot opt in     out     source destination

Chain reject_func (0 references)
  pkts bytes target    prot opt in     out     source destination
```

- Run the command: `smbclient -L BIGSERVER` on the UNIX box. You should get back a list of available shares. If you get an error message containing the string “*Bad password*”, then you probably have either an incorrect `hosts allow`, `hosts deny` or `valid users` line in your `smb.conf`, or your guest account is not valid. Check what your guest account is using `testparm` and temporarily remove any `hosts allow`, `hosts deny`, `valid users` or `invalid users` lines. If you get a message “*connection refused*” response, then the `smbd` server may not be running. If you installed it in `inetd.conf`, then you probably edited that file incorrectly. If you installed it as a daemon, then check that it is running, and check that the `netbios-ssn` port is in a `LISTEN` state using `netstat -a`.

NOTE



Some UNIX/Linux systems use **xinetd** in place of **inetd**. Check your system documentation for the location of the control files for your particular system implementation of the network super daemon.

If you get a message saying “*session request failed*”, the server refused the connection. If it says “*Your server software is being unfriendly*”, then it’s probably because you have invalid command line parameters to `smbd`, or a similar fatal problem with the initial startup of `smbd`. Also check your config file (`smb.conf`) for syntax errors with `testparm` and that the various directories where Samba keeps its log and lock files exist. There are a number of reasons for which `smbd` may refuse or decline a session request. The most common of these involve one or more of the `smb.conf` file entries as shown in the next example.

Example 33.3.1. Configuration for only allowing connections from a certain subnet

```
[globals]
...
    hosts deny = ALL
    hosts allow = xxx.xxx.xxx.xxx/yy
    interfaces = eth0
    bind interfaces only = Yes
...
```

In the above, no allowance has been made for any session requests that will automatically translate to the loopback adapter address 127.0.0.1. To solve this problem, change these lines as shown in the following example.

Example 33.3.2. Configuration for allowing connections from a certain subnet and localhost

```
[globals]
...
    hosts deny = ALL
    hosts allow = xxx.xxx.xxx.xxx/yy 127.
    interfaces = eth0 lo
...
```

Another common cause of these two errors is having something already running on port 139, such as Samba (`smbd` is running from `inetd` already) or something like Digital’s Pathworks. Check your `inetd.conf` file before trying to start `smbd` as a daemon — it can avoid a lot of frustration! And yet another possible cause for failure of this test is

when the subnet mask and/or broadcast address settings are incorrect. Please check that the network interface IP Address/Broadcast Address/Subnet Mask settings are correct and that Samba has correctly noted these in the `log.nmbd` file.

4. Run the command: **nmblookup -B BIGSERVER __SAMBA__**. You should get back the IP address of your Samba server. If you do not, then nmbd is incorrectly installed. Check your `inetd.conf` if you run it from there, or that the daemon is running and listening to udp port 137. One common problem is that many inetd implementations can't take many parameters on the command line. If this is the case, then create a one-line script that contains the right parameters and run that from inetd.
5. Run the command: **nmblookup -B ACLIENT *** You should get the PC's IP address back. If you do not then the client software on the PC isn't installed correctly, or isn't started, or you got the name of the PC wrong. If ACLIENT does not resolve via DNS then use the IP address of the client in the above test.
6. Run the command: **nmblookup -d 2 *** This time we are trying the same as the previous test but are trying it via a broadcast to the default broadcast address. A number of NetBIOS/TCP/IP hosts on the network should respond, although Samba may not catch all of the responses in the short time it listens. You should see the "*got a positive name query response*" messages from several hosts. If this does not give a similar result to the previous test, then nmblookup isn't correctly getting your broadcast address through its automatic mechanism. In this case you should experiment with the interfaces option in `smb.conf` to manually configure your IP address, broadcast and netmask. If your PC and server aren't on the same subnet, then you will need to use the `-B` option to set the broadcast address to that of the PC's subnet. This test will probably fail if your subnet mask and broadcast address are not correct. (Refer to TEST 3 notes above).
7. Run the command: **smbclient //BIGSERVER/TMP**. You should then be prompted for a password. You should use the password of the account with which you are logged into the UNIX box. If you want to test with another account, then add the `-U accountname` option to the end of the command line. For example, **smbclient //bigserver/tmp -Ujohndoe**.

NOTE



It is possible to specify the password along with the username as follows: **smbclient //bigserver/tmp -Ujohndoe%secret**.

Once you enter the password, you should get the `smb>` prompt. If you do not, then look at the error message. If it says "*invalid network name*", then the service `tmp` is not correctly setup in your `smb.conf`. If it says "*bad password*", then the likely causes are:

- (a) You have shadow passwords (or some other password system) but didn't compile in support for them in `smbd`.

- (b) Your valid users configuration is incorrect.
- (c) You have a mixed case password and you haven't enabled the password level option at a high enough level.
- (d) The path line in `smb.conf` is incorrect. Check it with `testparm`.
- (e) You enabled password encryption but didn't map UNIX to Samba users. Run:

smbpasswd -a username

Once connected, you should be able to use the commands **dir**, **get**, **put** and so on. Type **help command** for instructions. You should especially check that the amount of free disk space shown is correct when you type **dir**.

8. On the PC, type the command **net view \\BIGSERVER**. You will need to do this from within a dos prompt window. You should get back a list of shares available on the server. If you get a message "*network name not found*" or similar error, then netbios name resolution is not working. This is usually caused by a problem in **nmbd**. To overcome it, you could do one of the following (you only need to choose one of them):
 - (a) Fixup the nmbd installation.
 - (b) Add the IP address of BIGSERVER to the **wins server** box in the advanced TCP/IP setup on the PC.
 - (c) Enable Windows name resolution via DNS in the advanced section of the TCP/IP setup.
 - (d) Add BIGSERVER to your lmhosts file on the PC.

If you get a message "*invalid network name*" or "*bad password error*", then apply the same fixes as for the **smbclient -L** test above. In particular, make sure your **hosts allow** line is correct (see the man pages). Also, do not overlook that fact that when the workstation requests the connection to the Samba server, it will attempt to connect using the name with which you logged onto your Windows machine. You need to make sure that an account exists on your Samba server with that exact same name and password. If you get a message "*specified computer is not receiving requests*" or similar, it probably means that the host is not contact-able via TCP services. Check to see if the host is running TCP wrappers, and if so add an entry in the `hosts.allow` file for your client (or subnet, and so on.)

9. Run the command **net use x: \\BIGSERVER\TMP**. You should be prompted for a password, then you should get a **command completed successfully** message. If not, then your PC software is incorrectly installed or your `smb.conf` is incorrect. Make sure your `hosts allow` and other config lines in `smb.conf` are correct. It's also possible that the server can't work out what user name to connect you as. To see if this is the problem, add the line `user = username` to the `[tmp]` section of `smb.conf` where `username` is the username corresponding to the password you typed. If you find this fixes things, you may need the username mapping option. It might also be the case that your client only sends encrypted passwords and you have `encrypt passwords = no` in `smb.conf`. Change this to "yes" to fix this.
10. Run the command **nmblookup -M testgroup** where `testgroup` is the name of the workgroup that your Samba server and Windows PCs belong to. You should get back

the IP address of the master browser for that workgroup. If you do not, then the election process has failed. Wait a minute to see if it is just being slow, then try again. If it still fails after that, then look at the browsing options you have set in `smb.conf`. Make sure you have `preferred master = yes` to ensure that an election is held at startup.

11. >From file manager, try to browse the server. Your Samba server should appear in the browse list of your local workgroup (or the one you specified in `smb.conf`). You should be able to double click on the name of the server and get a list of shares. If you get the error message *“invalid password”*, you are probably running Windows NT and it is refusing to browse a server that has no encrypted password capability and is in User Level Security mode. In this case, either set `security = server` and `password server = Windows_NT_Machine` in your `smb.conf` file, or make sure `encrypt passwords` is set to *“yes”*.

ANALYZING AND SOLVING SAMBA PROBLEMS

There are many sources of information available in the form of mailing lists, RFCs and documentation. The documentation that comes with the Samba distribution contains good explanations of general SMB topics such as browsing.

34.1 Diagnostics Tools

With SMB networking, it is often not immediately clear what the cause is of a certain problem. Samba itself provides rather useful information, but in some cases you might have to fall back to using a *sniffer*. A sniffer is a program that listens on your LAN, analyzes the data sent on it and displays it on the screen.

34.1.1 Debugging with Samba Itself

One of the best diagnostic tools for debugging problems is Samba itself. You can use the `-d` option for both `smbd` and `nmbd` to specify the debug level at which to run. See the man pages for `smbd`, `nmbd` and `smb.conf` for more information regarding debugging options. The debug level can range from 1 (the default) to 10 (100 for debugging passwords).

Another helpful method of debugging is to compile Samba using the `gcc -g` flag. This will include debug information in the binaries and allow you to attach `gdb` to the running `smbd/nmbd` process. To attach `gdb` to an `smbd` process for an NT workstation, first get the workstation to make the connection. Pressing `ctrl-alt-delete` and going down to the domain box is sufficient (at least, the first time you join the domain) to generate a `LsaEnumTrustedDomains`. Thereafter, the workstation maintains an open connection and there will be an `smbd` process running (assuming that you haven't set a really short `smbd` idle timeout). So, in between pressing `ctrl-alt-delete` and actually typing in your password, you can attach `gdb` and continue.

Some useful Samba commands worth investigating are:

```
$ testparm | more
```

```
$ smbclient -L //{netbios name of server}
```

34.1.2 Tcpcap

Tcpcap <<http://www.tcpcap.org/>> was the first UNIX sniffer with SMB support. It is a command-line utility and now, its SMB support is somewhat lagging that of **ethereal** and **tethereal**.

34.1.3 Ethereal

Ethereal <<http://www.ethereal.com/>> is a graphical sniffer, available for both UNIX (Gtk) and Windows. Ethereal's SMB support is quite good.

For details on the use of **ethereal**, read the well-written Ethereal User Guide.

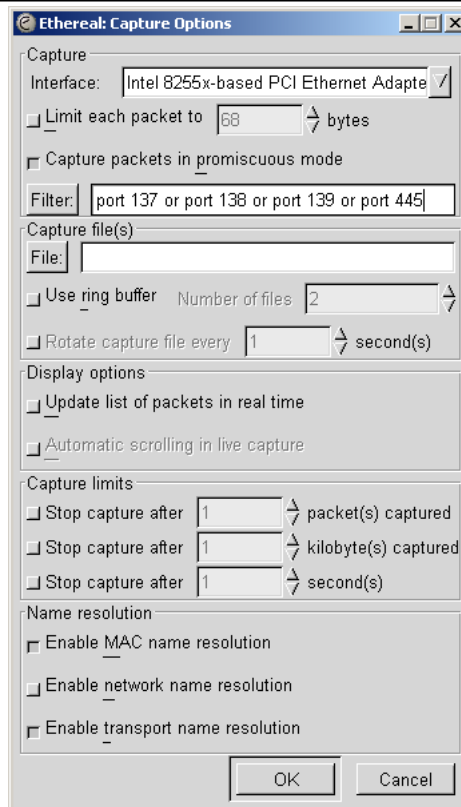

Figure 34.1. Starting a capture.

Listen for data on ports 137, 138, 139, and 445. For example, use the filter `port 137, port 138, port 139, or port 445` as seen in Starting a capture snapshot.

A console version of ethereal is available as well and is called **tethereal**.

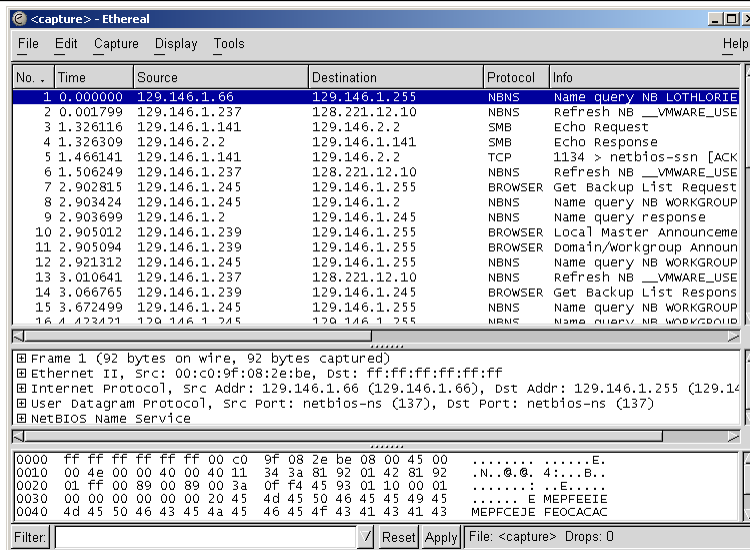

Figure 34.2. Main ethereal data window.

34.1.4 The Windows Network Monitor

For tracing things on Microsoft Windows NT, Network Monitor (aka Netmon) is available on Microsoft Developer Network CDs, the Windows NT Server install CD and the SMS CDs. The version of Netmon that ships with SMS allows for dumping packets between any two computers (i.e., placing the network interface in promiscuous mode). The version on the NT Server install CD will only allow monitoring of network traffic directed to the local NT box and broadcasts on the local subnet. Be aware that Ethereal can read and write Netmon formatted files.

34.1.4.1 Installing Network Monitor on an NT Workstation

Installing Netmon on an NT workstation requires a couple of steps. The following are instructions for installing Netmon V4.00.349, which comes with Microsoft Windows NT Server 4.0, on Microsoft Windows NT Workstation 4.0. The process should be similar for other versions of Windows NT version of Netmon. You will need both the Microsoft Windows NT Server 4.0 Install CD and the Workstation 4.0 Install CD.

Initially you will need to install Network Monitor Tools and Agent on the NT Server to do this:

- Go to **Start -> Settings -> Control Panel -> Network -> Services -> Add**.
- Select the **Network Monitor Tools and Agent** and click on **OK**.
- Click on **OK** on the Network Control Panel.
- Insert the Windows NT Server 4.0 install CD when prompted.

At this point, the Netmon files should exist in %SYSTEMROOT%\System32\netmon*.*. Two subdirectories exist as well, `parsers\` which contains the necessary DLLs for parsing the Netmon packet dump, and `captures\`.

To install the Netmon tools on an NT Workstation, you will first need to install the Network Monitor Agent from the Workstation install CD.

- Go to **Start -> Settings -> Control Panel -> Network -> Services -> Add**.
- Select the **Network Monitor Agent**, click on **OK**.
- Click on **OK** in the Network Control Panel.
- Insert the Windows NT Workstation 4.0 install CD when prompted.

Now copy the files from the NT Server in %SYSTEMROOT%\System32\netmon to %SYSTEMROOT%\System32\netmon on the Workstation and set permissions as you deem appropriate for your site. You will need administrative rights on the NT box to run Netmon.

34.1.4.2 Installing Network Monitor on Windows 9x/Me

To install Netmon on Windows 9x/Me, install the Network Monitor Agent from the Windows 9x/Me CD (\admin\nettools\netmon). There is a readme file located with the Netmon driver files on the CD if you need information on how to do this. Copy the files from a working Netmon installation.

34.2 Useful URLs

- See how Scott Merrill simulates a BDC behavior at <http://www.skippy.net/linux/smb-howto.html> <<http://www.skippy.net/linux/smb-howto.html>>.
- FTP site for older SMB specs: <ftp://ftp.microsoft.com/developr/drg/CIFS/> <<ftp://ftp.microsoft.com/developr/drg/CIFS/>>

34.3 Getting Mailing List Help

There are a number of Samba-related mailing lists. Go to <<http://samba.org>>, click on your nearest mirror and then click on **Support** and next click on **Samba-related mailing lists**.

For questions relating to Samba TNG, go to <http://www.samba-tng.org/>. <<http://www.samba-tng.org/>> It has been requested that you do not post questions about Samba-TNG to the main-stream Samba lists.

If you do post a message to one of the lists, please observe the following guidelines : ‘

- Always remember that the developers are volunteers, they are not paid and they never guarantee to produce a particular feature at a particular time. Any timelines are “*best guess*” and nothing more.

- Always mention what version of Samba you are using and what operating system it's running under. You should list the relevant sections of your `smb.conf` file, at least the options in `[global]` that affect PDC support.
- In addition to the version, if you obtained Samba via CVS, mention the date when you last checked it out.
- Try and make your questions clear and brief. Lots of long, convoluted questions get deleted before they are completely read! Do not post HTML encoded messages. Most people on mailing lists simply delete them.
- If you run one of those nifty “*I'm on holidays*” things when you are away, make sure its configured to not answer mailing list traffic. Auto-responses to mailing lists really irritate the thousands of people who end up having to deal with such bad netiquet behavior.
- Don't cross post. Work out which is the best list to post to and see what happens. Do not post to both `samba-ntdom` and `samba-technical`. Many people active on the lists subscribe to more than one list and get annoyed to see the same message two or more times. Often someone will see a message and thinking it would be better dealt with on another list, will forward it on for you.
- You might include *partial* log files written at a debug level set to as much as 20. Please do not send the entire log but just enough to give the context of the error messages.
- If you have a complete Netmon trace (from the opening of the pipe to the error), you can send the `*.CAP` file as well.
- Please think carefully before attaching a document to an email. Consider pasting the relevant parts into the body of the message. The Samba mailing lists go to a huge number of people. Do they all need a copy of your `smb.conf` in their attach directory?

34.4 How to Get Off the Mailing Lists

To have your name removed from a Samba mailing list, go to the same place where you went to subscribe to it. Go to <http://lists.samba.org> <<http://lists.samba.org/>>, click on your nearest mirror, click on **Support** and then click on **Samba related mailing lists**.

Please do not post messages to the list asking to be removed. You will only be referred to the above address (unless that process failed in some way).

REPORTING BUGS

35.1 Introduction

Please report bugs using Samba's Bugzilla <<https://bugzilla.samba.org/>> facilities and take the time to read this file before you submit a bug report. Also, check to see if it has changed between releases, as we may be changing the bug reporting mechanism at some point.

Please do as much as you can yourself to help track down the bug. Samba is maintained by a dedicated group of people who volunteer their time, skills and efforts. We receive far more mail than we can possibly answer, so you have a much higher chance of a response and a fix if you send us a “*developer friendly*” bug report that lets us fix it fast.

Do not assume that if you post the bug to the comp.protocols.smb newsgroup or the mailing list that we will read it. If you suspect that your problem is not a bug but a configuration problem, it is better to send it to the Samba mailing list, as there are thousands of other users on that list who may be able to help you.

You may also like to look through the recent mailing list archives, which are conveniently accessible on the Samba Web pages at <<http://samba.org/samba/>>.

35.2 General Information

Before submitting a bug report, check your config for silly errors. Look in your log files for obvious messages that tell you've mis-configured something. Run testparm to check your config file for correct syntax.

Have you looked through The Samba Checklist? This is extremely important.

If you include part of a log file with your bug report, then be sure to annotate it with exactly what you were doing on the client at the time and exactly what the results were.

35.3 Debug Levels

If the bug has anything to do with Samba behaving incorrectly as a server (like refusing to open a file), then the log files will probably be quite useful. Depending on the problem, a

log level of between 3 and 10 showing the problem may be appropriate. A higher level gives more detail, but may use too much disk space.

To set the debug level, use the log level in your `smb.conf`. You may also find it useful to set the log level higher for just one machine and keep separate logs for each machine. To do this, add the following lines to your main `smb.conf` file:

```
log level = 10
log file = /usr/local/samba/lib/log.%m
include = /usr/local/samba/lib/smb.conf.%m
```

and create a file `/usr/local/samba/lib/smb.conf.machine` where *machine* is the name of the client you wish to debug. In that file put any `smb.conf` commands you want, for example log level may be useful. This also allows you to experiment with different security systems, protocol levels and so on, on just one machine.

The `smb.conf` entry log level is synonymous with the parameter `debuglevel` that has been used in older versions of Samba and is being retained for backward compatibility of `smb.conf` files.

As the log level value is increased, you will record a significantly greater level of debugging information. For most debugging operations, you may not need a setting higher than 3. Nearly all bugs can be tracked at a setting of 10, but be prepared for a large volume of log data.

35.3.1 Debugging Specific Operations

Samba-3.x permits debugging (logging) of specific functional components without unnecessarily cluttering the log files with detailed logs for all operations. An example configuration to achieve this is shown in:

```
log level = 0 tdb:3 passdb:5 auth:4 vfs:2
max log size = 0
log file = /var/log/samba/%U.%m.log
```

This will cause the level of detail to be expanded to the debug class (log level) passed to each functional area per the value shown above. The first value passed to the `log level` of 0 means turn off all unnecessary debugging except the debug classes set for the functional areas as specified. The table shown in Debugable Functions may be used to affect very precise analysis of each SMB operation Samba is conducting.

35.4 Internal Errors

If you get the message “*INTERNAL ERROR*” in your log files, it means that Samba got an unexpected signal while running. It is probably a segmentation fault and almost certainly means a bug in Samba (unless you have faulty hardware or system software).

If the message came from `smbd`, it will probably be accompanied by a message that details the last SMB message received by `smbd`. This information is often useful in tracking down the problem so please include it in your bug report.

Table 35.1. Debuggable Functions

Function Name	Function Name
all	passdb
tdb	sam
printdrivers	auth
lanman	winbind
smb	vfs
rpc_parse	idmap
rpc_srv	quota
rpc_cli	acls

You should also detail how to reproduce the problem, if possible. Please make this reasonably detailed.

You may also find that a core file appeared in a `corefiles` subdirectory of the directory where you keep your Samba log files. This file is the most useful tool for tracking down the bug. To use it, you do this:

```
$ gdb smbd core
```

adding appropriate paths to `smbd` and `core` so `gdb` can find them. If you do not have `gdb`, try `dbx`. Then within the debugger, use the command **where** to give a stack trace of where the problem occurred. Include this in your report.

If you know any assembly language, do a **disass** of the routine where the problem occurred (if its in a library routine, then disassemble the routine that called it) and try to work out exactly where the problem is by looking at the surrounding code. Even if you do not know assembly, including this information in the bug report can be useful.

35.5 Attaching to a Running Process

Unfortunately, some UNIXes (in particular some recent Linux kernels) refuse to dump a core file if the task has changed uid (which `smbd` does often). To debug with this sort of system, you could try to attach to the running process using `gdb smbd PID` where you get `PID` from `smbstatus`. Then use `c` to continue and try to cause the core dump using the client. The debugger should catch the fault and tell you where it occurred.

35.6 Patches

The best sort of bug report is one that includes a fix! If you send us patches, please use `diff -u` format if your version of `diff` supports it, otherwise use `diff -c4`. Make sure you do the diff against a clean version of the source and let me know exactly what version you used.

Part VI

Appendixes

HOW TO COMPILE SAMBA

You can obtain the Samba source from the Samba Website. `<http://samba.org/>` To obtain a development version, you can download Samba from Subversion or using `rsync`.

36.1 Access Samba Source Code via Subversion

36.1.1 Introduction

Samba is developed in an open environment. Developers use a Subversion to “*checkin*” (also known as “*commit*”) new source code. Samba’s various Subversion branches can be accessed via anonymous Subversion using the instructions detailed in this chapter.

This chapter is a modified version of the instructions found at the Samba `<http://samba.org/samba/subversion.html>` web site.

36.1.2 Subversion Access to samba.org

The machine `samba.org` runs a publicly accessible Subversion repository for access to the source code of several packages, including Samba, `rsync`, `distcc`, `ccache`, and `jitterbug`. There are two main ways of accessing the Subversion server on this host:

36.1.2.1 Access via SVNweb

You can access the source code via your favorite WWW browser. This allows you to access the contents of individual files in the repository and also to look at the revision history and commit logs of individual files. You can also ask for a diff listing between any two versions on the repository.

Use the URL: `<http://svnweb.samba.org/>`

36.1.2.2 Access via Subversion

You can also access the source code via a normal Subversion client. This gives you much more control over what you can do with the repository and allows you to checkout whole source

trees and keep them up-to-date via normal Subversion commands. This is the preferred method of access if you are a developer and not just a casual browser.

In order to be able to download the Samba sources off Subversion, you need a Subversion client. Your distribution might include one, or you can download the sources from <http://subversion.tigris.org/>.

To gain access via anonymous Subversion, use the following steps. Retrieving Samba using Subversion

1. Install a recent copy of Subversion. All you really need is a copy of the Subversion client binary.
2. Run the command `svn co svn://svnanon.samba.org/samba/trunk samba`. This will create a directory called `samba` containing the latest Samba source code (usually the branch that is going to be the next major release). This currently corresponds to the 3.1 development tree. Subversion branches other than trunk can be obtained by adding `branches/BRANCH_NAME` to the URL you check out. A list of branch names can be found on the “*Development*” page of the Samba Web site. A common request is to obtain the latest 3.0 release code. This could be done by using the following command: `svn co svn://svnanon.samba.org/samba/branches/SAMBA_3.0 samba_3`.
3. Whenever you want to merge in the latest code changes, use the following command from within the Samba directory: `svn update`

36.2 Accessing the Samba Sources via rsync and ftp

`pserver.samba.org` also exports unpacked copies of most parts of the Subversion tree at the Samba pserver <ftp://pserver.samba.org/pub/unpacked> location and also via anonymous rsync at the Samba rsync <rsync://pserver.samba.org/ftp/unpacked/> server location. I recommend using rsync rather than ftp. See the rsync home-page <http://rsync.samba.org/> for more info on rsync.

The disadvantage of the unpacked trees is that they do not support automatic merging of local changes like Subversion does. `rsync` access is most convenient for an initial install.

36.3 Verifying Samba’s PGP Signature

It is strongly recommended that you verify the PGP signature for any source file before installing it. Even if you’re not downloading from a mirror site, verifying PGP signatures should be a standard reflex. Many people today use the GNU GPG tool-set in place of PGP. GPG can substitute for PGP.

With that said, go ahead and download the following files:

```
$ wget http://us1.samba.org/samba/ftp/samba-3.0.0.tar.asc
$ wget http://us1.samba.org/samba/ftp/samba-pubkey.asc
```

The first file is the PGP signature for the Samba source file; the other is the Samba public PGP key itself. Import the public PGP key with:

```
$ gpg --import samba-pubkey.asc
```

and verify the Samba source code integrity with:

```
$ gzip -d samba-3.0.0.tar.gz
$ gpg --verify samba-3.0.0.tar.asc
```

If you receive a message like, “*Good signature from Samba Distribution Verification Key...*” then all is well. The warnings about trust relationships can be ignored. An example of what you would not want to see would be:

```
gpg: BAD signature from Samba Distribution Verification Key
```

36.4 Building the Binaries

To build the binaries, first run the program `./configure` in the source directory. This should automatically configure Samba for your operating system. If you have unusual needs, then you may wish to run

```
root# ./configure --help
```

first to see what special options you can enable. Now execute `./configure` with any arguments it might need:

```
root# ./configure [... arguments ...]
```

Executing

```
root# make
```

will create the binaries. Once it is successfully compiled you can use

```
root# make install
```

to install the binaries and manual pages. You can separately install the binaries and/or man pages using

```
root# make installbin
```

and

```
root# make installman
```

Note that if you are upgrading from a previous version of Samba you might like to know that the old versions of the binaries will be renamed with an “.old” extension. You can go back to the previous version with

```
root# make revert
```

if you find this version a disaster!

36.4.1 Compiling Samba with Active Directory Support

In order to compile Samba with ADS support, you need to have installed on your system:

- The MIT or Heimdal Kerberos development libraries (either install from the sources or use a package).
- The OpenLDAP development libraries.

If your Kerberos libraries are in a non-standard location, then remember to add the configure option `--with-krb5=DIR`.

After you run configure, make sure that `include/config.h` it generates contain lines like this:

```
#define HAVE_KRB5 1
#define HAVE_LDAP 1
```

If it does not, configure did not find your KRB5 libraries or your LDAP libraries. Look in `config.log` to figure out why and fix it.

36.4.1.1 Installing the Required Packages for Debian

On Debian, you need to install the following packages:

- `libkrb5-dev`
- `krb5-user`

36.4.1.2 Installing the Required Packages for Red Hat Linux

On Red Hat Linux, this means you should have at least:

- `krb5-workstation` (for kinit)
- `krb5-libs` (for linking with)
- `krb5-devel` (because you are compiling from source)

in addition to the standard development environment.

If these files are not installed on your system, you should check the installation CDs to find which has them and install the files using your tool of choice. If in doubt about what tool to use, refer to the Red Hat Linux documentation.

36.4.1.3 SuSE Linux Package Requirements

SuSE Linux installs Heimdal packages that may be required to allow you to build binary packages. You should verify that the development libraries have been installed on your system.

SuSE Linux Samba RPMs support Kerberos. Please refer to the documentation for your SuSE Linux system for information regarding SuSE Linux specific configuration. Additionally, SuSE are very active in the maintenance of Samba packages that provide the maximum capabilities that are available. You should consider using SuSE provided packages where they are available.

36.5 Starting the `smbd` and `nmbd`

You must choose to start `smbd` and `nmbd` either as daemons or from `inetd`. Don't try to do both! Either you can put them in `inetd.conf` and have them started on demand by `inetd` or `xinetd`, or you can start them as daemons either from the command line or in `/etc/rc.local`. See the man pages for details on the command line options. Take particular care to read the bit about what user you need to have to start Samba. In many cases, you must be root.

The main advantage of starting `smbd` and `nmbd` using the recommended daemon method is that they will respond slightly more quickly to an initial connection request.

36.5.1 Starting from `inetd.conf`

NOTE



The following will be different if you use NIS, NIS+ or LDAP to distribute services maps.

Look at your `/etc/services`. What is defined at port 139/tcp? If nothing is defined, then add a line like this:

```
netbios-ssn    139/tcp
```

Similarly for 137/udp, you should have an entry like:

```
netbios-ns    137/udp
```

Next, edit your `/etc/inetd.conf` and add two lines like this:

```
netbios-ssn stream tcp nowait root /usr/local/samba/bin/smbd smbd
netbios-ns dgram udp wait root /usr/local/samba/bin/nmbd nmbd
```

The exact syntax of `/etc/inetd.conf` varies between UNIXes. Look at the other entries in `inetd.conf` for a guide.

Some distributions use `xinetd` instead of `inetd`. Consult the `xinetd` manual for configuration information.

NOTE



Some UNIXes already have entries like `netbios.ns` (note the underscore) in `/etc/services`. You must edit `/etc/services` or `/etc/inetd.conf` to make them consistent.

NOTE



On many systems you may need to use the `interfaces` option in `smb.conf` to specify the IP address and netmask of your interfaces. Run `ifconfig` as `root` if you do not know what the broadcast is for your net. `nmbd` tries to determine it at run time, but fails on some UNIXes.

WARNING

Many UNIXes only accept around five parameters on the command line in `inetd.conf`. This means you shouldn't use spaces between the options and arguments, or you should use a script and start the script from **`inetd`**.

Restart `inetd`, perhaps just send it a HUP.

```
root# killall -HUP inetd
```

36.5.2 Alternative: Starting `smbd` as a Daemon

To start the server as a daemon, you should create a script something like this one, perhaps calling it `start smb`.

```
#!/bin/sh
/usr/local/samba/bin/smbd -D
/usr/local/samba/bin/nmbd -D
```

Make it executable with `chmod +x start smb`

You can then run `start smb` by hand or execute it from `/etc/rc.local`.

To kill it, send a kill signal to the processes `nmbd` and `smbd`.

NOTE



If you use the SVR4 style init system, you may like to look at the `examples/svr4-startup` script to make Samba fit into that system.

PORTABILITY

Samba works on a wide range of platforms but the interface all the platforms provide is not always compatible. This chapter contains platform-specific information about compiling and using Samba.

37.1 HP-UX

HP's implementation of supplementary groups is non-standard (for historical reasons). There are two group files, `/etc/group` and `/etc/logingroup`; the system maps UIDs to numbers using the former, but `initgroups()` reads the latter. Most system Admins who know the ropes symlink `/etc/group` to `/etc/logingroup` (hard link does not work for reasons too obtuse to go into here). `initgroups()` will complain if one of the groups you're in in `/etc/logingroup` has what it considers to be an invalid ID, which means outside the range `[0..UID_MAX]`, where `UID_MAX` is (I think) 60000 currently on HP-UX. This precludes -2 and 65534, the usual `nobody` GIDs.

If you encounter this problem, make sure the programs that are failing to `initgroups()` are run as users, not in any groups with GIDs outside the allowed range.

This is documented in the HP manual pages under `setgroups(2)` and `passwd(4)`.

On HP-UX you must use `gcc` or the HP ANSI compiler. The free compiler that comes with HP-UX is not ANSI compliant and cannot compile Samba.

37.2 SCO UNIX

If you run an old version of SCO UNIX, you may need to get important TCP/IP patches for Samba to work correctly. Without the patch, you may encounter corrupt data transfers using Samba.

The patch you need is UOD385 Connection Drivers SLS. It is available from SCO (<ftp.sco.com> <<ftp://ftp.sco.com/>>, directory SLS, files `uod385a.Z` and `uod385a.ltr.Z`).

The information provided here refers to an old version of SCO UNIX. If you require binaries for more recent SCO UNIX products, please contact SCO to obtain packages that are ready to install. You should also verify with SCO that your platform is up-to-date for the binary

packages you will install. This is important if you wish to avoid data corruption problems with your installation. To build Samba for SCO UNIX products may require significant patching of Samba source code. It is much easier to obtain binary packages directly from SCO.

37.3 DNIX

DNIX has a problem with `seteuid()` and `setegid()`. These routines are needed for Samba to work correctly, but they were left out of the DNIX C library for some reason.

For this reason Samba by default defines the macro `NO_EID` in the DNIX section of `includes.h`. This works around the problem in a limited way, but it is far from ideal, and some things still will not work right.

To fix the problem properly, you need to assemble the following two functions and then either add them to your C library or link them into Samba. Put the following in the file `setegid.s`:

```

        .globl  _setegid
_setegid:
        moveq   #47,d0
        movl    #100,a0
        moveq   #1,d1
        movl    4(sp),a1
        trap    #9
        bccs   1$
        jmp     cerror
1$:
        clrl   d0
        rts

```

Put this in the file `seteuid.s`:

```

        .globl  _seteuid
_seteuid:
        moveq   #47,d0
        movl    #100,a0
        moveq   #0,d1
        movl    4(sp),a1
        trap    #9
        bccs   1$
        jmp     cerror
1$:
        clrl   d0
        rts

```

After creating the above files, you then assemble them using

```
$ as seteuid.s
$ as setegid.s
```

that should produce the files `seteuid.o` and `setegid.o`

Then you need to add these to the LIBSM line in the DNIX section of the Samba Makefile. Your LIBSM line will then look something like this:

```
LIBSM = setegid.o seteuid.o -ln
```

You should then remove the line:

```
#define NO_EID
```

from the DNIX section of `includes.h`.

37.4 Red Hat Linux

By default during installation, some versions of Red Hat Linux add an entry to `/etc/hosts` as follows:

```
127.0.0.1 loopback "hostname"."domainname"
```

This causes Samba to loop back onto the loopback interface. The result is that Samba fails to communicate correctly with the world and therefore may fail to correctly negotiate who is the master browse list holder and who is the master browser.

Corrective Action: Delete the entry after the word "loopback" in the line starting 127.0.0.1.

37.5 AIX

37.5.1 Sequential Read Ahead

Disabling Sequential Read Ahead using `vmtune -r 0` improves Samba performance significantly.

37.6 Solaris

37.6.1 Locking Improvements

Some people have been experiencing problems with `F_SETLKW64/fcntl` when running Samba on Solaris. The built-in file locking mechanism was not scalable. Performance would degrade to the point where processes would get into loops of trying to lock a file. It would try a lock, then fail, then try again. The lock attempt was failing before the grant was occurring. So the visible manifestation of this would be a handful of processes stealing all of the CPU, and when they were truss-ed they would be stuck if `F_SETLKW64` loops.

Sun released patches for Solaris 2.6, 8, and 9. The patch for Solaris 7 has not been released yet.

The patch revision for 2.6 is 105181-34, for 8 is 108528-19 and for 9 is 112233-04.

After the install of these patches, it is recommended to reconfigure and rebuild Samba.

Thanks to Joe Meslovich for reporting this.

37.6.2 Winbind on Solaris 9

Nsswitch on Solaris 9 refuses to use the Winbind NSS module. This behavior is fixed by Sun in patch 112960-14 <<http://sunsolve.sun.com/pub-cgi/findPatch.pl?patchId=112960;rev=14>>.

SAMBA AND OTHER CIFS CLIENTS

This chapter contains client-specific information.

38.1 Macintosh Clients

Yes. Thursby <<http://www.thursby.com/>> has a CIFS Client/Server called DAVE. <<http://www.thursby.com/products/dave.html>> They test it against Windows 95, Windows NT /200x/XP and Samba for compatibility issues. At the time of this writing, DAVE was at version 4.1. Please refer to Thursby's Web site for more information regarding this product.

Alternatives — There are two free implementations of AppleTalk for several kinds of UNIX machines and several more commercial ones. These products allow you to run file services and print services natively to Macintosh users, with no additional support required on the Macintosh. The two free implementations are Netatalk, <<http://www.umich.edu/~rsug/netatalk/>> and CAP. <<http://www.cs.mu.oz.au/appletalk/atalk.html>> What Samba offers MS Windows users, these packages offer to Macs. For more info on these packages, Samba, and Linux (and other UNIX-based systems), see http://www.eats.com/linux_mac_win.html <http://www.eats.com/linux_mac_win.html>

Newer versions of the Macintosh (Mac OS X) include Samba.

38.2 OS2 Client

38.2.1 Configuring OS/2 Warp Connect or OS/2 Warp 4

Basically, you need three components:

- The File and Print Client (IBM Peer)
- TCP/IP (Internet support)
- The “*NetBIOS over TCP/IP*” driver (TCPBEUI)

Installing the first two together with the base operating system on a blank system is explained in the Warp manual. If Warp has already been installed, but you now want to install the networking support, use the “*Selective Install for Networking*” object in the “*System Setup*” folder.

Adding the “*NetBIOS over TCP/IP*” driver is not described in the manual and just barely in the online documentation. Start **MPTS.EXE**, click on **OK**, click on **Configure LAPS** and click on **IBM OS/2 NETBIOS OVER TCP/IP** in **Protocols**. This line is then moved to **Current Configuration**. Select that line, click on **Change number** and increase it from 0 to 1. Save this configuration.

If the Samba server is not on your local subnet, you can optionally add IP names and addresses of these servers to the **Names List**, or specify a WINS server (NetBIOS Nameserver in IBM and RFC terminology). For Warp Connect, you may need to download an update for IBM Peer to bring it on the same level as Warp 4. See the Web page mentioned above.

38.2.2 Configuring Other Versions of OS/2

This sections deals with configuring OS/2 Warp 3 (not Connect), OS/2 1.2, 1.3 or 2.x.

You can use the free Microsoft LAN Manager 2.2c Client for OS/2 that is available from <ftp://ftp.microsoft.com/BusSys/Clients/LANMAN.OS2/> <<ftp://ftp.microsoft.com/BusSys/Clients/LANMAN.OS2/>>. In a nutshell, edit the file \OS2VER in the root directory of the OS/2 boot partition and add the lines:

```
20=setup.exe
20=netwksta.sys
20=netvdd.sys
```

before you install the client. Also, do not use the included NE2000 driver because it is buggy. Try the NE2000 or NS2000 driver from <ftp://ftp.cdrom.com/pub/os2/network/ndis/> <<ftp://ftp.cdrom.com/pub/os2/network/ndis/>> instead.

38.2.3 Printer Driver Download for OS/2 Clients

Create a share called [*PRINTDRV*] that is world-readable. Copy your OS/2 driver files there. The *.EA_* files must still be separate, so you will need to use the original install files and not copy an installed driver from an OS/2 system.

Install the NT driver first for that printer. Then, add to your *smb.conf* a parameter, *os2 driver map = filename*. Next, in the file specified by *filename*, map the name of the NT driver name to the OS/2 driver name as follows:

```
nt driver name = os2 driver name.device name, e.g.
```

```
HP LaserJet 5L = LASERJET.HP LaserJet 5L
```

You can have multiple drivers mapped in this file.

If you only specify the OS/2 driver name, and not the device name, the first attempt to download the driver will actually download the files, but the OS/2 client will tell you the driver is not available. On the second attempt, it will work. This is fixed simply by adding the device name to the mapping, after which it will work on the first attempt.

38.3 Windows for Workgroups

38.3.1 Latest TCP/IP Stack from Microsoft

Use the latest TCP/IP stack from Microsoft if you use Windows for Workgroups. The early TCP/IP stacks had lots of bugs.

Microsoft has released an incremental upgrade to their TCP/IP 32-bit VxD drivers. The latest release can be found on their ftp site at <ftp.microsoft.com>, located in `/Softlib/MSLFILES/TCP32B.EXE`. There is an `update.txt` file there that describes the problems that were fixed. New files include `WINSOCK.DLL`, `TELNET.EXE`, `WSOCK.386`, `VNBT.386`, `WSTCP.386`, `TRACERT.EXE`, `NETSTAT.EXE`, and `NBTSTAT.EXE`.

More information about this patch is available in Knowledge base article 99891 <<http://support.microsoft.com/kb/q99891/>>.

38.3.2 Delete .pwl Files After Password Change

Windows for Workgroups does a lousy job with passwords. When you change passwords on either the UNIX box or the PC, the safest thing to do is to delete the `.pwl` files in the Windows directory. The PC will complain about not finding the files, but will soon get over it, allowing you to enter the new password.

If you do not do this, you may find that Windows for Workgroups remembers and uses the old password, even if you told it a new one.

Often Windows for Workgroups will totally ignore a password you give it in a dialog box.

38.3.3 Configuring Windows for Workgroups Password Handling

There is a program call `admincfg.exe` on the last disk (disk 8) of the WFW 3.11 disk set. To install it, type `EXPAND A:\ADMINCFG.EX_ C:\WINDOWS\ADMINCFG.EXE`. Then add an icon for it via the Program Manager **New** Menu. This program allows you to control how WFW handles passwords, i.e., Disable Password Caching and so on. for use with `security = user`.

38.3.4 Password Case Sensitivity

Windows for Workgroups uppercases the password before sending it to the server. UNIX passwords can be case-sensitive though. Check the `smb.conf` information on password level to specify what characters Samba should try to uppercase when checking.

38.3.5 Use TCP/IP as Default Protocol

To support print queue reporting, you may find that you have to use TCP/IP as the default protocol under Windows for Workgroups. For some reason, if you leave NetBEUI as the default, it may break the print queue reporting on some systems. It is presumably a Windows for Workgroups bug.

38.3.6 Speed Improvement

Note that some people have found that setting *DefaultRcvWindow* in the *[MSTCP]* section of the *SYSTEM.INI* file under Windows for Workgroups to 3072 gives a big improvement.

My own experience with *DefaultRcvWindow* is that I get a much better performance with a large value (16384 or larger). Other people have reported that anything over 3072 slows things down enormously. One person even reported a speed drop of a factor of 30 when he went from 3072 to 8192.

38.4 Windows 95/98

When using Windows 95 OEM SR2, the following updates are recommended where Samba is being used. Please note that the above change will effect you once these updates have been installed.

There are more updates than the ones mentioned here. You are referred to the Microsoft Web site for all currently available updates to your specific version of Windows 95.

Kernel Update: KRNLUPD.EXE
Ping Fix: PINGUPD.EXE
RPC Update: RPCRTUPD.EXE
TCP/IP Update: VIPUPD.EXE
Redirector Update: VRDRUPD.EXE

Also, if using MS Outlook, it is desirable to install the **OLEUPD.EXE** fix. This fix may stop your machine from hanging for an extended period when exiting Outlook and you may notice a significant speedup when accessing network neighborhood services.

38.4.1 Speed Improvement

Configure the Windows 95 TCP/IP registry settings to give better performance. I use a program called **MTUSPEED.exe** that I got off the Internet. There are various other utilities of this type freely available.

38.5 Windows 2000 Service Pack 2

There are several annoyances with Windows 2000 SP2. One of which only appears when using a Samba server to host user profiles to Windows 2000 SP2 clients in a Windows domain. This assumes that Samba is a member of the domain, but the problem will most likely occur if it is not.

In order to serve profiles successfully to Windows 2000 SP2 clients (when not operating as a PDC), Samba must have `nt acl support = no` added to the file share which houses the roaming profiles. If this is not done, then the Windows 2000 SP2 client will complain about not being able to access the profile (Access Denied) and create multiple copies of it on disk (DOMAIN.user.001, DOMAIN.user.002, and so on). See the `smb.conf` man page for more details on this option. Also note that the `nt acl support` parameter was formally a global parameter in releases prior to Samba 2.2.2.

Following example provides a minimal profile share.

Example 38.5.1. Minimal profile share

```
[profile]
    path = /export/profile
    create mask = 0600
    directory mask = 0700
    nt acl support = no
    read only = no
```

The reason for this bug is that the Windows 200x SP2 client copies the security descriptor for the profile that contains the Samba server's SID, and not the domain SID. The client compares the SID for SAMBA\user and realizes it is different from the one assigned to DOMAIN\user. Hence, the reason for the access denied message.

By disabling the `nt acl support` parameter, Samba will send the Windows 200x client a response to the QuerySecurityDescriptor trans2 call, which causes the client to set a default ACL for the profile. This default ACL includes:

```
DOMAIN\user "Full Control">
```

NOTE



This bug does not occur when using Winbind to create accounts on the Samba host for Domain users.

38.6 Windows NT 3.1

If you have problems communicating across routers with Windows NT 3.1 workstations, read this Microsoft Knowledge Base article. <<http://support.microsoft.com/default.aspx?scid=kb;Q103765>>

SAMBA PERFORMANCE TUNING

39.1 Comparisons

The Samba server uses TCP to talk to the client. Thus if you are trying to see if it performs well, you should really compare it to programs that use the same protocol. The most readily available programs for file transfer that use TCP are ftp or another TCP-based SMB server.

If you want to test against something like an NT or Windows for Workgroups server, then you will have to disable all but TCP on either the client or server. Otherwise, you may well be using a totally different protocol (such as NetBEUI) and comparisons may not be valid.

Generally, you should find that Samba performs similarly to ftp at raw transfer speed. It should perform quite a bit faster than NFS, although this depends on your system.

Several people have done comparisons between Samba and Novell, NFS or Windows NT. In some cases Samba performed the best, in others the worst. I suspect the biggest factor is not Samba versus some other system, but the hardware and drivers used on the various systems. Given similar hardware, Samba should certainly be competitive in speed with other systems.

39.2 Socket Options

There are a number of socket options that can greatly affect the performance of a TCP-based server like Samba.

The socket options that Samba uses are settable both on the command line with the `-O` option, or in the `smb.conf` file.

The socket options section of the `smb.conf` manual page describes how to set these and gives recommendations.

Getting the socket options correct can make a big difference to your performance, but getting them wrong can degrade it by just as much. The correct settings are very dependent on your local network.

The socket option `TCP_NODELAY` is the one that seems to make the biggest single difference for most networks. Many people report that adding socket options = `TCP_NODELAY` doubles the read performance of a Samba drive. The best explanation I have seen for this is that the Microsoft TCP/IP stack is slow in sending TCP ACKs.

There have been reports that setting `socket options = SO_RCVBUF=8192` in `smb.conf` can seriously degrade Samba performance on the loopback adaptor (IP Address 127.0.0.1). It is strongly recommended that before specifying any settings for `socket options` the effect first be quantitatively measured on the server being configured.

39.3 Read Size

The option read size affects the overlap of disk reads/writes with network reads/writes. If the amount of data being transferred in several of the SMB commands (currently `SMBwrite`, `SMBwriteX` and `SMBreadbrow`) is larger than this value, then the server begins writing the data before it has received the whole packet from the network, or in the case of `SMBreadbrow`, it begins writing to the network before all the data has been read from disk.

This overlapping works best when the speeds of disk and network access are similar, having little effect when the speed of one is much greater than the other.

The default value is 16384, but little experimentation has been done as yet to determine the optimal value, and it is likely that the best value will vary greatly between systems anyway. A value over 65536 is pointless and will cause you to allocate memory unnecessarily.

39.4 Max Xmit

At startup the client and server negotiate a *maximum transmit* size, which limits the size of nearly all SMB commands. You can set the maximum size that Samba will negotiate using the `max xmit` option in `smb.conf`. Note that this is the maximum size of SMB requests that Samba will accept, but not the maximum size that the client will accept. The client maximum receive size is sent to Samba by the client and Samba honors this limit.

It defaults to 65536 bytes (the maximum), but it is possible that some clients may perform better with a smaller transmit unit. Trying values of less than 2048 is likely to cause severe problems. In most cases the default is the best option.

39.5 Log Level

If you set the log level (also known as debug level) higher than 2 then you may suffer a large drop in performance. This is because the server flushes the log file after each operation, which can be quite expensive.

39.6 Read Raw

The read raw operation is designed to be an optimized, low-latency file read operation. A server may choose to not support it, however, and Samba makes support for read raw optional, with it being enabled by default.

In some cases clients do not handle read raw very well and actually get lower performance using it than they get using the conventional read operations.

So you might like to try read raw = no and see what happens on your network. It might lower, raise or not effect your performance. Only testing can really tell.

39.7 Write Raw

The write raw operation is designed to be an optimized, low-latency file write operation. A server may choose to not support it, however, and Samba makes support for write raw optional, with it being enabled by default.

Some machines may find write raw slower than normal write, in which case you may wish to change this option.

39.8 Slow Logins

Slow logins are almost always due to the password checking time. Using the lowest practical password level will improve things.

39.9 Client Tuning

Often a speed problem can be traced to the client. The client (for example Windows for Workgroups) can often be tuned for better TCP performance. Check the sections on the various clients in Samba and Other CIFS Clients.

39.10 Samba Performance Problem Due to Changing Linux Kernel

A user wrote the following to the mailing list:

I am running Gentoo on my server and Samba 2.2.8a. Recently I changed kernel version from `linux-2.4.19-gentoo-r10` to `linux-2.4.20-wolk4.0s`. And now I have a performance issue with Samba. Many of you will probably say, “*Move to vanilla sources!*” Well, I tried that and it didn’t work. I have a 100mb LAN and two computers (Linux and Windows 2000). The Linux server shares directories with DivX files, the client (Windows 2000) plays them via LAN. Before when I was running the 2.4.19 kernel everything was fine, but now movies freeze and stop. I tried moving files between the server and Windows and it is terribly slow.

The answer he was given is:

Grab the mii-tool and check the duplex settings on the NIC. My guess is that it is a link layer issue, not an application layer problem. Also run ifconfig and verify that the framing error, collisions, and so on, look normal for ethernet.

39.11 Corrupt tdb Files

Our Samba PDC server has been hosting three TB of data to our 500+ users [Windows NT/XP] for the last three years using Samba without a problem. Today all shares went very slow. Also the main smbd kept spawning new processes so we had 1600+ running smbd's (normally we avg. 250). It crashed the SUN E3500 cluster twice. After a lot of searching, I decided to **rm /var/locks/*.tdb**. Happy again.

Question: Is there any method of keeping the *.tdb files in top condition or how can I detect early corruption?

Answer: Yes, run **tdbbackup** each time after stopping nmbd and before starting nmbd.

Question: What I also would like to mention is that the service latency seems a lot lower than before the locks cleanup. Any ideas on keeping it top notch?

Answer: Yes. Same answer as for previous question!

39.12 Samba Performance is Very Slow

A site reported experiencing very baffling symptoms with MYOB Premier opening and accessing it's data-files. Some operations on the file would take between 40 and 45 seconds.

It turned out that the printer monitor program running on the windows clients was causing the problems. From the logs, we saw activity coming through with pauses of about 1 second.

Stopping the monitor software resulted in the networks access at normal (quick) speed. Restarting the program caused the speed to slow down again. The printer was a cannon lbp810 and the relevant task was something like CAPON (not sure on spelling). The monitor software displayed a printing now dialog on the client during printing.

We discovered this by starting with a clean install of windows and trying the app at every step of the installation of other software process (had to do this many times).

Moral of the story, check everything (other software included)!

DNS AND DHCP CONFIGURATION GUIDE

40.1 Features and Benefits

There are few subjects in the UNIX world that might raise as much contention as Domain Name System (DNS) and Dynamic Host Configuration Protocol (DHCP). Not all opinions held for or against particular implementations of DNS and DHCP are valid.

We live in a modern age where many information technology users demand mobility and freedom. Microsoft Windows users in particular expect to be able to plug their notebook computer into a network port and have things “*just work.*”

UNIX administrators have a point. Many of the normative practices in the Microsoft Windows world at best border on bad practice from a security perspective. Microsoft Windows networking protocols allow workstations to arbitrarily register themselves on a network. Windows 2000 Active Directory registers entries in the DNS name space that are equally perplexing to UNIX administrators. Welcome to the new world!

The purpose of this chapter is to demonstrate the configuration of the Internet Software Consortium (ISC) DNS and DHCP servers to provide dynamic services that are compatible with their equivalents in the Microsoft Windows 2000 Server products.

The purpose of this chapter is to provide no more than a working example of configuration files for both DNS and DHCP servers. The examples used match configuration examples used elsewhere in this document.

This chapter explicitly does not provide a tutorial, nor does it pretend to be a reference guide on DNS and DHCP, as this is well beyond the scope and intent of this document as a whole. Anyone who wants more detailed reference materials on DNS or DHCP should visit the ISC Web sites at <http://www.isc.org> <<http://www.isc.org>>. Those wanting a written text might also be interested in the O’Reilly publications on these two subjects.

40.2 Example Configuration

The domain name system is to the Internet what water is to life. By it nearly all information resources (host names) are resolved to their Internet protocol (IP) address. Win-

dows networking tried hard to avoid the complexities of DNS, but alas, DNS won. The alternative to DNS, the Windows Internet Name Service (WINS) an artifact of NetBIOS networking over the TCP/IP protocols, has demonstrated scalability problems as well as a flat non-hierarchical name space that became unmanageable as the size and complexity of information technology networks grew.

WINS is a Microsoft implementation of the RFC1001/1002 NetBIOS Name Service (NBNS). It allows NetBIOS clients (like Microsoft Windows Machines) to register an arbitrary machine name that the administrator or user has chosen together with the IP address that the machine has been given. Through the use of WINS, network client machines could resolve machine names to their IP address.

The demand for an alternative to the limitations of NetBIOS networking finally drove Microsoft to use DNS and Active Directory. Microsoft's new implementation attempts to use DNS in a manner similar to the way that WINS is used for NetBIOS networking. Both WINS and Microsoft DNS rely on dynamic name registration.

Microsoft Windows clients can perform dynamic name registration to the DNS server on start-up. Alternately, where DHCP is used to assign workstation IP addresses, it is possible to register host names and their IP address by the DHCP server as soon as a client acknowledges an IP address lease. Lastly, Microsoft DNS can resolve hostnames via Microsoft WINS.

The following configurations demonstrate a simple insecure Dynamic DNS server and a simple DHCP server that matches the DNS configuration.

40.2.1 Dynamic DNS

The example DNS configuration is for a private network in the IP address space for network 192.168.1.0/24. The private class network address space is set forth in RFC1918.

It is assumed that this network will be situated behind a secure firewall. The files that follow work with ISC BIND version 9. BIND is the Berkeley Internet Name Daemon. The following configuration files are offered:

The master configuration file `/etc/named.conf` determines the location of all further configuration files used. The location and name of this file is specified in the start-up script that is part of the operating system.

```
# Quenya.Org configuration file
```

```
acl mynet {
    192.168.1.0/24;
    127.0.0.1;
};

options {
    directory "/var/named";
    listen-on-v6 { any; };
};
```

```
notify no;
forward first;
forwarders {
    192.168.1.1;
};
auth-nxdomain yes;
multiple-cnames yes;
listen-on {
    mynet;
};
};
```

```
# The following three zone definitions do not need any modification.
# The first one defines localhost while the second defines the
# reverse lookup for localhost. The last zone "." is the
# definition of the root name servers.
```

```
zone "localhost" in {
    type master;
    file "localhost.zone";
};
```

```
zone "0.0.127.in-addr.arpa" in {
    type master;
    file "127.0.0.zone";
};
```

```
zone "." in {
    type hint;
    file "root.hint";
};
```

```
# You can insert further zone records for your own domains below.
```

```
zone "kenya.org" {
    type master;
    file "/var/named/kenya.org.hosts";
    allow-query {
        mynet;
    };
    allow-transfer {
        mynet;
    };
    allow-update {
        mynet;
    };
};
```

```

zone "1.168.192.in-addr.arpa" {
    type master;
    file "/var/named/192.168.1.0.rev";
    allow-query {
        mynet;
    };
    allow-transfer {
        mynet;
    };
    allow-update {
        mynet;
    };
};

```

The following files are all located in the directory `/var/named`. This is the `/var/named/localhost.zone` file:

```

$TTL 1W
@           IN SOA  @   root (
            42           ; serial (d. adams)
            2D           ; refresh
            4H           ; retry
            6W           ; expiry
            1W )         ; minimum

            IN NS      @
            IN A        127.0.0.1

```

The `/var/named/127.0.0.zone` file:

```

$TTL 1W
@           IN SOA      localhost. root.localhost. (
            42           ; serial (d. adams)
            2D           ; refresh
            4H           ; retry
            6W           ; expiry
            1W )         ; minimum

            IN NS      localhost.
1           IN PTR      localhost.

```

The `/var/named/kenya.org.host` file:

```

$ORIGIN .
$TTL 38400           ; 10 hours 40 minutes

```

```

quenya.org      IN SOA  marvel.quenya.org. root.quenya.org. (
                2003021832 ; serial
                10800      ; refresh (3 hours)
                3600       ; retry (1 hour)
                604800     ; expire (1 week)
                38400      ; minimum (10 hours 40 minutes)
                )
                NS       marvel.quenya.org.
                MX       10 mail.quenya.org.
$ORIGIN quenya.org.
frodo           A       192.168.1.1
marvel          A       192.168.1.2
;
mail           CNAME   marvel
www           CNAME   marvel

```

The `/var/named/192.168.1.0.rev` file:

```

$ORIGIN .
$TTL 38400      ; 10 hours 40 minutes
1.168.192.in-addr.arpa IN SOA  marvel.quenya.org. root.quenya.org. (
                2003021824 ; serial
                10800      ; refresh (3 hours)
                3600       ; retry (1 hour)
                604800     ; expire (1 week)
                38400      ; minimum (10 hours 40 minutes)
                )
                NS       marvel.quenya.org.
$ORIGIN 1.168.192.in-addr.arpa.
1           PTR      frodo.quenya.org.
2           PTR      marvel.quenya.org.

```

The above were copied from a fully working system. All dynamically registered entries have been removed. In addition to these files, BIND version 9 will create for each of the dynamic registration files a file that has a `.jnl` extension. Do not edit or tamper with the configuration files or with the `.jnl` files that are created.

40.2.2 DHCP Server

The following file is used with the ISC DHCP Server version 3. The file is located in `/etc/dhcpd.conf`:

```

ddns-updates on;
ddns-domainname "quenya.org";
option ntp-servers 192.168.1.2;

```

```
ddns-update-style ad-hoc;
allow unknown-clients;
default-lease-time 86400;
max-lease-time 172800;

option domain-name "kenya.org";
option domain-name-servers 192.168.1.2;
option netbios-name-servers 192.168.1.2;
option netbios-dd-server 192.168.1.2;
option netbios-node-type 8;

subnet 192.168.1.0 netmask 255.255.255.0 {
    range dynamic-bootp 192.168.1.60 192.168.1.254;
    option subnet-mask 255.255.255.0;
    option routers 192.168.1.2;
    allow unknown-clients;
}
```

In the above example, IP addresses between 192.168.1.1 and 192.168.1.59 are reserved for fixed address (commonly called **hard-wired**) IP addresses. The addresses between 192.168.1.60 and 192.168.1.254 are allocated for dynamic use.

GNU GENERAL PUBLIC LICENSE

A.1 Preamble

The licenses for most software are designed to take away your freedom to share and change it. By contrast, the GNU General Public License is intended to guarantee your freedom to share and change free software - to make sure the software is free for all its users. This General Public License applies to most of the Free Software Foundation's software and to any other program whose authors commit to using it. (Some other Free Software Foundation software is covered by the GNU Library General Public License instead.) You can apply it to your programs, too.

When we speak of free software, we are referring to freedom, not price. Our General Public Licenses are designed to make sure that you have the freedom to distribute copies of free software (and charge for this service if you wish), that you receive source code or can get it if you want it, that you can change the software or use pieces of it in new free programs; and that you know you can do these things.

To protect your rights, we need to make restrictions that forbid anyone to deny you these rights or to ask you to surrender the rights. These restrictions translate to certain responsibilities for you if you distribute copies of the software, or if you modify it.

For example, if you distribute copies of such a program, whether gratis or for a fee, you must give the recipients all the rights that you have. You must make sure that they, too, receive or can get the source code. And you must show them these terms so they know their rights.

We protect your rights with two steps:

1. copyright the software, and
2. offer you this license which gives you legal permission to copy, distribute and/or modify the software.

Also, for each author's protection and ours, we want to make certain that everyone understands that there is no warranty for this free software. If the software is modified by someone else and passed on, we want its recipients to know that what they have is not the

original, so that any problems introduced by others will not reflect on the original authors' reputations.

Finally, any free program is threatened constantly by software patents. We wish to avoid the danger that redistributors of a free program will individually obtain patent licenses, in effect making the program proprietary. To prevent this, we have made it clear that any patent must be licensed for everyone's free use or not licensed at all.

The precise terms and conditions for copying, distribution and modification follow.

A.2 TERMS AND CONDITIONS FOR COPYING, DISTRIBUTION AND MODIFICATION

A.2.1 Section 0

This License applies to any program or other work which contains a notice placed by the copyright holder saying it may be distributed under the terms of this General Public License. The "Program", below, refers to any such program or work, and a "*work based on the Program*" means either the Program or any derivative work under copyright law: that is to say, a work containing the Program or a portion of it, either verbatim or with modifications and/or translated into another language. (Hereinafter, translation is included without limitation in the term "*modification*".) Each licensee is addressed as "*you*".

Activities other than copying, distribution and modification are not covered by this License; they are outside its scope. The act of running the Program is not restricted, and the output from the Program is covered only if its contents constitute a work based on the Program (independent of having been made by running the Program). Whether that is true depends on what the Program does.

A.2.2 Section 1

You may copy and distribute verbatim copies of the Program's source code as you receive it, in any medium, provided that you conspicuously and appropriately publish on each copy an appropriate copyright notice and disclaimer of warranty; keep intact all the notices that refer to this License and to the absence of any warranty; and give any other recipients of the Program a copy of this License along with the Program.

You may charge a fee for the physical act of transferring a copy, and you may at your option offer warranty protection in exchange for a fee.

A.2.3 Section 2

You may modify your copy or copies of the Program or any portion of it, thus forming a work based on the Program, and copy and distribute such modifications or work under the terms of Section 1 above, provided that you also meet all of these conditions:

1. You must cause the modified files to carry prominent notices stating that you changed the files and the date of any change.

2. You must cause any work that you distribute or publish, that in whole or in part contains or is derived from the Program or any part thereof, to be licensed as a whole at no charge to all third parties under the terms of this License.
3. If the modified program normally reads commands interactively when run, you must cause it, when started running for such interactive use in the most ordinary way, to print or display an announcement including an appropriate copyright notice and a notice that there is no warranty (or else, saying that you provide a warranty) and that users may redistribute the program under these conditions, and telling the user how to view a copy of this License.

EXCEPTION:

If the Program itself is interactive but does not normally print such an announcement, your work based on the Program is not required to print an announcement.)

These requirements apply to the modified work as a whole. If identifiable sections of that work are not derived from the Program, and can be reasonably considered independent and separate works in themselves, then this License, and its terms, do not apply to those sections when you distribute them as separate works. But when you distribute the same sections as part of a whole which is a work based on the Program, the distribution of the whole must be on the terms of this License, whose permissions for other licensees extend to the entire whole, and thus to each and every part regardless of who wrote it.

Thus, it is not the intent of this section to claim rights or contest your rights to work written entirely by you; rather, the intent is to exercise the right to control the distribution of derivative or collective works based on the Program.

In addition, mere aggregation of another work not based on the Program with the Program (or with a work based on the Program) on a volume of a storage or distribution medium does not bring the other work under the scope of this License.

A.2.4 Section 3

You may copy and distribute the Program (or a work based on it, under Section 2 in object code or executable form under the terms of Sections 1 and 2 above provided that you also do one of the following:

1. Accompany it with the complete corresponding machine-readable source code, which must be distributed under the terms of Sections 1 and 2 above on a medium customarily used for software interchange; or,
2. Accompany it with a written offer, valid for at least three years, to give any third party, for a charge no more than your cost of physically performing source distribution, a complete machine-readable copy of the corresponding source code, to be distributed under the terms of Sections 1 and 2 above on a medium customarily used for software interchange; or,

3. Accompany it with the information you received as to the offer to distribute corresponding source code. (This alternative is allowed only for noncommercial distribution and only if you received the program in object code or executable form with such an offer, in accord with Subsection b above.)

The source code for a work means the preferred form of the work for making modifications to it. For an executable work, complete source code means all the source code for all modules it contains, plus any associated interface definition files, plus the scripts used to control compilation and installation of the executable. However, as a special exception, the source code distributed need not include anything that is normally distributed (in either source or binary form) with the major components (compiler, kernel, and so on) of the operating system on which the executable runs, unless that component itself accompanies the executable.

If distribution of executable or object code is made by offering access to copy from a designated place, then offering equivalent access to copy the source code from the same place counts as distribution of the source code, even though third parties are not compelled to copy the source along with the object code.

A.2.5 Section 4

You may not copy, modify, sublicense, or distribute the Program except as expressly provided under this License. Any attempt otherwise to copy, modify, sublicense or distribute the Program is void, and will automatically terminate your rights under this License. However, parties who have received copies, or rights, from you under this License will not have their licenses terminated so long as such parties remain in full compliance.

A.2.6 Section 5

You are not required to accept this License, since you have not signed it. However, nothing else grants you permission to modify or distribute the Program or its derivative works. These actions are prohibited by law if you do not accept this License. Therefore, by modifying or distributing the Program (or any work based on the Program), you indicate your acceptance of this License to do so, and all its terms and conditions for copying, distributing or modifying the Program or works based on it.

A.2.7 Section 6

Each time you redistribute the Program (or any work based on the Program), the recipient automatically receives a license from the original licensor to copy, distribute or modify the Program subject to these terms and conditions. You may not impose any further restrictions on the recipients' exercise of the rights granted herein. You are not responsible for enforcing compliance by third parties to this License.

A.2.8 Section 7

If, as a consequence of a court judgment or allegation of patent infringement or for any other reason (not limited to patent issues), conditions are imposed on you (whether by court order, agreement or otherwise) that contradict the conditions of this License, they do not excuse you from the conditions of this License. If you cannot distribute so as to satisfy simultaneously your obligations under this License and any other pertinent obligations, then as a consequence you may not distribute the Program at all. For example, if a patent license would not permit royalty-free redistribution of the Program by all those who receive copies directly or indirectly through you, then the only way you could satisfy both it and this License would be to refrain entirely from distribution of the Program.

If any portion of this section is held invalid or unenforceable under any particular circumstance, the balance of the section is intended to apply and the section as a whole is intended to apply in other circumstances.

It is not the purpose of this section to induce you to infringe any patents or other property right claims or to contest validity of any such claims; this section has the sole purpose of protecting the integrity of the free software distribution system, which is implemented by public license practices. Many people have made generous contributions to the wide range of software distributed through that system in reliance on consistent application of that system; it is up to the author/donor to decide if he or she is willing to distribute software through any other system and a licensee cannot impose that choice.

This section is intended to make thoroughly clear what is believed to be a consequence of the rest of this License.

A.2.9 Section 8

If the distribution and/or use of the Program is restricted in certain countries either by patents or by copyrighted interfaces, the original copyright holder who places the Program under this License may add an explicit geographical distribution limitation excluding those countries, so that distribution is permitted only in or among countries not thus excluded. In such case, this License incorporates the limitation as if written in the body of this License.

A.2.10 Section 9

The Free Software Foundation may publish revised and/or new versions of the General Public License from time to time. Such new versions will be similar in spirit to the present version, but may differ in detail to address new problems or concerns.

Each version is given a distinguishing version number. If the Program specifies a version number of this License which applies to it and "any later version", you have the option of following the terms and conditions either of that version or of any later version published by the Free Software Foundation. If the Program does not specify a version number of this License, you may choose any version ever published by the Free Software Foundation.

A.2.11 Section 10

If you wish to incorporate parts of the Program into other free programs whose distribution conditions are different, write to the author to ask for permission. For software which is copyrighted by the Free Software Foundation, write to the Free Software Foundation; we sometimes make exceptions for this. Our decision will be guided by the two goals of preserving the free status of all derivatives of our free software and of promoting the sharing and reuse of software generally.

A.2.12 NO WARRANTY Section 11

BECAUSE THE PROGRAM IS LICENSED FREE OF CHARGE, THERE IS NO WARRANTY FOR THE PROGRAM, TO THE EXTENT PERMITTED BY APPLICABLE LAW. EXCEPT WHEN OTHERWISE STATED IN WRITING THE COPYRIGHT HOLDERS AND/OR OTHER PARTIES PROVIDE THE PROGRAM "AS IS" WITHOUT WARRANTY OF ANY KIND, EITHER EXPRESSED OR IMPLIED, INCLUDING, BUT NOT LIMITED TO, THE IMPLIED WARRANTIES OF MERCHANTABILITY AND FITNESS FOR A PARTICULAR PURPOSE. THE ENTIRE RISK AS TO THE QUALITY AND PERFORMANCE OF THE PROGRAM IS WITH YOU. SHOULD THE PROGRAM PROVE DEFECTIVE, YOU ASSUME THE COST OF ALL NECESSARY SERVICING, REPAIR OR CORRECTION.

A.2.13 Section 12

IN NO EVENT UNLESS REQUIRED BY APPLICABLE LAW OR AGREED TO IN WRITING WILL ANY COPYRIGHT HOLDER, OR ANY OTHER PARTY WHO MAY MODIFY AND/OR REDISTRIBUTE THE PROGRAM AS PERMITTED ABOVE, BE LIABLE TO YOU FOR DAMAGES, INCLUDING ANY GENERAL, SPECIAL, INCIDENTAL OR CONSEQUENTIAL DAMAGES ARISING OUT OF THE USE OR INABILITY TO USE THE PROGRAM (INCLUDING BUT NOT LIMITED TO LOSS OF DATA OR DATA BEING RENDERED INACCURATE OR LOSSES SUSTAINED BY YOU OR THIRD PARTIES OR A FAILURE OF THE PROGRAM TO OPERATE WITH ANY OTHER PROGRAMS), EVEN IF SUCH HOLDER OR OTHER PARTY HAS BEEN ADVISED OF THE POSSIBILITY OF SUCH DAMAGES.

END OF TERMS AND CONDITIONS

A.3 How to Apply These Terms to Your New Programs

If you develop a new program, and you want it to be of the greatest possible use to the public, the best way to achieve this is to make it free software which everyone can redistribute and change under these terms.

To do so, attach the following notices to the program. It is safest to attach them to the start of each source file to most effectively convey the exclusion of warranty; and each file should have at least the "copyright" line and a pointer to where the full notice is found.

<one line to give the program's name and a brief idea of what it does.> Copyright (C)
<year> <name of author>

This program is free software; you can redistribute it and/or modify it under the terms of the GNU General Public License as published by the Free Software Foundation; either version 2 of the License, or (at your option) any later version.

This program is distributed in the hope that it will be useful, but WITHOUT ANY WARRANTY; without even the implied warranty of MERCHANTABILITY or FITNESS FOR A PARTICULAR PURPOSE. See the GNU General Public License for more details.

You should have received a copy of the GNU General Public License along with this program; if not, write to the Free Software Foundation, Inc., 59 Temple Place, Suite 330, Boston, MA 02111-1307 USA

Also add information on how to contact you by electronic and paper mail.

If the program is interactive, make it output a short notice like this when it starts in an interactive mode:

Gnomovision version 69, Copyright (C) year name of author Gnomovision comes with ABSOLUTELY NO WARRANTY; for details type 'show w'. This is free software, and you are welcome to redistribute it under certain conditions; type 'show c' for details.

The hypothetical commands 'show w' and 'show c' should show the appropriate parts of the General Public License. Of course, the commands you use may be called something other than 'show w' and 'show c'; they could even be mouse-clicks or menu items—whatever suits your program.

You should also get your employer (if you work as a programmer) or your school, if any, to sign a "copyright disclaimer" for the program, if necessary. Here is a sample; alter the names:

Yoyodyne, Inc., hereby disclaims all copyright interest in the program 'Gnomovision' (which makes passes at compilers) written by James Hacker.

<signature of Ty Coon>, 1 April 1989 Ty Coon, President of Vice

This General Public License does not permit incorporating your program into proprietary programs. If your program is a subroutine library, you may consider it more useful to permit linking proprietary applications with the library. If this is what you want to do, use the GNU Library General Public License instead of this License.

GLOSSARY

Access Control List (ACL)

A detailed list of permissions granted to users or groups with respect to file and network resource access. See Chapter 13, “File, Directory and Share Access Controls”, for details.

Active Directory Service (ADS)

A service unique to Microsoft Windows 200x servers that provides a centrally managed directory for management of user identities, and computer objects, as well as the permissions each user or computer may be granted to access distributed network resources. ADS uses Kerberos-based authentication and LDAP over Kerberos for directory access.

Common Internet File System (CIFS)

The new name for SMB. Microsoft renamed the SMB protocol to CIFS during the Internet hype in the nineties. At about the time that the SMB protocol was renamed to CIFS, an additional dialect of the SMB protocol was in development. The need for the deployment of the NetBIOS layer was also removed, thus paving the way for use of the SMB protocol natively over TCP/IP (known as NetBIOS-less SMB or “*naked*” TCP transport).

Common UNIX Printing System (CUPS)

A recent implementation of a high capability printing system for UNIX developed by . <<http://www.easysw.com/>> The design objective of CUPS was to provide a rich print processing system that has built-in intelligence that is capable of correctly rendering (processing) a file that is submitted for printing even if it was formatted for an entirely different printer.

Domain Master Browser (DMB)

The Domain Master Browser maintains a list of all the servers that have announced their services within a given workgroup or NT domain. See Section 9.4.1 for details.

Domain Name Service (DNS)

A protocol by which computer host names may be resolved to the matching IP address/es. DNS is implemented by the Berkeley Internet Name Daemon. There exists a recent version of DNS that allows dynamic name registration by network clients or by a DHCP server. This recent protocol is known as Dynamic DNS (DDNS).

Dynamic Host Configuration Protocol (DHCP)

A protocol that was based on the BOOTP protocol that may be used to dynamically assign an IP address, from a reserved pool of addresses, to a network client or device. Additionally, DHCP may assign all network configuration settings and may be used to register a computer name and its address with a Dynamic DNS server.

Extended Meta-file Format (EMF) An intermediate file format used by Microsoft Windows-based servers and clients. EMF files may be rendered into a page description language by a print processor.

Graphical Device Interface (GDI)

Device Independent format for printing used by Microsoft Windows. It is quite similar to what PostScript is for UNIX. Printing jobs are first generated in GDI and then converted to a device-specific format. See Section 19.4.1 for details.

Group Identifier (GID)

The UNIX system Group Identifier; on older systems a 32-bit unsigned integer and on newer systems an unsigned 64-bit integer. The GID is used in UNIX-like operating systems for all group level access control.

Internet Print Protocol (IPP)

An IETF standard for network printing. CUPS implements IPP.

Key Distribution Center (KDC)

The Kerberos authentication protocol makes use of security keys (also called a ticket) by which access to network resources is controlled. The issuing of Kerberos tickets is effected by a KDC.

NetBIOS Extended User Interface (NetBEUI)

Very simple network protocol invented by IBM and Microsoft. It is used to do NetBIOS over ethernet with low overhead. NetBEUI is a non-routable protocol.

Network Basic Input/Output System (NetBIOS)

NetBIOS is a simple application programming interface (API) invented in the eighties that allows programs to send data to certain network names. NetBIOS is always run over another network protocol such as IPX/SPX, TCP/IP, or Logical Link Control (LLC). NetBIOS run over LLC is best known as NetBEUI (The NetBIOS Extended User Interface — a complete misnomer!).

NetBT (NBT)

Protocol for transporting NetBIOS frames over TCP/IP. Uses ports 137, 138 and 139. NetBT is a fully routable protocol.

Local Master Browser (LMB)

The Local Master Browser maintains a list of all servers that have announced themselves within a given workgroup or NT domain on a particular broadcast isolated subnet. See Section 9.4.1 for details.

Printer Command Language (PCL)

A printer page description language that was developed by Hewlett Packard and is in common use today.

Portable Document Format (PDF) A highly compressed document format, based on postscript, used as a document distribution format that is supported by Web browsers as well as many applications. Adobe also distribute an application called “*acrobat*” which is a PDF reader.

Page Description Language (PDL)

A language for describing the layout and contents of a printed page. The best-known PDLs are Adobe PostScript and Hewlett-Packard PCL (Printer Control Language), both of which are used to control laser printers.

PostScript Printer Description (PPD)

PPD's specify and control options supported by postscript printers, such as duplexing, stapling, DPI, ... See also Section 19.4.4. PPD files can be read by printing applications to enable correct postscript page layout for a particular postscript printer.

Server Message Block (SMB)

SMB was the original name of the protocol 'spoken' by Samba. It was invented in the eighties by IBM and adopted and extended further by Microsoft. Microsoft renamed the protocol to CIFS during the Internet hype in the nineties.

User IDentifier (UID)

The UNIX system User Identifier; on older systems a 32-bit unsigned integer and on newer systems an unsigned 64-bit integer. The UID is used in UNIX-like operating systems for all user level access control.

Universal Naming Convention (UNC)

A syntax for specifying the location of network resources (such as file shares). The UNC syntax was developed in the early days of MS DOS 3.x and is used internally by the SMB protocol.

SUBJECT INDEX

- ”Printers” folder, 305, 310, 319
- ”raw” printing, 269
 - /etc/cups/mime.convs, 270
 - /etc/cups/mime.types, 270
 - /etc/host.conf, 417
 - /etc/hosts, 417
 - /etc/krb5.conf, 73, 163, 167
 - /etc/ldap.conf, 168, 170
 - /etc/nsswitch.conf, 162, 165, 170, 418
 - /etc/openldap/slapd.conf, 23
- 8.3 file names, 173
- Account Controls, 380
- ACLs, 171
 - File System, 174
 - POSIX, 171, 172
 - share, 172
 - Windows, 172
- Active Directory, 72, 158, 159, 165, 209
- AD4UNIX, 161
- ADAM, 166
- add group script, 21, 27, 156, 157
- add machine script, 21, 27, 53, 67, 68, 78, 92
- add printer command, 255
- add printer wizard, 271
- add user script, 21, 27, 130
- add user to group script, 21, 27
- admin users, 19, 26, 177, 187
- Administrator, 152
- ADS, *see* Active Directory 72, 159, 160, 166
- AFS, 437
- algorithmic mapping, 161
- allow trusted domains, 164
- Amanda, 433
- anonymous
 - print server, 11
 - read-write server, 11
- application/cups.vnd-postscript, 305
- application/octet-stream, 270, 271, 280, 289
- application/pdf, 279, 280
- application/postscript, 305
- application/vnd.cups-raster, 290
- application/vnd.cups-raw, 270
- auth methods, 146, 447
- b-node, 104
- BackupPC, 432
- bad hardware, 123
- BDC, 159, 161
- BIND, 504
- bind interfaces only, 205, 470
- BOBS, 434
- brlock.tdb, *see also* TDB 321
- broadcast, 104
- browse list, 103, 117
- browseable, 12, 15, 19, 26, 48, 82, 221, 226, 228, 230, 235, 267, 301, 344, 345, 350
- browsing problems, 123
- case sensitive, 179, 386
- chpass, 66
- client use spnego, 78
- comment, 3, 10, 12, 15, 19, 26, 48, 80, 82, 226, 228, 229, 235, 267, 268, 301, 344, 345, 350, 467
- Config.POL, 377
- configure, 485
- connections.tdb, *see also* TDB 321
- core files, 481
- create mask, 15, 19, 26, 46, 178, 184, 498
- csc policy, 179
- CUPS
 - Page Accounting, 330
 - quotas, 330
- CUPS-PPD, 325
- cupsaddsmb, 271, 300, 304, 306, 308, 310
- cupsomatic, 277, 278, 287, 291, 325
- daemon, 489
- DDK, 299, 302
- debug, 481
- debug level, 474, 500
- debuglevel, 480
- default case, 179

- default profile, 393, 400
- delete group script, 21, 27
- delete printer command, 255
- delete roaming profiles, 398
- delete user from group script, 27
- delete user script, 21, 27
- DFS, *see* MS-DFS, Distributed File Systems 439
- DHCP, 416
- diagnostic, 169
- diff, 481
- directory mask, 46, 178, 498
- directory security mask, 184, 185
- Directory Separators, 173
- disable spoolss, 12, 15, 18
- display charset, 426, 427, 430, 463
- Distributed File Systems, 437
- DMC, 162
- DMS, 162
- DNS, 105, 422
 - Active Directory, 106
 - Dynamic, 416, 504
- dns proxy, 103
- domain admin group, 150
- Domain Admins group, 153
- domain join, 163
- domain logons, 21, 27, 28, 45–48, 58, 61, 400
- domain master, 21, 27, 28, 46–48, 58, 61, 62, 103, 109–112
- Domain Member, 33, 160
 - joining, 33
- Domain Member Client, *see* DMC 162
- Domain Member Server, *see* DMS 162
- domain security, 40, 161
- Domain Users group, 157
- dont descend, 179
- dos charset, 426, 427, 429–431
- dos filemode, 178
- dos filetime resolution, 179
- dos filetimes, 179
- Drive Identification, 173

- editreg, 381
- EMF, 272, 294, 295
- encapsulating, 104
- encrypt passwords, 36, 70, 72, 134, 140, 410, 441, 472, 473
- encrypted passwords, 125, 127, 144
- enhanced browsing, 103
- enumports command, 259
- EPM, *see* ESP meta packager 301
- error message, 164
- ESC/P, 295
- ESP
 - Ghostscript, 278, 279, 291
 - meta packager, 301
 - Print Pro, 293, 303
- Event Viewer, 371
- example1: parameter, 345
- example: parameter, 345
- Extended Attributes, 171

- failed join, 163, 166
- fake oplocks, 179
- File Naming Conventions, 174
- File System, 172
 - case sensitivity, 173
 - feature comparison, 173
 - UNIX, 172
 - Windows, 172
- flush name cache, 122
- foo:domain column, 145
- foo:fullname column, 145
- foo:lanman pass column, 145
- foo:mysql database, 145
- foo:mysql password, 145
- foo:mysql user, 145
- foo:nt pass column, 145
- foo:unknown 3 column, 145
- foomatic, 277, 278, 287, 291, 323, 324
- foomatic-rip, 291, 323, 325
- force create mode, 178, 184, 187, 188
- force directory mode, 178, 184, 187, 188
- force directory security mode, 178, 184, 185
- force group, 12, 15, 176, 177, 187
- force security mode, 178, 184, 185
- force user, 12, 15, 176, 177, 187, 194
- ftp, 484

- gdb, 481
- GDI, 272, 294, 295
- genlogon.pl, 374
- getent, 165
- GhostScript, *see also* PostScript 274, 275

- Ghostscript
 - ESP, *see* ESP GhostScript 276
- GID, 150, 152, 158, 159
- GID range, 209
- GPG, 484
- GPOs, 376, 378–380, 396
- group policies, 376
- group policy objects, *see* GPOs 376
- group profiles, 392
- groupadd, 151
- groupadd limitations, 155
- groupdel, 151
- groups
 - domain, 153
 - mapping, 150
 - nested, 157
- guest account, 119, 123, 229
- guest ok, 4, 10, 12, 15, 19, 26, 48, 82, 177, 226, 229, 230, 235, 267, 268, 301
- guest only, 80

- h-node, 104
- Heimdal, 163
- Heimdal kerberos, 163, 167
- hide dot files, 179
- hide files, 179
- hide unreadable, 178
- hide unwriteable files, 178
- host msdfs, 216, 217
- hosts allow, 205, 206, 226, 230, 268, 470
- hosts deny, 205, 206, 226, 230, 268, 470
- Hybrid, 104

- identity, 158
- IDMAP, 150, 158, 164
- idmap backend, 61, 62, 131, 160, 449
- idmap gid, 18, 21, 27, 28, 130, 150, 160, 164, 209, 360, 369, 414, 449
- idmap uid, 18, 21, 27, 28, 130, 150, 160, 164, 209, 360, 369, 414, 449
- idmap_rid, 160, 164
- ifconfig, 488
- imprints, 271
- include, 480
- inetd, 470, 487
- initGroups.sh, 22, 156, 454
- Interdomain Trusts, 209
 - Completing, 211
 - creating, 210
 - Facilities, 211
 - interfaces, 112, 119, 205, 470, 471, 488
 - interoperability, 158
 - invalid users, 176, 177
 - IPP, 308
 - ISC
 - DHCP, 503
 - DNS, 503
 - join, 163

 - KDC, 72
 - Kerberos, 72
 - /etc/krb5.conf, 73
 - kerberos, 163
 - kernel oplocks, 196
 - kinit, 74
 - KRB, 163

 - large domain, 165
 - LDAP, 160, 209
 - ldap admin dn, 27, 28, 61, 77, 140
 - ldap delete dn, 140
 - ldap filter, 140
 - ldap group suffix, 27, 28, 140
 - ldap idmap suffix, 27, 28, 61, 77, 140, 449
 - ldap machine suffix, 27, 28, 140
 - ldap passwd sync, 27, 28, 140, 143
 - ldap ssl, 27, 28, 140, 141
 - ldap suffix, 27, 28, 61, 140
 - ldap user suffix, 27, 28, 140
 - level2 oplocks, 196
 - libnss_wins.so, 418
 - Links
 - hard, 174
 - soft, 174
 - Linuxprinting.org, 323
 - lm announce, 103
 - lm interval, 103
 - LMB, *see* Local Master Browser 104, *see* Local Master Browser 113
 - LMHOSTS, 420
 - load printers, 222–224, 226, 227, 267, 268, 301
 - local master, 46, 103, 109–111
 - Local Master Browser, 104, 113
 - locking, 190
 - locking.tdb, *see also* TDB 321

- log file, 480
- log files
 - monitoring, 468
- log level, 78, 118, 345, 346, 480
- logon drive, 21, 27, 28, 46, 388, 400
- logon home, 21, 27, 28, 46, 142, 149, 384, 385, 388, 390
- logon path, 21, 27, 28, 46, 147, 384, 385, 387, 388, 390, 400
- logon script, 21, 27, 28, 46, 147
- lpadmin, 323, 330
- lppause command, 267, 296, 335
- lpq cache time, 226, 228
- lpq command, 267, 335
- lpresume command, 267, 335
- lprm command, 267, 335
- lpstat, 321
- Lustre, 437

- m-node, 104
- MAC Addresses, 416
- Machine Trust Accounts, 42, 62, 65
 - creating, 65
- make, 485
- mandatory profiles, 392
- map to guest, 236, 255, 339
- max log size, 346, 480
- max print jobs, 226, 227
- max xmit, 500
- messages.tdb, *see also* TDB 321
- MIME, 279–281, 289
 - filters, 279
 - raw, 13, 82, 270
- minimal configuration, 2
- MIT, 163
- MIT kerberos, 163, 167
- MMC, 161
- MS Windows SID, 159
- MS-DFS, 439
- msdfs root, 216, 217

- name resolve order, 103, 117
- nbtstat, 420
- net
 - groupmap, 22, 155, 454
 - rpc, 17, 33, 56, 453
- net ads join, 164
- NetBIOS, 102, 104, 105, 415, 419
 - netbios name, 3, 10, 12, 15, 18, 21, 27, 28, 46, 47, 80, 82, 140, 217
 - NetBIOS-less, 105
 - network client, 158
 - Nexus.exe, 41, 67, 371
 - NFS, 437
 - nmbd, 3, 14, 17
 - nmblookup, 420
 - node-type, 104
 - NoMachine.Com, 372
 - NSS, 165
 - nss_ldap, 161, 170
 - nt acl support, 178, 182, 183, 498
 - NT4, 159
 - NT4 Domain, 158
 - NTConfig.POL, 377, 380, 381, 394
 - ntdrivers.tdb, *see also* TDB 321
 - ntforms.tdb, *see also* TDB 321
 - NTFS, 172
 - ntprinters.tdb, *see also* TDB 321
 - NTUser.DAT, 381

 - obey pam restrictions, 409, 410
 - office server, 14
 - on-the-fly, 161
 - one domain, 158
 - only user, 177, 208
 - OpenGFS, 437
 - oplock break contention limit, 197
 - oplock break wait time, 194, 197
 - oplock contention limit, 194
 - oplocks, 196
 - os level, 21, 27, 28, 46, 103, 109–112, 400
 - os2 driver map, 495

 - p-node, 104
 - PADL, 160, 168
 - page_log, 331
 - passdb backend, 14, 21, 27, 28, 46, 58, 59, 61, 65, 80, 82, 127, 133, 134, 140, 144–146, 410, 441, 447
 - password level, 37, 472, 496, 501
 - password server, 35, 36, 51, 70, 72, 473
 - patch, 481
 - path, 3, 10, 12, 15, 19, 26, 46, 48, 80, 82, 217, 222, 226, 228–230, 234–236, 267, 268, 296, 301, 334, 342, 344, 345, 350, 467, 472, 498

- PCL, 272, 273, 295, 297
- pdbedit, 21, 127, 131–133, 145, 447, 453, 456
- PDC, 159, 161
- PDF, 273, 277
- pdf, 280
- PDL, 272, 274
- permissions
 - file/directory ACLs, 181
 - share, 176
 - share ACLs, 177
 - UNIX file and directory, 172
- PGP, 485
- PJL, 297, 305, 331
- point 'n' print, 270, 271, 287, 306, 310, 320
- PostScript, 272, *see also* Ghostscript 272, 273, 274, 281, 295, 297, 299, 300
 - RIP, 274
- PPD, 274, 276, 290, 298, 299, 310
 - CUPS, *see* CUPS-PPD 325
- preferred master, 21, 27, 28, 46, 103, 109–112, 473
- preserve case, 386
- print command, 227, 230–232, 267, 268, 296, 335
- printable, 12, 15, 19, 26, 82, 222, 226, 228–230, 267, 268, 301
- printcap, 231, 266, 268, 270, 296, 335
- printcap name, 12, 15, 18, 21, 27, 28, 82, 226, 227, 267, 268, 301
- printer admin, 15, 19, 26, 82, 226–229, 235, 236, 238, 248–250, 252, 254, 267, 268, 301, 315, 341
- printing, 12, 15, 18, 21, 27, 28, 82, 222, 225–227, 230–232, 266–268, 270, 296, 301, 335
- printing.tdb, *see also* TDB 321
- PrintPro, *see* ESP Print Pro 293
- profile acls, 26
- public, 222, 226, 229, 267, 268, 301
- queue resume command, 267
- queuepause command, 267
- raw printing, 13, 82, 270
- read list, 177
- read only, 4, 10, 12, 15, 19, 26, 46, 179, 226, 229, 235, 236, 301, 467, 498
 - server, 9
- read raw, 501
- read size, 500
- realm, 34, 72, 164, 167
- Relative Identifier, *see* RID 153
- remote announce, 104, 105, 108, 113, 118
- remote browse sync, 104, 105, 108, 113
- replication, 41
 - browse lists, 119
 - SAM, 43, 55–57, 61, 63
 - WINS, 104, 114, 115
- response, 165
- rfc2307bis, 169
- RID, 153, 160, 161, 164
- RID base, 161
- roaming profiles, 385
- root preexec, 453
- rpcclient
 - adddriver, 307, 308, 312, 313, 315, 317
 - enumdrivers, 312, 318
 - enumports, 312
 - enumprinters, 312, 315, 318, 319, 321
 - getdriver, 314, 316, 318
 - getprinter, 314, 316, 318, 321
 - setdriver, 305, 307, 308, 312, 315, 318
- rsync, 484
- rundll32, 375
- SAM, 41, 42, 64, 357
- SAM backend
 - LDAP, 55
 - ldapsam, 56, 126, 131, 135
 - ldapsam_compat, 125
 - mysqsam, 126, 143
 - non-LDAP, 55
 - smbpasswd, 125, 134
 - tdbsam, 56, 126, 135
 - xmsam, 126, 145
- samba-ldap-init.ldif, 24
- samba-to-samba trusts, 209
- schannel, 53
- schema, 169
- SCSI, 439
- secrets.tdb, *see also* TDB 321
- security, 10, 12, 18, 31–36, 38, 44, 46, 47, 51, 70–73, 80, 82, 140, 306, 337, 400, 447, 473, 496

- security mask, 178, 184, 185
- Security Mode, 31
- Server Manager, 66, 67, 371
- Server Type, 31
 - Domain Controller, 20
 - Domain Member, 16, 33, 62, 64
 - Stand-alone, 9
- Server Types, 158
- sessionid.tdb, *see also* TDB 321
- set primary group script, 27
- SFU, 170
- SFU 3.5, 161
- share.info.tdb, *see also* TDB 321
- short preserve case, 179, 386
- Short-Cuts, 174
- show add printer wizard, 12, 15, 18, 226, 227, 255
- SID, 40, 52, 60, 127, 152, 158–161, 164, 391, 453
- signing, 53
- simple configuration, 4
- Single Sign On, 304
- slow browsing, 123
- SMB-based messaging, 104
- smbclient, 76, 470, 471
- smbd, 3, 14, 17
- smbgrpadd.sh, 155
- socket options, 499, 500
- spooling
 - central, 269
 - peer-to-peer, 269
- spooling-only, 269
- SRVTOOLS.EXE, 67, 371
- stand-alone server, 158
- starting samba
 - nmbd, 3, 14, 17
 - smbd, 3, 14, 17
 - winbindd, 3, 17, 353
- strict locking, 190
- Subversion, 483
- SVN
 - web, 483
- swat, 4
 - enable, 461
 - security, 462
- System Policy Editor, 377, 379
- TDB, 321
 - backing up, *see* tdbbackup 322
 - tdbbackup, 322
 - template homedir, 360, 365, 366
 - template shell, 360
 - test: parameter, 345
 - testparm, 468
 - text/plain, 280
 - trusts, 209
- UDP, 104
- UID, 150, 158–160
- UID range, 209
- unexpected.tdb, *see also* TDB 321
- unicast, 104
- unix charset, 426, 427, 429, 430
- use client driver, 12, 15, 19, 82, 226, 228, 270, 309
- use sendfile, 18
- user, 33, 472
- User Accounts
 - Adding/Deleting, 132, 141
- User Management, 132, 141
- User Manager, 213, 371
- useradd, 66
- username, 177
- username level, 37
- username map, 27, 28, 68
- users, 208
- valid users, 15, 19, 26, 176, 177, 205, 208, 472
- veto files, 179
- veto oplock files, 196, 197
- vfs objects, 344, 345, 350
- vfs option, 429
- vipw, 66
- WebClient, 123
- winbind, 159, 162, 209
 - winbind enum groups, 360
 - winbind enum users, 360
 - winbind separator, 360, 361
 - winbind use default domain, 18
 - winbindd, 3, 17, 62, 158, 353
- Windows, 158
- windows registry settings
 - default profile locations, 395, 397
 - profile path, 387
 - roaming profiles, 385

Windows Security Identifiers, *see* SID 158
WINS, 103, 104, 422, 504
wins hook, 103
wins proxy, 103
wins server, 80, 103, 114, 115, 423
wins support, 103, 114, 115, 423
workgroup, 3, 4, 10, 12, 15, 18, 21, 27, 28,
 33, 46, 47, 51, 58, 61, 70, 80, 82,
 118, 140
writable, 222, 226, 229, 230, 267, 268, 301
write list, 26, 46, 177, 235, 236, 301
write raw, 501
writeable, 344, 345, 350
WYSIWYG, 272

X Window System, 273
xinetd, *see* inetd 470, 488
Xprint, 273